

Network Camera

User's Manual

Model No. **TN60**
TN60W



Copyright

© 2013 Compro Technology, Inc. All rights reserved.

Trademark

Compro, and the Compro logo are trademarks of Compro Technology, Inc. C4Home and C4Home logo are registered trademarks of AVSecur Technology, Inc. Microsoft, Windows Vista, Windows and the Windows logo are trademarks of the Microsoft group of companies. SD, SDHC and microSDHC Logos are trademarks of SD-3C, LLC. Apple, Apple Logo, Mac, Mac OS, iPad, iPhone are trademarks of Apple Inc., registered in the U.S. and other countries. Android is a registered trademark of Google, Inc. Other names and marks are trademarks of their respective owners.

Restriction

No part of this document may be copied or reproduced in any form or by any means without the prior written consent of Compro Technology, Inc.

Disclaimer

Compro Technology makes no warranties with respect to this documentation and disclaims any implied warranties of merchantability, quality, or fitness for any particular purpose. The information in this document is subject to change without notice. COMPRO reserves the right to make revisions to this publication without obligation to notify any person or entity of any such changes.

Revision History

2013/06/10 Original Version (V1.04)

Compro Technology, Inc.

www.comprosecurity.com

Tel. +886 2 2918 0169, Fax +886 2 2915 2389

4F, No.12, Alley 6, Lane 45, Pao Shin Road,

Hsintien District, New Taipei City 231, Taiwan

Support e-mail: support@comprousa.com



Contents

Chapter 1: Important Notices	1-1
Regulatory Notice	1-1
FCC Interference Statement	1-1
Operation Safety	1-1
About this Manual	1-2
Conventions in this Manual	1-2
Chapter 2: Product Overview	2-1
Key Features	2-1
Package Contents	2-1
Hardware Overview	2-2
LED Status Indicator	2-3
Chapter 3: Installation	3-1
Connect the Cables	3-1
Setup Network Camera from iPhone/Android phone or tablet	3-1
Setup TN60W Network Camera from WPS Connection	3-2
Setup Network Camera from PC and Installation CD	3-4
Mount the Camera	3-10
Chapter 4: Accessing the Camera	4-1
Ways of Viewing Live Video	4-1
Instant Monitoring	4-2
From C4Home iPhone/Android App	4-2
From Android Phone/Tablet App	4-5
From C4Home Website	4-5
Accessing via PC Web Browser	4-6
Accessing via M-JPEG Mode	4-8
Accessing via 3GPP Mobile Phone	4-9
Chapter 5: Live View (With WebVUer on PC)	5-1
Page Layout	5-1
Icons on Live View Page	5-2
Top Panel	5-2
Left Panel	5-2
Others	5-3
Enable Digital Zoom	5-3
Voice Communication	5-3
Chapter 6: Configuration (From WebVUer)	6-1
Main Setup Page	6-1
Video Settings	6-2
Video Mode	6-2
Stream Setting	6-2
Video Buffer	6-2
Video Preference	6-2
Camera Settings	6-3
Video Properties	6-3
Backlight Compensation	6-3
Flickerless	6-3
Low Light Behavior	6-3
LED Indicator	6-4
IR Light Control	6-4
Embed Text and Image	6-4
Flip Mode	6-4
Audio Settings	6-5
User Settings	6-5

Network Settings	6-6
Ethernet	6-6
Wireless	6-6
Network Diagnostic	6-6
Network Bandwidth	6-7
Advanced	6-7
DDNS	6-8
UPnP	6-8
RTP	6-8
QoS	6-8
Event Setup	6-9
Event Server Setup	6-9
Trigger Setup	6-11
Motion Detection Setup	6-11
Date Setup	6-11
Multi-Camera	6-12
OSD Setting	6-12
Chapter 7: Event Viewer	7-1
Chapter 8: Maintenance	8-1
Information	8-1
Log	8-1
Maintenance	8-1
Reboot Camera	8-1
Profile Management	8-1
Reset All Settings to Default	8-2
Firmware Update	8-2
Chapter 9: Troubleshooting	9-1
Reset to Factory Default Settings	9-1
Trouble with the ActiveX Client	9-2
No user interface in the browser:	9-2
Trouble with Remote Viewing on Browser	9-4
DDNS Configuration	9-6
Symptoms, Causes and Solutions	9-7
Contacting Compro Technical Support	9-13
Chapter 10: Technical Specifications	10-1
TN60/TN60W Technical Specifications	10-1
Chapter 11: Appendix	11-1
Examples of Port Forwarding Setup on Routers	11-1
Abocom WAA813rn Port Forwarding Setup	11-1
ASUS RT-N12 Virtual Server Setup	11-1
D-Link DIR-655 Virtual Serve Setup	11-2
TP-LINK wr1043n Virtual Server Setup	11-3

Chapter 1: Important Notices

Regulatory Notice

This device complies with Part 15 of the FCC Rules. Operation is subject to the following two conditions: (1) This device may not cause harmful interference, and (2) This device must accept any interference received, including interference that may cause undesired operation.

FCC Interference Statement

This equipment has been tested and found to comply with the limits for a Class B digital device, pursuant to Part 15 of the FCC Rules. These limits are designed to provide reasonable protection against harmful interference in a residential installation.

This equipment generates, uses and can radiate radio frequency energy and, if not installed and used in accordance with the instructions, may cause harmful interference to radio communications. However, there is no guarantee that interference will not occur in a particular installation. If this equipment does cause harmful interference to radio or television reception, which can be determined by turning the equipment off and on, the user is encouraged to try to correct the interference by one of the following measures:

- Reorient or relocate the receiving antenna.
- Increase the separation between the equipment and receiver.
- Connect the equipment into an outlet on a circuit different from that to which the receiver is connected.
- Consult the dealer or an experienced radio/TV technician for help.

To assure continued compliance, any changes or modifications not expressly approved by the party responsible for compliance could void the user's authority to operate this equipment.

Operation Safety

Before starting using the camera, please read and follow the steps below to protect your IP camera.

- Please place the IP camera on a level surface and out of direct sun shine.
- Please keep the IP camera indoors and away from water, dust, humidity or magnetic products.
- Please do not drop the IP Camera body to the floor; it may cause the damage to main parts.
- Please do not disassemble or remodel the product; it may cause damage or fire.
- Do not shake, move or disturb the IP camera when it is in operation, as such actions may result in the malfunction of the device.
- Power off the IP Camera as soon as it is found smoking or smelt unusual.
- Please do not place the IP Camera around the heat sources, such as television or microwave oven.

About this Manual

This manual is only intended for the users of Compro TN60/TN60W network camera.

Conventions in this Manual

While you are using this manual, pay attention to some symbols and notations that are used to draw attention to special situations such as:



Caution!

Information provided here is critical to prevent damage to the product or injury to the user.



Important:

Here it provides instructions that a user must follow in order to complete a task.



Note:

Additional information or tips to help the user operate the product.

Chapter 2: Product Overview

Key Features

The small and compact Compro TN60 cloud network camera offers vividly clear image quality and a bounty of practical surveillance features. Its small size makes it an ideal choice for securing homes, restaurants, small offices, or any place where space is limited.

- Small and functional design
- 10X digital zoom
- H.264 and MJPEG compression
- Dual video streaming
- PIR sensor and IR LEDs
- Exclusive C4Home™ smartphone and tablet app
- Two-way audio with microphone and speaker. Also support smartphone communication
- Smart motion detection
- Upgradable for 802.11 b/g/n wireless LAN

Package Contents

Please check the package contents on your hand. If anything is missing, please don't hesitate to contact your local distributor.

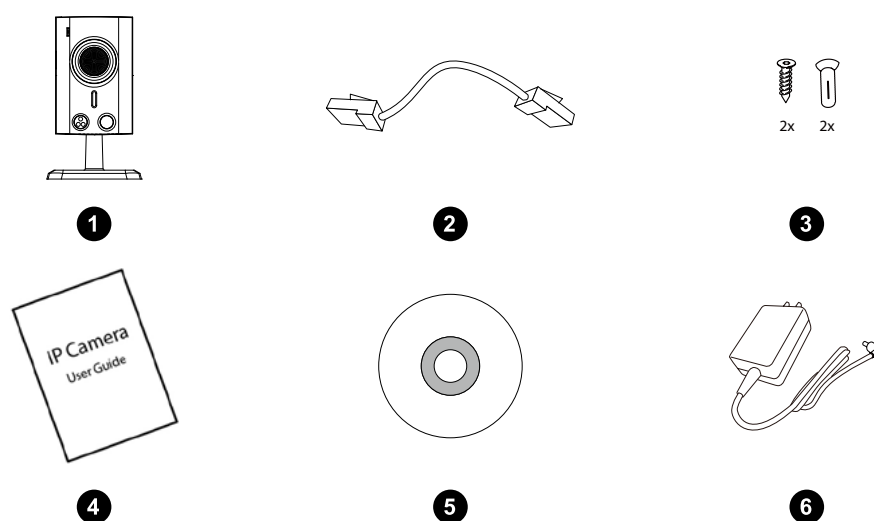

Figure 1-1. Parts list

- 1 Network Camera
- 2 RJ-45 LAN Cable
- 3 Screw for ceiling mount x 2, screw anchor x 2
- 4 Quick Installation Guide
- 5 Installation CD
- 6 Power Adapter (DC5V, 2A)

Hardware Overview

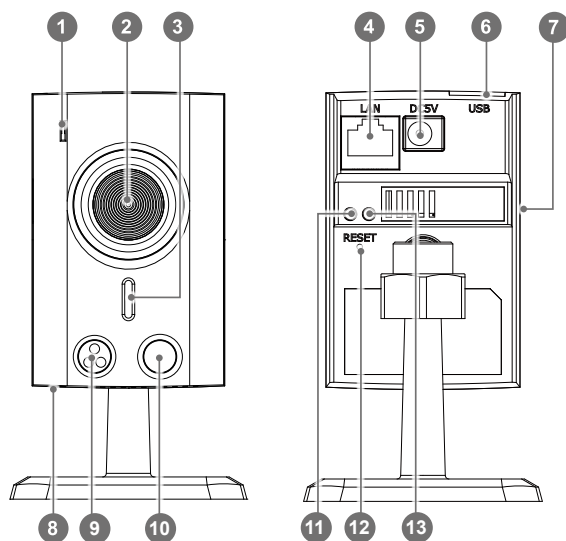

Figure 1-2. Front and rear view

- ① LED status indicator – For indicating system status.
- ② Lens – 2.0 mm, F2.8, fixed iris.
- ③ Speaker – Audio output.
- ④ Ethernet port – Connect to the Ethernet port of your network hub/switch that also connects to your viewing PC.
- ⑤ Power connector – DC 5V/2A power supply.
- ⑥ USB wireless adapter port – Only for use with Compro wireless adapters.
- ⑦ microSD card slot – Insert the microSD/SDHC card for event recording and snapshot.
- ⑧ Microphone pinhole (on the bottom) – For receiving ambient sound.
- ⑨ IR LEDs – Enables night view in pitch darkness.
- ⑩ PIR Sensor – Passive Infrared sensor to detect invader.
- ⑪ Connection status indicator – Blinking yellow indicates network activity over the camera's Ethernet port.
- ⑫ Reset button – Press and hold the button to reset the camera back to factory defaults.
- ⑬ Network speed indicator – Constant green (100Mbps) or unlit (10Mbps).

LED Status Indicator

When you power on the camera, it will start booting procedure. There are one blue LED and one red LED inside the camera case. Depending on the booting status, the LED indicator will be lit in the followings way:

1. About 25 seconds after powering on the IP camera, both the blue LED and red LED indicator will become lit (appears purple).
2. About 35 seconds after powering on the IP camera, the red LED will be turned off.
3. Camera trying to connect to network: both blue & red LED flashing at an interval of 0.5 second.
4. Camera established connection: blue LED constantly on (Red LED off)
5. Camera failed to connect: flashing red LED. (Blue LED off)

Red LED	Blue LED	Indication
On	On	System booting up
Off	On	Successfully established network connection
On	Off	Performing hardware test
Off	Off	Powered off
Blinking (every 0.5 sec.)	Off	Failed to connect to network / failed to establish a WPS connection
Off	Blinking (every 0.5 sec.)	Attempting to establish a WPS connection
Off	Blinking (every 0.2 sec. in a 3-second period)	Successfully established a WPS connection
Blinking (every 0.5 sec.)	Blinking	Attempting to establish network connection

Table 1-1. LED status

Chapter 3: Installation

Connect the Cables

The illustration below shows the basic cabling of your network camera.

Setup Network Camera from iPhone/Android phone or tablet

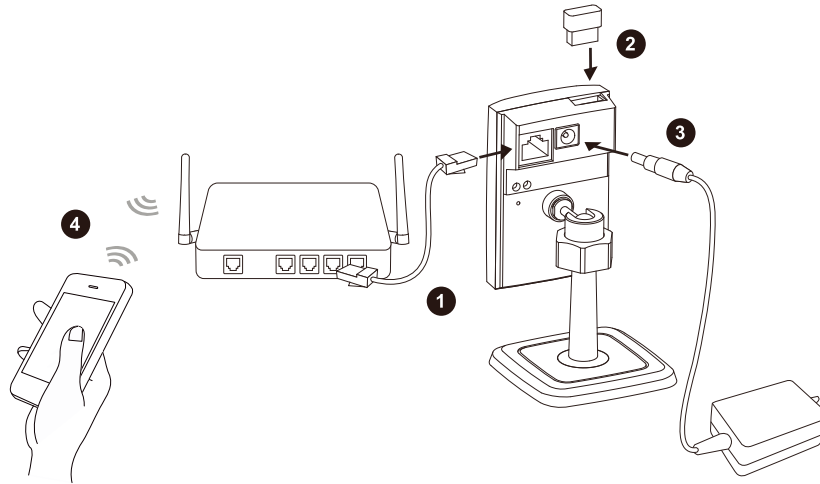

Figure 3-1. Connection of cables

- 1 Connect an Ethernet cable between your network camera and your network switch/router.
- 2 If your package include a wireless adaptor, please plug it into the USB port of network camera for wireless reception. The camera's USB port only supports the wireless adapters from Compro. Do not use any other USB adapters on Compro IP cameras. You must setup the network camera with Ethernet cable connected then go to wireless setup.
- 3 Attach the power adapter to the camera's power connector and connect the power plug to a power outlet. When it power on successfully, the LED indicator will shows blue light.
- 4 Make sure your smartphone is able to go to internet via your wireless router. Then download the C4Home™ app from Apple app store or Google Play and install to your smartphone. Start C4Home™ app and register your personal C4Home™ account.

iPhone



Android



- 5 Login to the C4Home™ account and click "+" to add new camera, we provide 3 ways to add your camera:
- Scan the QR code from the back side of camera, it will automatically add your camera to the list.



- Direct input the camera ID (10 digitals under the QR code) and password (default: admin) to add your camera.
 - Click "iWizard" button on add camera page to search the available network camera from your local network and setup. In this wizard, you can setup camera and wireless adaptor.
- 6 Now you can watch live video of your network camera from your smartphone or tablet.

Setup TN60W Network Camera from WPS Connection

If your wireless router support WPS connection setup, you can use it to setup TN60W network camera directly from WPS and no Ethernet cable required.

- 1 Plug in the power of your TN60W network camera and install the wireless adaptor to camera's USB port. Do not connect the Ethernet cable to the network camera. (If you connect the Ethernet cable, the network camera will running the cable mode.) The LED indicator in the front of network camera will shows blinking red.
- 2 Press the WPS button on the wireless router about 3 sec. to turn on the WPS setup. (The WPS setup maybe vary from different router manufacturers, please refer to the user's manual of your wireless router for WPS setup.)

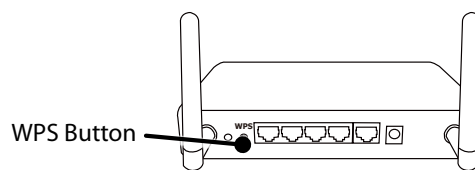

- 3 One-click the RESET button on the network camera within 1 minute. And wait for about 1 minute for the connection between wireless router and network camera.

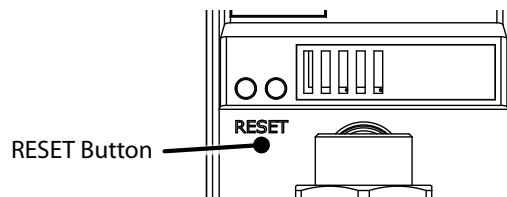

- 4 When the connection is established, the LED indicator will shows blue light.
- 5 Open the C4Home app from your smartphone and add camera to your list.

If the WSP setup is not working, please try to setup the network camera with Ethernet cable connection.

Important:

- With the Compro wireless antenna installed on TN60W model, you can also option for using the wireless connection. Please keep in mind that you can only have one active connection at a given time, either through LAN or wireless network.
- If you connect the IP camera to the Intranet, then the same group of users can share the access of IP camera. Please also ensure that the wireless antenna has been securely installed, or it could lead to unstable connection.
- If the wireless connection drops randomly or plainly seems slow, try bringing your IP camera in closer proximity to the wireless AP/router and then see if the situation improves.
- Having more walls and ceilings between the wirelessly connected Compro camera and your wireless AP/router will negatively affect your wireless connection speed. Generally, the number of walls and ceilings shall be kept in minimum.
- Materials and objects like solid metal, aluminum, steel, water, brick, and concrete will weaken the strength of the wireless signal. Allow the wireless signal from your wirelessly connected camera and your wireless AP/router to pass through open doorways when positioning them.
- The operation of the wireless network may be interfered should there be other 2.4 GHz devices working in the vicinity, e.g. microwave oven, digital cordless camera, etc. You may experience slow frame rate or drops of connection; in such situation, we suggest you try moving the IP camera away from the area or turning off other appliances.
- Since wireless cameras can cause interferences on transmission, you may encounter erratic behavior when there are more than 10 cameras operating in close proximity.
- The default wireless connection method uses 802.11n standard and you should experience a stable connection on your camera within 20 meters of the access point. .



Setup Network Camera from PC and Installation CD

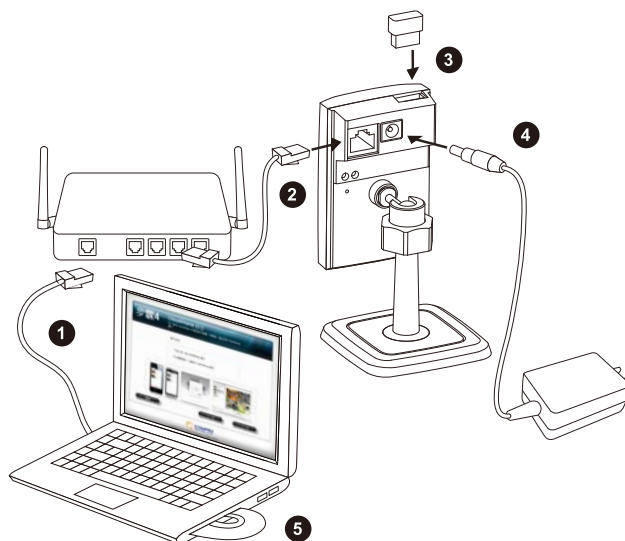

Figure 3-2. Connection of cables

- 1 Connect an Ethernet cable between your PC and your network switch/router.
- 2 Connect an Ethernet cable between your network camera and your network switch/router.
- 3 If your package include a wireless adaptor, please plug it into the USB port of network camera for wireless reception. The camera's USB port only supports the wireless adapters from Compro. Do not use any other USB adapters on Compro IP cameras. You have to setup the network camera with Ethernet cable connected then go to wireless setup.
- 4 Attach the power adapter to the camera's power connector and connect the power plug to a power outlet. When it power on successfully, the LED indicator will shows blue light.
- 5 Complete the cable connection, we provide 2 ways to add your camera:
 - Login to C4Home™ website (www.c4home.com) and add camera to the list. C4Home website not support the wireless setup of network camera. Please use C4Home app or installation CD for wireless setup.
 - Insert the installation CD to your CD/DVD drive, and running the iWizard.exe to install IP camera.

Caution!



- The wireless connection port only supports the Compro wireless adapters ; please do not use other USB adapters on Compro IP camera. Should you remove the wireless adapter during camera operation, you need to power off the camera first before re-plugging it.
- When you unplug the power plug from the wall outlet while the camera is still in operation, wait for 4 seconds before plugging the power plug back in the wall outlet. And avoid too frequent plugging and unplugging of power cable.
- If the power cable and the network cable connected to the camera are not securely fastened, it could lead to unstable connection.

**Note:**

You can add more Compro cloud network camera to your account for management. C4Home™ app allow maximum 16 network cameras installed.

To begin setup, insert the installation CD into your CD-ROM drive, and the iWizard will start automatically.

**Note:**

If Autorun has been disabled in your computer, please browse the contents of the installation CD and double-click on the "iWizard.exe" file to run the setup wizard.

1. Select the language for installation network camera.



Figure 3-3. Language selection

2. Select your camera from the list, and wait until the live video and camera information are displayed on the right. (You can double-check the device name and the MAC ID which are printed on the serial number sticker on the back of the camera and on the package). Click [Next] when you're ready .

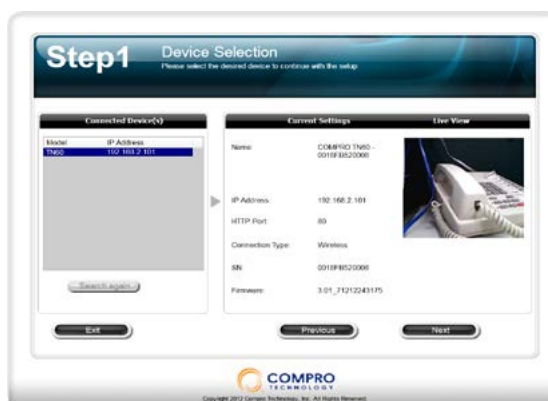

Figure 3-4. Camera selection

- The default password is 'admin.' Enter a new password here (please note down your new password). You can also click [Next] to skip this process.

Figure 3-5. Password setup

- Check the camera name, date and time setting.

Figure 3-6. Camera configuration

- Choose whether to use C4Home service to remotely access your camera. C4Home is a platform for viewing, managing and sharing network cameras over the internet. You may also use a different C4Home server by clicking on [Advanced Settings]. (Default server is www.c4home.com) (If C4Home service is enabled, iDDNS service will not be available for use on the camera.)

Figure 3-7. C4Home setup



Note:

C4Home video streams are encrypted end-to-end and most of the streams are sent through direct channels and don't pass through C4Home server, which helps protect user privacy.

9. (Skip here if you have enabled C4Home service) If you are using floating IP, you can use DDNS service and create a hostname that links to your camera's IP address. Click [Yes] and input an address name. Then click [Check Availability] button.



Figure 3-11. iDDNS configuration

Note:

iDDNS is a free DDNS (Dynamic Domain Name Service) service offered by Compro. iDDNS service is not be available for use when C4Home service is enabled. If you are using floating IP address, you can use DDNS service to create a hostname that links to your home or office IP address. Having created the iDDNS address name, you can then enter `http://xxx (input by yourself).iddns.org' into your browser's address bar to remotely access your camera.



If your local LAN and router have firewall to block attack from outside, you have to configure the HTTP port on your router. For example, if you set the HTTP port "2001" for your IP camera, your IP camera's address will be *http://xxx (entered by you).iddns.org:2001*.

10. (Skip here if you didn't enable C4Home service.) You need to login to your C4Home account. If you don't have a C4Home account yet, choose to create a C4Home account and continue with account registration.



Figure 3-12. C4Home account setup

11. iWizard starts programming your camera based on your settings. Please wait patiently and DO NOT interrupt the process. (If you didn't enable C4Home service, you'll get to review your settings before saving them.)

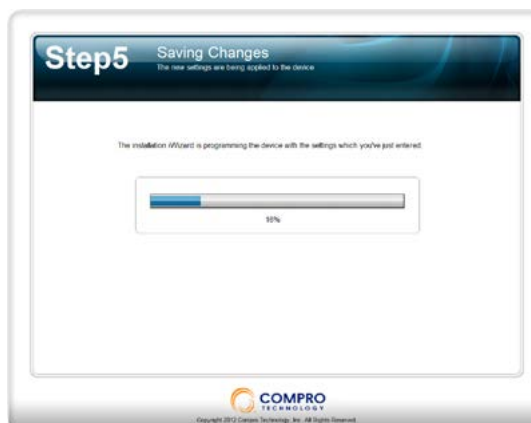

Figure 3-13. Saving Changes

12. The iWizard performs system diagnosis based on your network settings and alert you for inappropriate settings (marked with a question mark icon).



Figure 3-14. System Diagnostics

13. iWizard indicates the setup has completed successfully. You can click on the URL to view the live video now. Or click [Yes] if you wish you set up another camera from scratch.

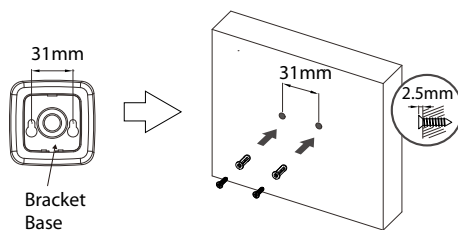

Figure 3-15. Multi-device Setup

Mount the Camera

If desired, you can mount the camera on a wall or ceiling. The following section explains how to mount your camera.

1. Drill 2 mounting holes on the mounting surface. While you are at it, bear in mind that there will have to be a minimum space of 2.5 mm (0.098 inch) between the screw head and the mounting surface. Also, the 2 mounting holes on the wall or ceiling should be spaced exactly 31 mm (1.22 inch) apart to correspond to the position of screw holes on the camera's bracket base. Then, if you're mounting on a concrete wall, insert a screw anchor into each of the mounting holes.



2. Loosen the fastening hex nut to detach the bracket from the camera.



3. Remove the base cover by inserting a flat blade screwdriver into the small hole on the bracket base and then pressing the screwdriver downward.

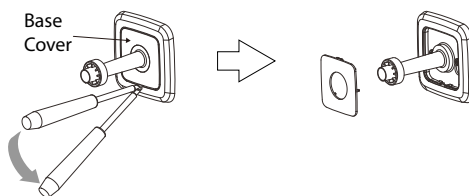

4. Put a screw into each of the mounting holes. Then secure the bracket to the mounting surface.

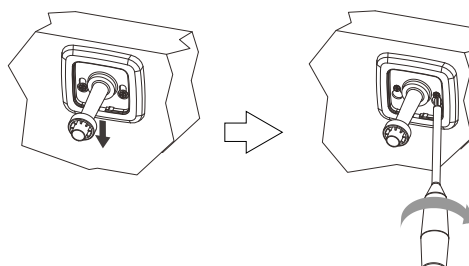

5. Finally, click the base cover back into position. After that, attach the camera body back to the bracket and then adjust the camera to the desired viewing angle.

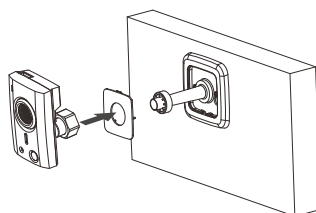

Chapter 4: Accessing the Camera

Ways of Viewing Live Video

There are a number of ways to view the live video feed from your Compro IP camera, which are as follows.

1. Use the C4Home™ service to access your IP camera. C4Home™ is a platform for viewing, managing and sharing camera feed over the Internet. Once the C4Home™ service has been successfully enabled, you can then use the C4Home™ camera viewer app, available on PC and smartphone, to view and manage all of your Compro cloud cameras. This is the easiest way to view the video of the network camera and no learning time required.
2. View the live video stream on the Internet Explorer (WebVUer), which comes with all Desktop/Laptop/Nettop/Tablet with Windows system. (Non-IE web browsers, such as FireFox and Safari, are also supported after a VLC plug-in installation.)
3. View the live video stream on the mobile web browser of your iPhone/iPod, Android phone, BlackBerry, PDA, MID or any other mobile phones with a built-in web browser. Through live Motion-JPEG video streaming, you can view your Compro IP camera while on the go. (On the camera end, the secondary video stream must be enabled; the Motion-JPEG mode only offers live viewing function.)
4. View the live video stream on a 3GPP-capable cellular phone over the internet. This is the preferred way of accessing your camera while you are away from home and have no access to a computer. However, due to some limitation of this technology, only video stream is provided in this mode. (On the camera end, the secondary video stream must be enabled.)



Note:

Your wireless carrier will be charging at a pre-determined rate for using mobile data service.

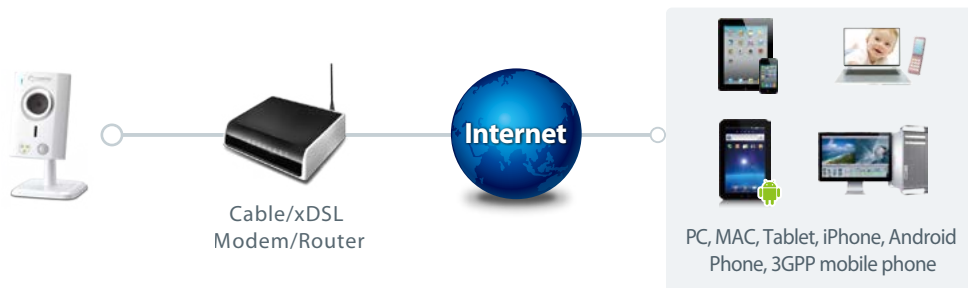

Figure 4-1. Ways of accessing camera

Instant Monitoring

From C4Home iPhone/Android App



When you enable and register the C4Home™ service, you can use the C4Home app on your iPhone, Android phone or tablet to manage and watch live video of Compro cloud network cameras.

The C4Home app is a safe and easy way to monitor your home, office and your valuable possessions from anywhere in the world. No router setup required, only needs to start your C4Home app and login with your account, you can watch live video of your network camera and manage multiple cameras from your smartphone or tablet on hand.

C4Home Login Page









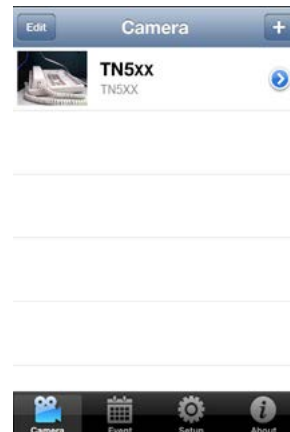

Start the C4Home app from your smartphone, you can login here with your own Account ID and Password. If you forgot your password, please click the "Forgot your password" button, the system will send the password to your register email account.

Icon	Name	Description
	Create account	Here you can create the new account, please input the new account ID, password and email account for account registration.
	Setup	Here you can input your account ID, password and server address (default server: www.c4home.com) for enable/disable auto-login. And you can choose the display language here.

Camera Page

After login the C4Home app, you will see the camera page, here shows the camera list, you can click to watch the live video or you can click the buttons below for more features.



Icon	Name	Description
	Edit	Click here to remove the installed network camera from list.
	Add Camera	Click here to add camera to the list. Please refer to the setup chapter for add the new cameras.
	Camera Setup	<p>Here you can setup more details for each camera:</p> <ul style="list-style-type: none"> • Camera Settings: Setup the camera name and password for camera management. • Stream Settings: Setup the Codec, Resolution, Frame rate for video streaming and Enable/Disable audio, Codec and Quality for audio streaming. • Notification Settings: Enable/Disable motion detection and select the sensitivity level for motion detection. • Sharing Settings: Enable/Disable the camera sharing to others. You can add your families or friends' account ID to share the live video monitoring.
	Camera Page	List all the available camera here and you can click to watch the live video.
	Event Page	<p>List all the happened events by time, includes the camera online/offline and motion detection. You can click the listed event to watch:</p> <ul style="list-style-type: none"> • Liveview: Watch the live video of network camera. • Playback: Playback the snapshots. When the event trigger, the camera will take 3 snapshots for record and you can know what's happened. • Save: Save the event and snapshots for record.
	Setup Page	<p>Click here for basic settings of C4Home app:</p> <ul style="list-style-type: none"> • Language: Select the display language for C4Home app. • Stream Buffer Size: Setup the stream buffer size for low, median or high. • Auto Login: Enable/Disable auto login for C4Home app. • Push Notification: Enable/Disable the push notification for your device. If you enable it, it will send you the push notification when event triggered. <div data-bbox="798 1344 1093 1422" style="text-align: center;">  <p>C4Home Motion Alert "TN5XX"</p> </div> <ul style="list-style-type: none"> • Logout: Logout the C4Home app.
	About Camera	Here will shows the version number of C4Home app and copyright information.

Live Monitoring

In camera page, you can click the camera on the list to watch live video for monitoring.

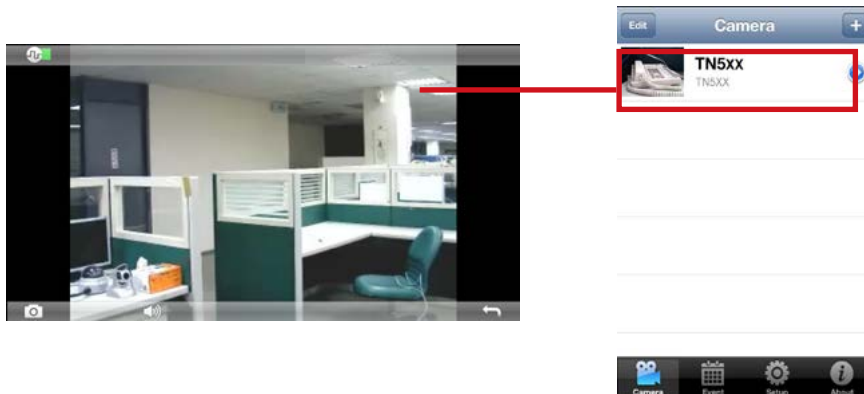

Network connection quality indicator:

In the live video screen, the network connection quality will show on the upper-left:

Green : The response time < 0.5 Sec.

Orange : The response time > 0.5 Sec. and < 1.0 Sec.

Red : The response time > 1.0 Sec.

On the bottom of live video screen, you can click the camera icon to take snapshot to your device, turn on/mute the audio from microphone of network camera, and back to the camera list.

2-Way Audio Communication from Smartphone

This feature allows you to use voice communication directly from your smartphone and the network camera's microphone/speaker.

While you are watching the live video on your smartphone, you can eavesdrop on the monitored area to know what's going on and you can broadcast your voice to intruders from your smartphone. Please touch the live video screen on your smartphone with finger, it will show the talk icon. Now you can speak to your smartphone and your voice will be broadcast from the speaker of network camera. You can use this feature to communicate with your family or to the intruders.

While you are talking to the smartphone, please keep touching the live video screen for communication.

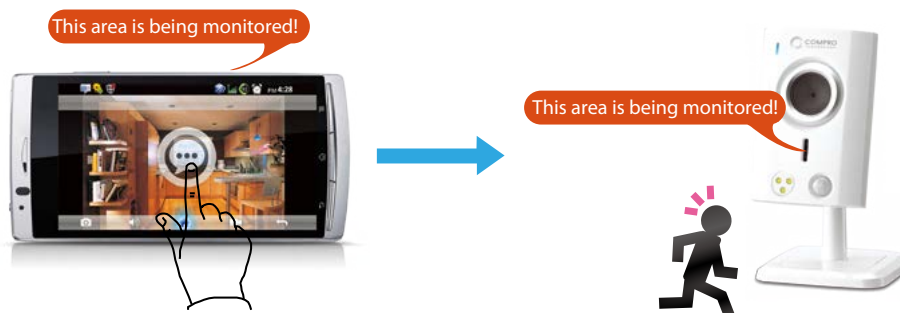

Figure 4-2. Smartphone 2-way audio

From Android Phone/Tablet App

The Android system C4Home app is almost the same features with iOS version, the Android version app also provide "Enable/Disable Vibrate" and "Refresh Media Store" in app setup page. And also, the Android version app support 4 camera monitoring at one screen as below.



Figure 4-3. C4Home app in Android phone

From C4Home Website

If you already enable the C4Home™ service in the installation procedure, you can open the Internet Explorer on your PC and login to the C4Home™ website (www.c4home.com), then you can manage your network cameras, watch live video and share video with your friends. When you login the C4Home™ website in the first time, the Internet Explorer will remind you to install the ActiveX components, please follow the instruction to install it. After installed the ActiveX, please add the www.c4home.com to your safe website list in Internet Explorer.

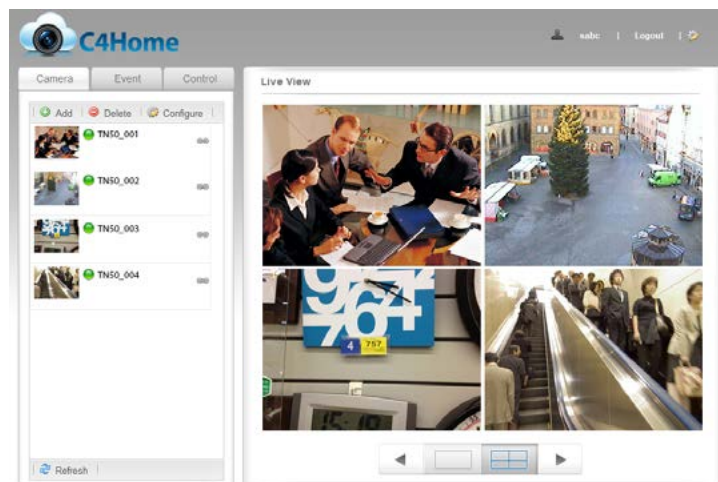

Figure 4-4. Viewing from C4Home Website



Caution:

The ActiveX components of C4Home™ website only support 32-bits Internet Explorer. If you are using the 64-bits operation system, please use the 32-bits Internet Explorer for viewing network cameras on your PC.

Accessing via PC Web Browser

User can check the current condition of the monitored area via Internet Explorer which comes with all Windows-based computer system. Please refer to the following steps to watch live view on WebVUer:

1. Open the Internet Explorer.
2. Enter the camera's IP address in the address bar. (e.g. 192.168.0.100). If you don't know the IP address of your camera, use Compro iWizard to scan for your camera on your LAN network.
3. A dialog box that requests the user name and password appears; enter a valid user name and password, and then press OK. The default user name and password are both 'admin.'



Figure 4-5. Login dialog box



Note:

If you forget your user name and password, you need to reset your camera back to factory default settings (see Troubleshooting chapter).

4. After valid user name and password are entered, Internet Explorer will prompt the installation of camera software from 'Compro technology, Inc.'
5. Click on the warning message and choose to install the ActiveX.

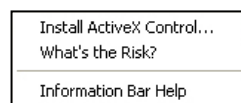

Figure 4-6. Installing Compro ActiveX

6. And then the reconfirmation dialog box will come up. Please press [Install] to install the 'ComproClientActiveX.cab' on your system.



Note:

Compro ActiveX components only support 32-bit Internet Explorer. Hence, if the viewing computer system is running 64-bit version of Windows, the 32-bit version of Internet Explorer must still be used to access the camera.

7. Meanwhile, the Windows Security Alert dialog box may appear. Please click [Unblock] to unblock it from firewall.



Figure 4-7. Unblocking application

8. Now you can start using WebVUER on Internet Explorer to watch live video and manage your network camera.

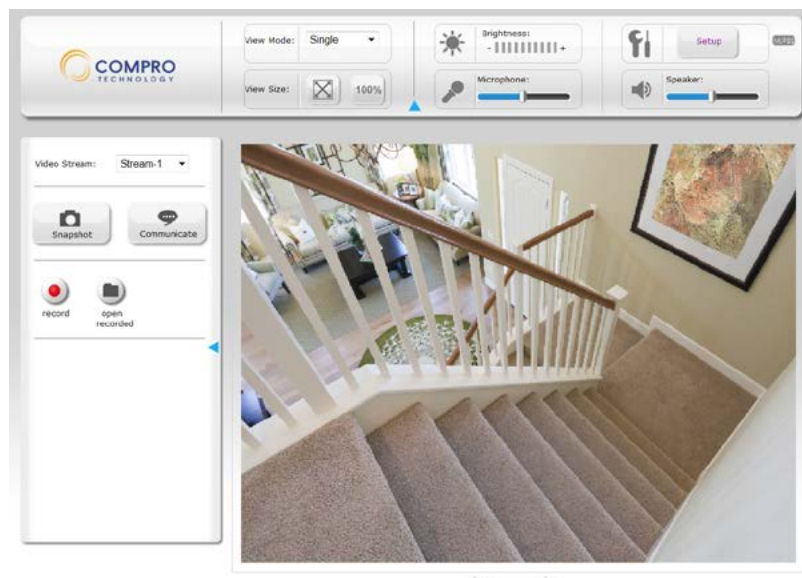

Figure 4-8. Live view



Note:

If your IP camera falls behind a firewall, you will need to enable ports 80 and 554 (default HTTP/RTSP port used by the camera) in your firewall and link them to the internal IP address of the camera. Should you have more than one IP cameras, please increase the value of the above port by 1, e.g. the second camera will have port 81 and 555. Please refer to the manual of your router or firewall.

Accessing via M-JPEG Mode

As long as your handset comes with a built-in web browser, you can use it to view the live video feed in M-JPEG format (video only). Viewing of M-JPEG video stream is supported on popular smartphones, such as iPhone or Android phone, as well as on a variety of mobile Internet devices such as Laptop, Tablet, PDA, Nettop, MID, etc. with built-in web browser.

Platforms and supported web browsers are as follows:

- Windows: IE, Google Chrome, Safari, FireFox (non-IE browsers require VLC plug-in)
- Linux: FireFox
- Mobile Device: iPhone, iPod Touch, BlackBerry, Android, WM and major-brand mobile phones.



However, before you can successfully view your camera video from a remote location over the Internet, first you need to configure port forwarding on the network router to which your IP camera is connected (see the remote viewing section in the Troubleshooting chapter). Afterwards, follow the steps below to enable the camera's secondary video stream for viewing on mobile devices.

1. Use a PC to log on to the camera, and go to [Setup] > [Video Settings], and check the [Enable 2nd Stream (include 3GPP)] box to enable the secondary video stream.
2. For the Stream-2, set the Codec as "Motion-JPEG."
3. Launch the web browser on your iPhone, Android phone, or any other mobile Internet devices, and enter "(IP-address)/mjpeg.html" into the address field of your phone's web browser to watch live video on your mobile device. You can also click on the link at the bottom of the Video Settings page to preview the M-JPEG stream on your PC.

Video settings

Turbo Picture (Offers best picture quality with max frame rate of 15 FPS)
 Motion Adaptive (Offers higher frame rate of up to 30 FPS with a max resolution of 640 x 480)

Enable 2nd Stream(include 3GPP)
 Please enable 3GPP stream to allow the live view on cell phones.

Please set Stream-2's codec to Motion-JPEG if you wish to view the live stream on cell phones with web browser only (without a RTSP client).

Stream 1:	Stream 2:
Resolution: SXGA	<input checked="" type="checkbox"/> 3GPP Mode
Codec: H.264	Resolution: QQVGA
Framerate: 15	Codec: MPEG-4
Quality: 1Mbps	Framerate: 5
	Quality: 512kbps

Viewing on PC : <http://compromk.IDCINS.org/>
 Viewing on 3GPP Phone : <rtsp://compromk.IDCINS.org/medias2>
 You may wish to bookmark the above links in your browser for future reference.

Figure 4-9. Enable 2nd stream

Accessing via 3GPP Mobile Phone

You can access your IP camera via 3GPP-compatible mobile phones provided that the IP camera has a stable Internet connection and the mobile device has a good connection to GPRS or to 3G network. There are several prerequisites that need to be met before using the 3GPP function successfully.

1. User should turn on the 2nd stream of the IP camera and set the resolution as QQVGA, FPS as 5, codec as MPEG-4 and select a medium bit rate for Quality. In addition, after enabling the 2nd stream, you will notice a drop in the frame rate for the primary stream. This is a normal behavior since the camera system has to process two streams instead of just one.
2. User needs to enable DDNS function and obtain a valid Dynamic DNS (DDNS) address as detailed in earlier sections of this manual.
3. Ensure that an active internet connection is available for both the IP camera and the intended mobile phone.
4. Port forwarding on the network router to which your IP camera is connected must be configured properly in order to enable remote viewing on your IP camera.

Having taken above actions, enter the camera's RTSP streaming address into the address field of your mobile web browser or streaming software in order to view the live image. For example, enter "rtsp://ipcamera-ip/medias2" (the "ipcamera-ip" is the DDNS address that you've obtained in the installation process).

**Note:**

Compro does not guarantee the successful viewing of live video on every 3GPP-compatible cell phone. You may also need to consult with the mobile network service provider about the usage and availability of 3GPP format.

Chapter 5: Live View (With WebVUer on PC)

Page Layout

On the first page, you can see the basic control panel at the top and on the left-hand side, and the live video on the right-hand side. Click on the ▲ icon to hide or show the control panels.

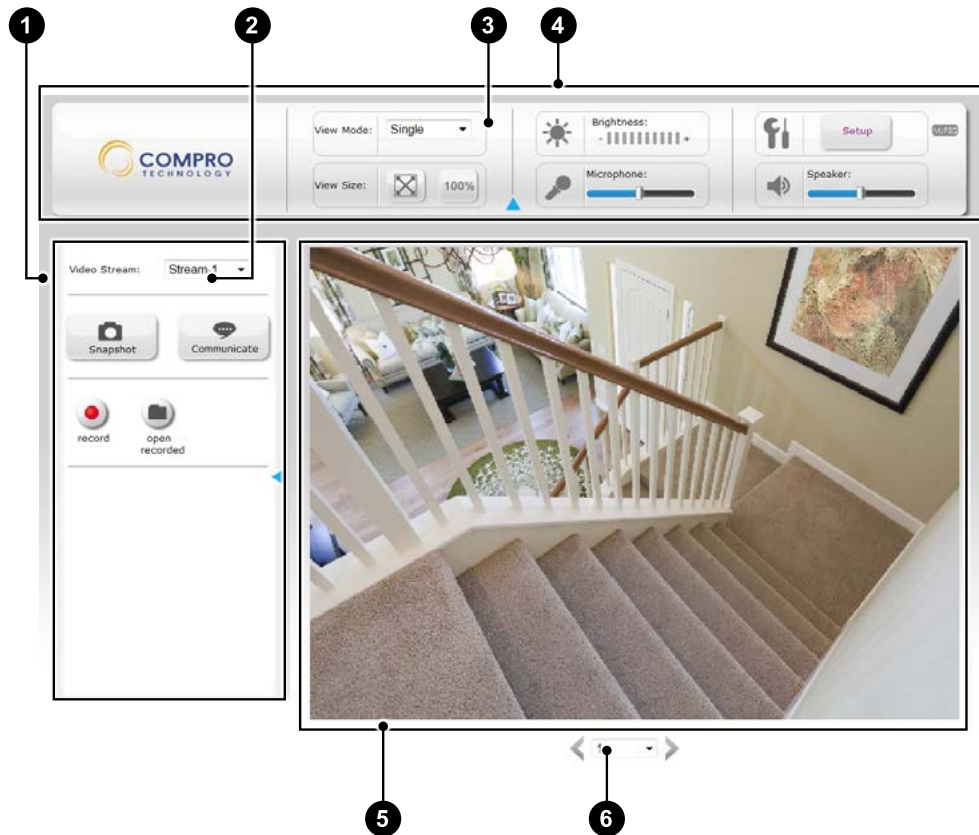







Figure 5-1. Layout of LiveView page

- ❶ **Left control panel** – Here provides control over video recording, voice communication, and snapshot.
- ❷ **Video stream selection** – You can switch between Stream-1 and Stream-2. (Stream-2 can be enabled and configured in video settings.)
- ❸ **Video mode selection** – Let you switch video display between single, multi, and auto scan mode.
- ❹ **Top control panel** – Let you adjust camera video and microphone and speaker volume.
- ❺ **Live video pane** – Live video stream. You can switch to full-screen mode by right-clicking on the video pane and select "Fullscreen".
- ❻ **Channel selection** – Select a channel from the drop-down list, or click on the arrow icon to switch to next/previous channel. Up to 16 cameras can be added to your channel list, and using the "Multiple" video mode allows you to monitor 4 channels at the same time.

Icons on Live View Page





Top Panel

Icons seen on the top control panel:

Icon	Name	Description
	Fit Browser	One of the view size button; the Fit Browser button resizes the live video pane to fit browser window size.
	Actual Size	One of the view size button; the Actual Size button resizes the live video pane to original size.
	Brightness	Adjusts the Brightness of camera image as you wish. Anonymous users will need to provide user name and password of administrator level to adjust brightness setting.
	Microphone Volume	Use its slider to adjust the Microphone Volume . Click on this icon to mute the built-in microphone.
	Setup	Click on the [Setup] button to access the main setup page of your camera.
	Speaker Volume	Use its slider to adjust the Speaker Volume . Click on this icon to mute the built-in speaker.



Left Panel

Icons seen on the left control panel:

Icon	Name	Description
	Snapshot	Click the Snapshot button to take a snapshot from live view. A preview window will pop up upon hitting this button (the size of the preview image is forced as 320 by 240 pixels). Right-click on the preview image and choose 'Save Image As' to save the snapshot to your PC (the resolution of the saved snapshot depends on the video resolution you configured in the 'video settings' page).
	Communicate	This Communicate button allows you to speak into your PC microphone and broadcast through camera's speaker. See "Voice Communication" section for details.
	Record	Record live video by pressing the [Record] button. (If your computer can not play .mkv file format, please download and install VLC media player or KMPlayer from the Internet.)
	Open	Open a file browser to search and play back video files captured by the camera. (File format is .mkv)

Others

Other icons seen on this page:

Icon	Name	Description
	Digital Zoom	Digital Zoom button. Available zoom factor: 1~10x.
	Switch Channel	Click on the left/right arrow to Switch Channel .

Enable Digital Zoom

To enable the digital zoom feature:

1. Click on the magnifier icon located on the lower-left corner of real-time video display, and then the digital zoom control window will pop up.
2. Check [Enable Digital Zoom] option and set desired zoom ratio by dragging the adjustment bar. Then set the area to be enlarged by dragging the black square shown on preview window. Click on the [X] button shown above or press [Esc] key to save the changes and/or close the preview window

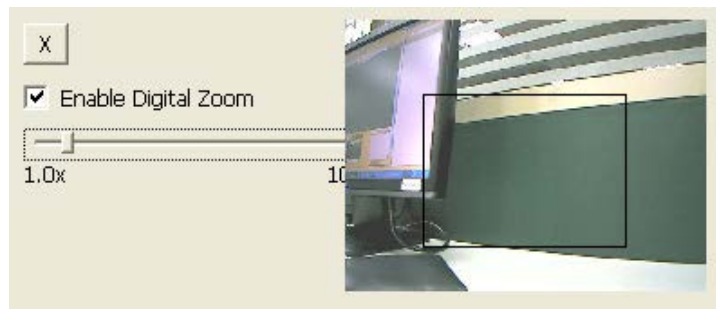



Figure 5-2. Digital zoom window

Voice Communication

Pressing the [Communicate]  button allows you to speak into your PC microphone and broadcast through the camera's speaker or audio line out. To talk through the external speaker connected to the IP camera, place your cursor on the [Communicate] button (the tool tip "Right click to setup" will appear), and right-click on the button and select [Setting] to choose input device and input source.

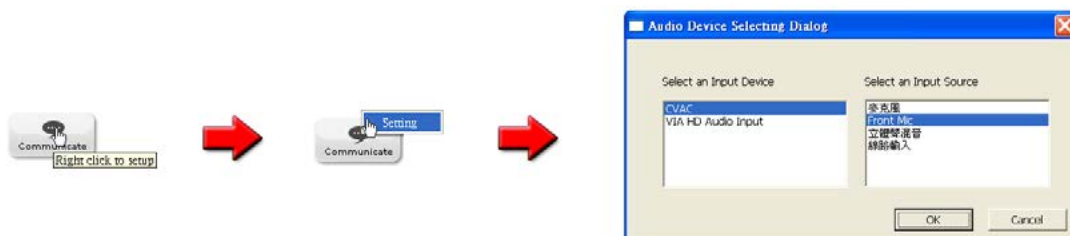

Figure 5-3. Communication setting

Having configured the device, please hit the [Communicate] button, (which then shall remain in "pressed" status for 90 seconds and automatically be released later, unless it is hit again) and talk through the microphone.



Note:

When using the voice communication feature, you may experience various degrees of delay between transmission from the computer and playback on the camera end depending on the condition of your network environment.

Chapter 6: Configuration (From WebVUer)

Main Setup Page

The main setup screen consists of all the basic settings options. To access the main setup page, click on the Setup button  seen at the top-right location in the live view screen. Then the setup page as shown in the picture below will be displayed. You can configure the detailed settings of your IP camera here.

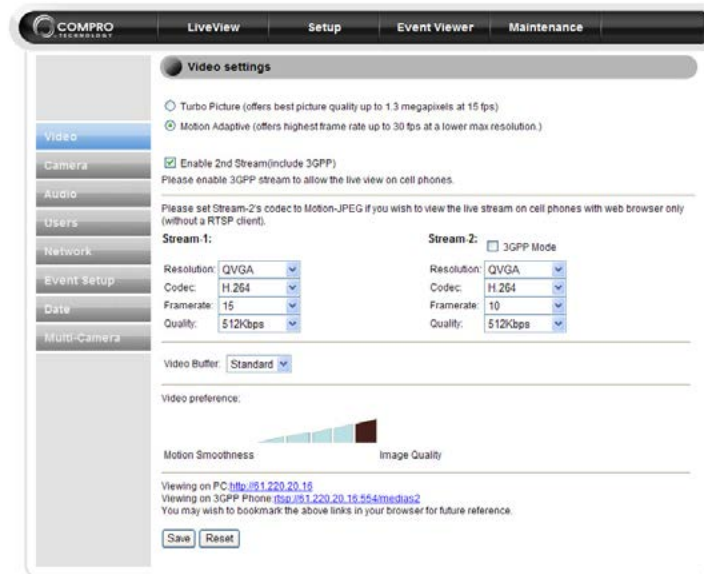

Figure 6-1. Main setup page

You also can go back to live view screen by choosing LiveView from the top menu. The top menu also allows you to go to the Event Viewer and Maintenance of the camera. The main setup menu on the left contains several parts.

Video Settings

Here you can configure the settings for video stream.

Figure 6-2. Video Settings

Video Mode

You can select between Turbo Picture and Motion Adaptive mode.

- **Turbo Picture** - This mode will provide you with the best video quality, but max. frame rate will be limited to 15.
- **Motion Adaptive** - This mode will provide up to 30 FPS at a lower maximum resolution.

Stream Setting

You can change the setting of resolution, codec, frame rate, and quality for the video stream. If you need to watch the live video on your mobile phone or PDA, please check the [Enable 2nd stream (include 3GPP)] checkbox to enable the secondary video stream, and then the stream setting for the 2nd stream will be displayed.

Video Buffer

Here it allows you to adjust the video buffer size. If you experience occasional network congestion during live viewing, using a small or large buffer setting, instead of the standard setting, may improve video smoothness. But the larger the buffer size is, the higher the video latency will be.

Video Preference

Click on the bar to set your video preference (to stress motion smoothness or image quality). The video preference bar adjusts the interval between each "I-frame" in the compressed MPEG-4/H.264 video stream. In a sequence of images, there are inserted I-frames that can show the complete representation of the picture one sees at a particular moment. Between I-frames are what are called P-frames (which can be decompressed using the data from preceding frames) and B-frames (which utilizes the data from the preceding and

following frames for achieving higher compression ratio). In essence, the shorter the interval between the I-frames is, the higher the video quality will be (motion in video will also be smoother). However, shorter I-frame interval will raise the bandwidth consumption of the video stream and lead to larger file size of the recorded clips.

Camera Settings

Here you can control the image color and related settings as well. All the changes you have made with regard to video properties will be reflected in the preview window after you click [Save].

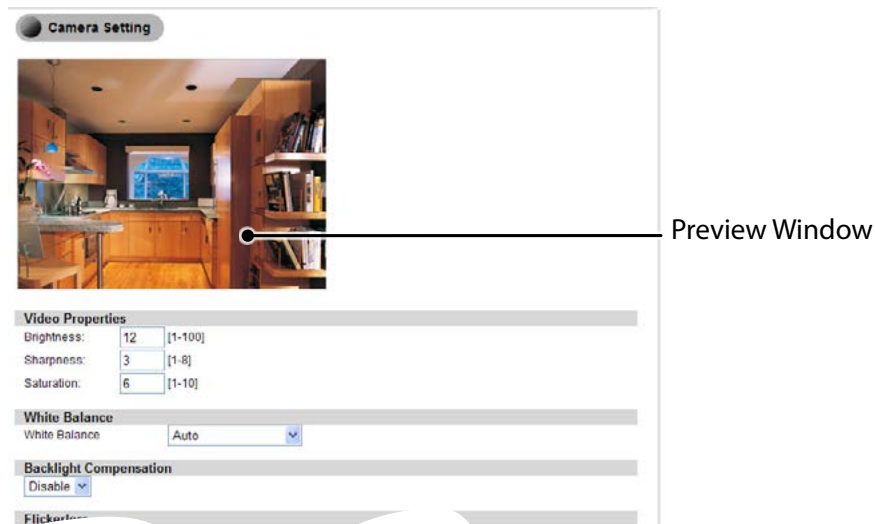

Figure 6-3. Camera setting page

Video Properties

Here you can adjust the Brightness, Sharpness, Contrast and Saturation on your IP camera.

Backlight Compensation

This lets you turn on or turn off backlight compensation and select the strength of the backlight compensation, which when enabled can make the subject appear clearer in the image when the backlight is too bright or the subject is too dark. (Default: Disabled)

Flickerless

Here controls the flickerless mode: 60 (default) or 50 Hz.

Low Light Behavior

Switching on the Low Light Behavior will produce better and clearer image when the camera detects low environment lighting. When the Exposure Control is set as [manual], the Low Light Behavior control will be dimmed and inaccessible. Here the default setting is [Off], and the shutter speed and gain level will be set as 1/30s and 7.5 by default on the condition that low environment lighting is detected. Switching on the low light behavior allows you to manually set the shutter speed and gain level in the case of low environment lighting. There are two adjustable parameters for low light behavior.

- **Maximum Exposure** - Adjust the shutter speed by selecting between "Disable" and "30 fps". Lower frame rate means longer exposure time, which allows more light to be captured by the image sensor. However if there is fast motion in the scene, increased exposure time will result in motion blurs in the captured image. Choosing [Disable] will use the default value of max. exposure and max. gain in low-light setting, which are 30 fps and 7.5 respectively.

- **Maximum Gain** - This allows you to adjust the gain level between 1 and 8.5 dB. Higher gain level increases the brightness of the picture but also increases the noise in the picture.

LED Indicator

This lets you control the LED indicator at the front of camera. Turn on the LED indicator, or turn it off in case you don't want people to notice the camera is working.

IR Light Control

The TN60 network camera is equipped with 3 IR LEDs, which makes it capable of fitting different lighting situations and providing 24/7 monitoring.

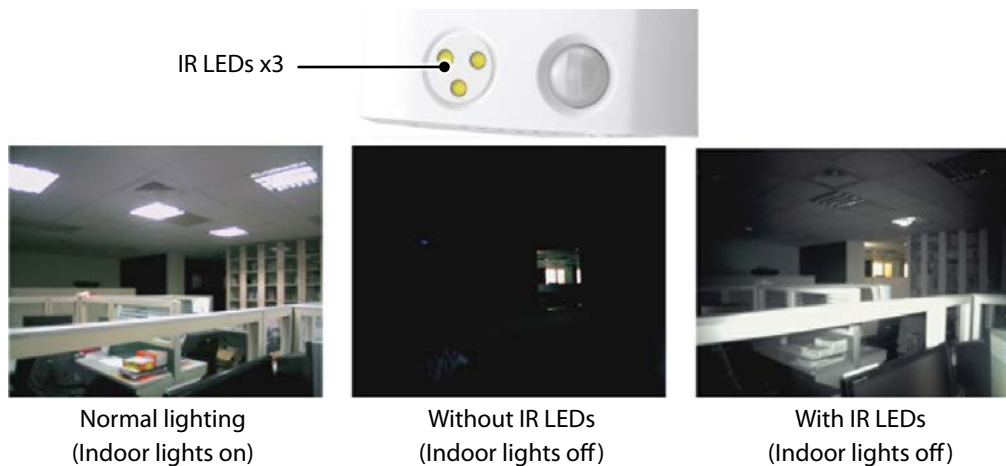

Figure 6-4. Effect of IR LEDs

You can configure the IR light operation mode to be [Auto], [Always On], [Always Off], or [By Schedule].

IR Light Control

Operation Mode Auto ▼

Activate IR Light on : Deactivate IR Light on :

always
 only during time frame

Sun Mon Tue Wed Thu Fri Sat

Figure 6-5. IR light control

For scheduling on/off time of the IR LEDs, you can directly input the desired On and Off time, and set the repeat option to be [always] or [only during time frame].

Embed Text and Image

You can embed text and/or image at 4 different locations on the live screen. (Upper Left, Upper Right, Lower Left, Lower Right). To embed an image, click on the Upload Image text link and choose a suitable image (limited to JPEG/BMP, 100x30 pixels, 128KB.) To remove an embedded image, press the [Clear] button.

Flip Mode

Enabling this option will flip the image vertically, making the image appear rotated 180 degrees. Enable this setting when you need to reposition your camera from standard position to ceiling mounting position.

Audio Settings

Here you can choose to enable or disable the audio and also adjust the volume. The Stream-2 audio is only available for adjustment when you turn on the 2nd Stream and check its 3GPP mode option under video settings.

Figure 6-6. Audio settings page

User Settings

Here you can add, modify or remove viewers/administrators. The viewers are only allowed to view live video and can't change any of the camera settings. On the flip side, the administrators have the rights to make any changes.

Figure 6-7. Users Setting

- **Modify/Remove** - Click here to Modify or Remove an existing viewer.
- **Add** - Click here to add a new viewer or administrator
- **Allow anonymous viewer login** - Click here to allow anonymous viewer login without requiring user name and password, but only to allow them to view the live video.

When you add a new user, you need to provide the information on user name, password and group type.



Figure 6-8. Adding/Modifying user

Network Settings

Here you can check your network settings and adjust the detailed settings.

Ethernet

Choose the IP address configuration. The camera can obtain IP address via DHCP (recommended), use the manually inputted static IP address, or obtain IP address via PPPoE for which you need to provide valid user name and password.

Wireless

If you have installed the Compro wireless adapter on your IP camera, you can set up the wireless connection in this page. To connect wirelessly, please check the [Use Wireless First] box to give priority to wireless connection when LAN network is also connected. And then provide the necessary information on IP address (to obtain IP address via DHCP or use specified static IP address) and access point. And click [Save] to save the changes.

Wireless Settings

Wireless
 Use Wireless First

Obtain IP address via DHCP
 Use the following static IP address:
 IP address:
 Subnet mask:
 Gateway:

Access Point

ESSID	Signal level	Channel	Encryption key
Tech_4	100 dBm	Channel-2.41	on
dlink_shuling	52 dBm	Channel-2.41	on
WBR-5003	46 dBm	Channel-2.41	off
Buffalo test	42 dBm	Channel-2.41	on
TP LINK	76 dBm	Channel-2.42	on
Tech_3	44 dBm	Channel-2.43	on
Tech_2	46 dBm	Channel-2.43	on
Ren Buffalo	53 dBm	Channel-2.43	off
_SOTERIA	46 dBm	Channel-2.41	on

Settings
 SSID: ▼
 Keyphrase:

Figure 6-9. Wireless settings

Network Diagnostic

Here you can run the diagnostic tool for your current network settings and it will show error messages if any anomaly is detected. For further information on error messages, please refer to the FAQ section in this manual or visit www.comprosecurity.com for more information.

Network Bandwidth

This automatic network connection speed test is to help users better define appropriate video bit rate for their applications. To perform network bandwidth test:

1. Go to [Setup] > [Network], and click on [Network Bandwidth] located on the left menu to start.
2. Wait for Internet Explorer to prompt for the installation of Java plug-in. Then click on the text to accept.

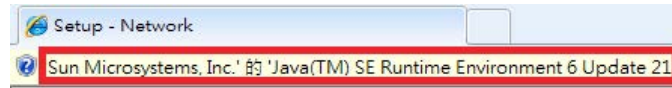

3. Camera begins testing connection speed.

Please wait while the camera is determining the connection speed.

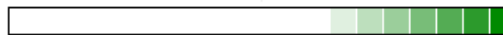

4. Once speed diagnostics is done, camera will advise on current network connection speed. See below example:



The camera's current connection speed can provide a smooth viewing of the video and you may open:10x simultaneous viewing of the 1st stream.

The message indicates that currently connected network has the network capacity to support up to 10 network cameras of identical bit rate settings (either on Stream 1 or Stream 2). If the message shows a less favorable result, go to [Setup] > [Video] to select a lower current video bit rate setting

Advanced

Adjust the advanced network settings here.

DNS server

Set the DNS server address to be via DHCP or choose to use user-specified DNS address.

NTP Configuration

Set the NTP (Network Time Protocol) server address to ensure the clock of the camera system is synchronized to show accurate time. To synchronize camera clock via NTP server, choose either to obtain NTP server address via DHCP server whose address needs to be provided manually, or to use an external/public NTP server whose default address is set as pool.ntp.org.

HTTP server

Set the HTTP port for your IP camera to be viewed and controlled from the internet. The default port is 80. Valid port numbers are between 1 and 32767. If you need to use port forwarding, please refer to the Port Forwarding section in this manual.

RTSP server

Set the RTSP (Real-Time Streaming Protocol) port for your IP camera to enable the support of 3GPP streaming for mobile phones. Default: 554. If you need to use port forwarding, please refer to the troubleshooting section for port forwarding setup.

DDNS

Click here to enable the DDNS (Dynamic Domain Name Service) service if you are using floating/dynamic IP and want to tie your camera's current IP address to a domain name. And instead of remembering a string of IP address, you can use the easier-to-remember domain name to access your camera over the Internet. Compro iDDNS service is recommended here for use. If you already have an account with DynDNS or no-ip, you can also input its domain name here for easier access to your IP camera.



Note:

1. Compro's iDDNS server will automatically delete addresses that haven't been updated for more than 3 months.
2. If you already enable the C4Home™ service, you don't need to apply the iDDNS service for your camera.

UPnP

Check here to enable/disable the UPnP function on your IP camera installed on your local network. Also, you can change the device name here. If your operating system supports Universal Plug and Play (UPnP™) and DHCP is in use on current network, this Compro IP camera will be automatically detected and added to My Network Places on your Windows. If you want to use the IGD (Internet Gateway Device) protocol on your IP camera, please check the [Enable IGD] box to enable it.



Note:

If you want to enable the UPnP™ service on your Windows, please execute the "Add or Remove Programs" item found in "Control Panel", and after "Add or Remove Programs" window appears, click on "Add/Remove Windows Components" and then double-click on "Networking Services" item and check "UPnP User Interface" box and proceed to install the component.

RTP

If you want to broadcast video using RTP (Real-time Transport Protocol), you can set up the port range, video/audio address and port number here.

QoS

QoS (Quality of Service) helps prioritize network traffic and reserve necessary bandwidth resource for critical applications. Here you can customize the packet priority for different types of packet data (video/audio stream, event/alarm, web page) by specifying a different value for the DSCP (Differentiated Services Code Point) field in their IP packets. The DSCP value that represents the top priority is 46. The default DSCP value is 0, which indicates normal priority (meaning not using QoS).

The following is a table of the recommended DSCP values. The drop precedence indicates the order in which IP packets shall be dropped when the network is congested. Packets of higher drop precedence will be dropped first. Each class in the table is assigned a certain amount of network bandwidth.

Drop Precedence	Class1	Class2	Class3	Class4
High drop precedence (3)	10	18	26	34

Drop Precedence	Class1	Class2	Class3	Class4
Medium drop precedence (2)	12	20	28	36
Low drop precedence (1)	14	22	30	38

Table 6-1. Recommended DSCP values



Important:

For the QoS function to work as it should, all the switches/routers in your network environment must also support and enable QoS.

Event Setup

When an event happens, a snapshot can be instantly sent to your E-mail account, ftp server, image server, or SMS server to warn you about what's happened.

In order to properly set up the event function, you must:

1. First set up the event server based on your needs: E-mail, FTP, or Image server.
2. Once the event servers are configured, you can then go to the trigger setup page to create an event trigger and the event action(s) in response.
3. In the motion detection page, click and drag on the preview image to create a detection region and then click [Save].

Event Server Setup

Here it provides the configurations of various event servers available on the camera. Please click on the event server you want to configure and provide necessary information.

Email server

Email server supports standard SMTP on SSL-protected webmail platforms such as Hotmail (Windows Live) and Google Mail (Gmail). To use this function, go to [Event Server Setup] > [Email Event Server Setup], and enter the SMTP server address and port respectively. Then enter your user name and password, and the E-mail subject as you like. As of August 2010, SMTP and SSL settings for Hotmail and Gmail are as follows:

Platform	SMTP Server	Port (for SSL)
Hotmail	smtp.live.com	587
Google Mail	smtp.gmail.com	465

Table 6-2. Webmail setting

For [Authentication Method], select [Login]. Enter a complete email address into sender/receiver field: xxx@xxx.com. Other SSL webmail platforms have not been tested.

FTP server

Here it provides the settings of the FTP server that can be used to store event snapshots taken by the camera when an event is triggered. To start saving snapshots to a FTP server, click on the text link to set up the FTP server. Ensure that you have put in correct server information before saving the changes. You may try using the default FTP port number, 21, if you don't know the server's port number. After that, set up the image server and then go ahead to create an event trigger and choose "FTP" as one of the event actions. (Depending on your network environment, it may take a certain amount of time to upload snapshots to the FTP server.)

Figure 6-10. FTP server setup example

Image server

This page allows you define the naming rules of the snapshots taken by the camera and saved to the server when an event is triggered.

Figure 6-11. Image server setup example

SMS server

Here it provides the configuration for SMS notification feature that allows the camera to send a SMS (Short Message Service) alert message to one or more pre-defined recipients when a pre-defined event scenario is being triggered. This feature does not require additional hardware GPRS modem and SIM card installed. Users only need to first apply an account with a third-party, web-based SMS gateway service provider. To properly configure SMS server:

1. Under [Setup] > [Event Setup] > [Event Server Setup], click on [SMS server] to start configuration.
2. Provide the required data for the following field:

Field	Description
Service provider	Default: Clickatell
User name	User name registered at Clickatell
API ID	API ID provided by Clickatell
Target country	The country code for recipient's mobile phone number
Target cell phone	Recipient's mobile phone number. Enter only one recipient number in each field.

Table 6-3. SMS server setting

If you do not have a Clickatell account yet, please visit [www.clickatell.com], and click [SIGN UP]. Then

go ahead to sign up to the "Clickatell Central (API)" service and follow Clickatell's online instructions to obtain an API ID.

3. Choose [Next] to save the setting.
4. Customize the SMS message content if wanted. Choose [Next].
5. To receive a test message, click on [Send me a SMS message to the SMS Gateway]. Or choose [Finish] to save the configuration.
6. To enable SMS notification, go to [Setup] > [Event Setup], and click on [Trigger Setup] to create a new event trigger or modify an existing one. Then under [Event Actions], check [Send SMS] and choose [Finish]. Note that you must have enough credit at Clickatell in order to send SMS message.

Send SMS (please ensure you have enough credit in the Clickatell system)

Trigger Setup

You can create, modify, or delete event triggers and set the trigger mechanism to be by Schedule, Motion Detection, etc. When creating an event trigger by schedule, you can set up scheduled time and period. When setting event trigger as by Motion Detection, you can select the trigger area defined in the Motion Detection setting. After finishing event trigger setup, click [Next] to select event actions so your camera will take snapshots, send e-mails, or upload images to your FTP server.

Motion Detection Setup

Motion detection feature provides a selection of 3 regions for motion detection. You can directly click and drag on the preview screen to set a detection region. Prior to that, please select the region (0, 1 or 2) and the sensitivity level (S1: Lowest, S2: Low, S3: Medium, S4: High, S5: Highest) from their drop down list. Press [Save] button for the settings to take effect. If you like to remove an existing region, please select the region number and click [Delete] to delete it.

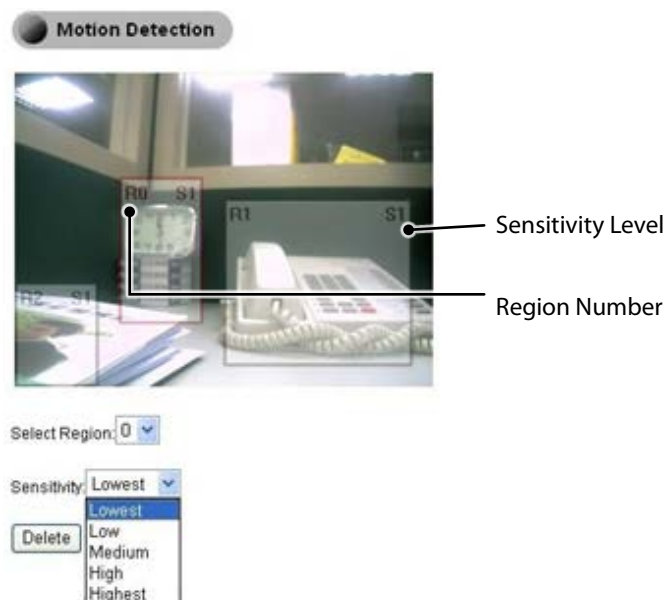

Figure 6-12. Motion detection

Date Setup

Here it displays the current time information stored in your IP camera, and you can set up the Time Zone for your current region or country, obtain time information from NTP server, and synchronize the clock of your camera system with that of your PC, or manually adjust system clock.

Multi-Camera

Here you can add, modify, or delete additional IP cameras on your camera list, and later switch between camera channels listed here on the LiveView screen. When you add a new IP camera, you need to input the required information into the IP address, username, and password field (port numbers may be required if they have been different). After pressing the [Save] button, you will see the status of the cameras on the list. To modify an existing camera, simply choose a camera from the list and click [Modify].



Camera Settings

Camera: 05 ▼

IP Address:

User Name:

Password:

RTSP Port: (Default 554) 554

HTTP Port: (Default 80) 80

Figure 6-13. Multi-Camera setting

OSD Setting

Here you can enable/disable the On-Screen Display on the video display. It's easier to know when the event happened. You can select the OSD font, font size, font color, background color, OSD position on video Stream-1 or Stream-2, and type in the text you want to shown on the video display.

Chapter 7: Event Viewer

Here it displays the history of past events successfully triggered by motion, or schedule (the available types of event trigger depend on camera support). Click on any type of event trigger to view its history.

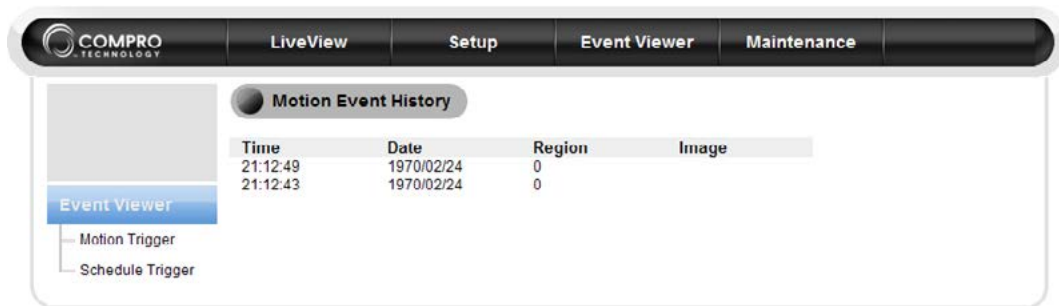

Figure 7-1. Event Viewer

Chapter 8: Maintenance

Here it provides the current information about your IP camera and the access to history log as well as system maintenance functions.

Information

Here you can check the firmware version as well as various settings of your IP camera .

Log

Here you can check the system log of your network camera. Press [Clear Log] to clean up system log.

Maintenance

You can reboot your IP camera, change UI language, export/import user profile, reset to factory default settings, or update camera firmware (after you download the latest firmware from Compro's website).

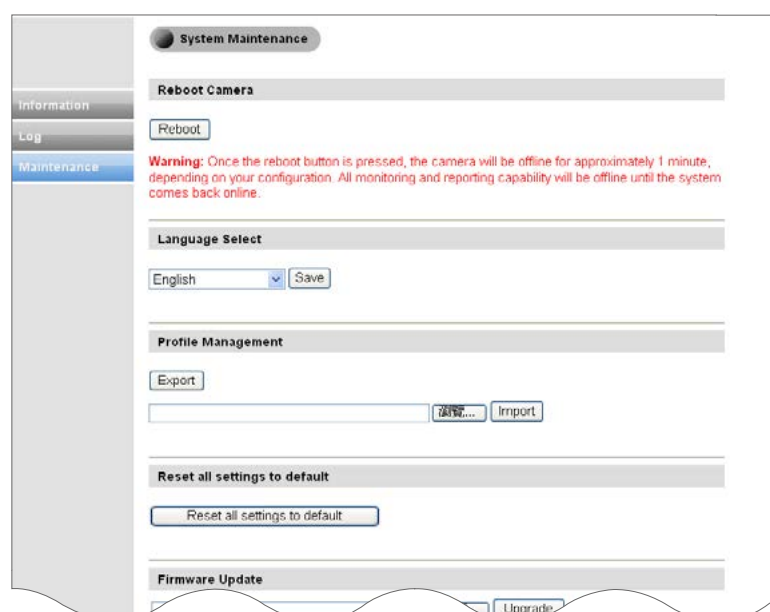

Figure 8-1. Maintenance page

Reboot Camera

Press the [Reboot] button to reboot your camera system. You can also opt for power cycling your camera in case you find your camera has been acting weird.

Profile Management

The profile management feature allows installers and users to set up a group of cameras with similar configurations at great ease. After the current camera is properly configured, users can export current camera's configuration to a profile on PC and then load it into other cameras, thereby making least changes possible like changes on IP address or a few other settings that might need to be modified individually when installing a surveillance system. In addition, this feature can also be considered as a backup mechanism for future service need. For instance:

1. After the current camera is properly configured, go to [Maintenance] > [Profile Management], and click on [Export] to download camera profile to a user-specified location.
2. To load an existing profile into a different camera, log in to the maintenance page of a different camera, press [Browse...] and locate the profile you wish to load, and then click on [Import] to proceed.
3. Camera will start to reboot, which will take approximately 60 seconds to complete. Do not interrupt

browser action during the process as doing so may cause problems to your camera system.

Reboot...

Reload page after 44 seconds.



Caution!

You may only cross-import profile among identical camera models.

Reset All Settings to Default

This will reset IP camera to its factory default settings, producing the same result as pressing the hardware reset button at the back of camera. If you need to perform hardware reset, refer to the Troubleshooting chapter.

Firmware Update

You can download the latest firmware from Compro's website (www.comprosecurity.com/en/supports.html). After downloading the firmware, please log in to the setup page of your IP camera and click [Maintenance] on the top menu and then look for firmware update section. Press the [Browse] button and locate the downloaded firmware file and press [Upgrade] button to update camera firmware. Once the update process begins, it must not be interrupted.

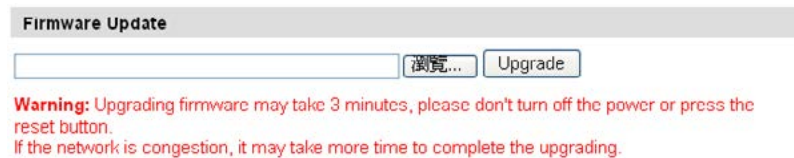

Figure 8-2. Firmware update

If you log in to the live view page after camera is rebooted and find that some icons are in the wrong place, try pressing [Ctrl] + [F5] to force a cache refresh of your browser.



Caution!

Before updating firmware, please close all other browser windows and background applications that are consuming network bandwidth.



Note:

Should you inadvertently close the browser window during firmware upgrade, DO NOT unplug the power cable or reset the camera immediately. Instead, try waiting for 3-5 minutes to see if the camera can complete the upgrade process, as the new firmware might have been successfully uploaded to the camera system and is still in the process of being written into the flash memory.

Chapter 9: Troubleshooting

During the course of installation, you might encounter various issues in regard to the usage of the camera. The following section contains some troubleshooting procedures to help you solve the problems.

Reset to Factory Default Settings

If you forget your system password or if you feel your IP camera has been acting weird, you can follow the steps below to reset the camera to its default state in which it will be using the Ethernet port for network connection and obtaining IP address from the available local DHCP server. To reset the camera:

1. Press and hold the reset button (located at the rear panel) for about 10 seconds; when successful, you shall see the Status Indicator go off.
2. After about 20 more seconds, the Status Indicator comes on again. It means that the IP camera has been successfully reset and restored to the factory default settings.
3. The camera will take 1 minute to reboot after it is reset successfully. Please wait patiently.
4. Start the iWizard again to scan for and re-configure the camera.

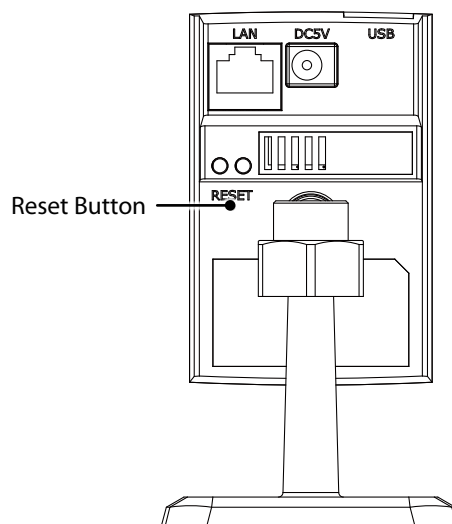

Figure 9-1. Reset button

Trouble with the ActiveX Client

When you launch the Internet Explorer and enter the camera's IP address in the address field, you'll be asked for the user name and password combination (the default is admin/admin, case sensitive). After that, you will be prompted to install Compro ActiveX components required for accessing the camera.



Note:

Compro ActiveX components only support 32-bit Internet Explorer. Hence, if the viewing computer system is running 64-bit version of Windows, the 32-bit version of Internet Explorer must still be used to access the camera.

No user interface in the browser:

This could be related to three possible causes.

1. ActiveX was not installed: Please install the ActiveX component by following on-screen instructions. This component must be installed. Otherwise you will not have access to the user interface.



Figure 9-2. ActiveX warning



Figure 9-3. ActiveX installation

2. ActiveX was installed but not enabled: Ensure that the ActiveX had been correctly registered with your Internet Explorer. Please open Internet Explorer and check that you've got both the "ComproClientActivex" control component registered and enabled under Tools -> Manage Add-ons.

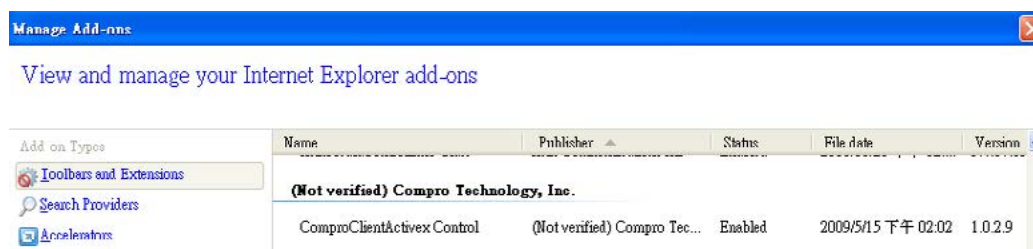

Figure 9-4. Add-on management

- Inappropriate browser security setting: Please ensure that your security setting in Internet Explorer allows the installation of ActiveX component by adding the IP address of the camera to the list of trusted sites in Internet Explorer.

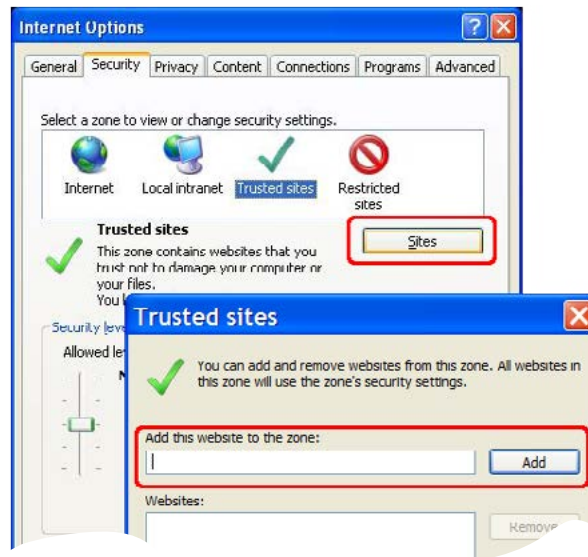

Figure 9-5. Browser security setting

If you've gone through all of the above steps but are still unable to obtain video/audio on the browser, please close all the browser windows and delete the "Compro Embedded" folder found under "(OS Drive):\Program Files". (If you're using 64-bit windows, look for "(OS Drive):\Program Files (x86)".) And then open your web browser and log in to the IP camera again to reinstall the ActiveX client. Finally, if you encountered the error where the browser returns "213 file not found", please restart your computer, which should help in this situation.

Trouble with Remote Viewing on Browser

You can view your camera video remotely over the Internet. If you have problem in remote viewing, refer to the section below for preliminary troubleshooting.

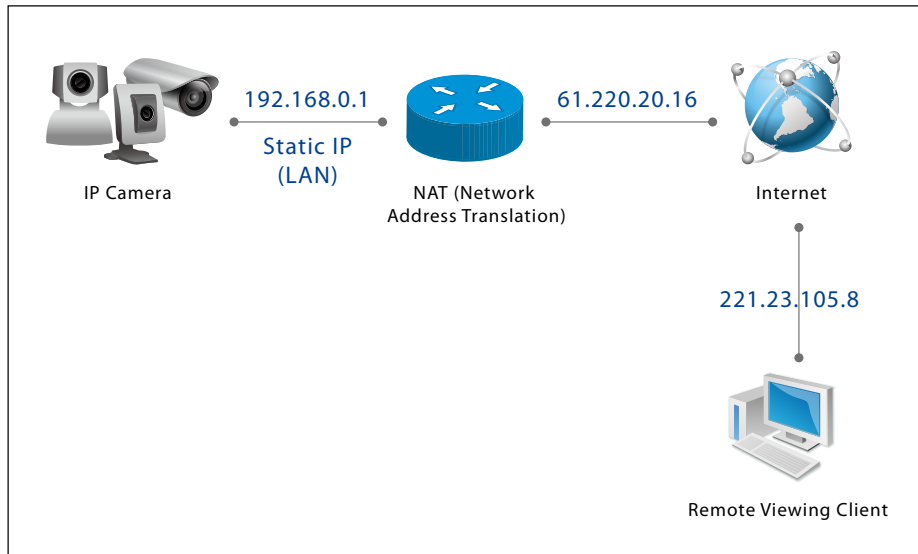

Figure 9-6. Remote viewing via browser

The figure above shows a typical connection setup in which:

- the IP camera has a static virtual IP address of 192.168.0.1
- the WAN IP address at the IP camera site is 61.220.20.16.
- the client (user) is trying to receive the video / audio stream remotely.

To successfully view the live video streamed from the IP camera, you need to:

1. Ensure that the camera's image quality setting stays within the bandwidth limit of your local network. You can check the camera's image quality setting in [Setup] > [Video]. If your quality setting exceeds your upstream bandwidth limit, you will experience stuttering video or black and blank screen.

Users	
Network	
Ethernet	
Wireless	
Advance	
DDNS	
NTP Server	time.stdtime.gov.tw
DDNS Server	Disabled DDNS
HTTP Server	Port: 80
RTSP Server	Port: 554

Figure 9-7. Advanced network setup

2. Check the ports used by the camera in [Setup] > [Network] and note down the HTTP and RTSP server ports, in this case, ports 80 and 554 respectively.
3. Enable port forwarding on the router your camera connects to and allow traffic on ports the camera is using. You may need to consult the manufacturer of your router for setting details. Note that your router may require a reboot after port forwarding is set. The following figure exemplifies the router settings you need to make in order to remotely view the IP camera.

<input checked="" type="checkbox"/>	Name IP Cam HTTP	<< Application Name	TCP 80	Schedule Always
	IP Address 192.168.0.170	<< Computer Name	UDP	Inbound Filter Allow All
<input checked="" type="checkbox"/>	Name IP Cam RTSP	<< Application Name	TCP 554	Schedule Always
	IP Address 192.168.0.170	<< Computer Name	UDP	Inbound Filter Allow All

Figure 9-8. Port forwarding

Having taken the above steps, you should be able to log in to the IP camera from a remote location by entering the DDNS address or the static IP address in the location field of a web browser (depending on your configuration). For example, in this case, you should enter "http://61.220.20.16:80" into the location field of Internet Explorer to access the IP camera.



Important:

- If you have multiple IP cameras installed on a network, you will need to change the HTTP and RTSP port on them manually so each one of them will use a different port. E.g. changing the HTTP and RTSP port for the 2nd device to 81 and 555 respectively and accessing the 2nd device by logging on to http://61.220.20.16:81.
- When configuring port forwarding/mapping on your router, note that the public RTSP port must be equal to the internal RTSP port used by the IP camera. For instance, if the IP camera uses RTSP port 554 internally, then its mapped public RTSP port on the router should be 554 too. Though the same does not apply to the camera's HTTP port. The camera using HTTP port 80 can have 8080 as its mapped public HTTP port on the router.

DDNS Configuration

DDNS allows you to tie your IP camera's IP address to a hostname with which you can access your camera over the Internet. If your IP camera obtains IP address via DHCP mode (automatic assignment of IP address), you can enable the DDNS feature under the IP camera's network setting and register for a DDNS (Dynamic DNS) service. The hostname can be obtained from Compro's free iDDNS service or by applying from other DDNS service providers such as DynDNS or no-ip. After you complete DDNS service application, you can then log in to the IP camera's setup page, and look for [Network] > [DDNS] and provide all the required information and save the settings.

Using Compro iDDNS Service

If you want to use Compro iDDNS service, you can run the Compro iWizard again and choose [Yes] in the step for iDDNS setup and then input your preferred address and click [Check Availability] to check whether the inputted address has been used. When successful, you can click [Create Shortcut] button to create a shortcut on your desktop for convenient access.



Figure 9-9. DDNS setup in iWizard

The iDDNS is a free DDNS service provided by Compro. If you are using dynamic IP, you may want to apply for DDNS (Dynamic Domain Name Server) service to create a hostname that links to the IP address on your home or office network. So even if the IP address changes, you can still use an easy-to-remember URL to quickly access your IP camera anytime, anywhere. After successfully obtaining the iDDNS address, you only need to log on to [http://xxx \(your preferred address\).iddns.org](http://xxx (your preferred address).iddns.org) to access your IP camera on a web browser.

If your local LAN network and router sit behind a firewall, you'll have to set a HTTP port (that the IP camera will use) and allows inbound access on this port. For example, if you set the HTTP port "2001" for your IP camera, your IP camera's address will be "[http://xxx \(your preferred address\).iddns.org:2001](http://xxx (your preferred address).iddns.org:2001)".

If you see the orange exclamation mark next to the HTTP or RTSP port field after performing system diagnosis with iWizard, it means you have to set up the port forwarding on your router to enables access to the IP camera from external network (the Internet). Refer to the "Remote Viewing via Internet Explorer" section of this manual and look for "Port Forwarding". You may also need to consult the manufacturer of your router for setting instructions.



Symptoms, Causes and Solutions

Listed below are some other frequently asked questions and their answers.

Symptom	Possible Cause / Solution
Problem accessing on the LAN network using web browser.	<p>The camera is not powered on. Make sure the camera has been powered on for over 1 minute and its LED status indicator is lit.</p>
	<p>The Ethernet cable is not firmly connected to the camera. Check if the Ethernet cable is securely connected to the Ethernet port of the camera and to the network switch. When the camera has successfully established connection, the LED status indicator appears blue.</p>
	<p>The Ethernet cable is damaged. Try using a different Ethernet cable to determine whether the current cable is faulty. Sometimes the a faulty Ethernet cable can result in weird connection issues.</p>
	<p>The entered IP address is incorrect. Check if the IP address you entered matches the IP address of your camera. If you are certain that your camera is configured with the same subnet mask as that of your PC, you can first disconnect other cameras, and then run the iWizard to scan the camera on your network. You shall then see the camera's IP address on your network. (Note if you are running Windows 7/ Vista, you need to run iWizard tool with system administrator rights. Simply right click on the iWizard icon on your desktop, and select "Run as administrator")</p> <p>If you're not sure whether your camera is on the same subnet with your PC, reconnect your camera to your PC directly (configure the IP address of your PC as 192.168.0.X), and run iWizard again to reconfigure its subnet address to match that of your PC. Then reconnect it back to the router or switch and run iWizard again.</p>
	<p>The viewing PC is not connected to the LAN network. Check if your viewing PC has a successful connection to the LAN network. You can open a command prompt window (by pressing Winkey + R and input "cmd" and hit OK) and then input "ipconfig" and press [Enter]. When your PC is connected to the network, it will display information on your IP address, subnet mask, etc.</p>

Symptom	Possible Cause / Solution
Problem accessing via wireless connection	<p>The wireless adapter is not firmly plugged into the camera's USB socket. Check if the wireless adapter is firmly plugged into the USB socket on camera. When camera has established wireless connection successfully, the LED status indicator of the wireless dongle will appear green and blue.</p>
	<p>The wireless settings are not configured properly. Check if the wireless settings are configured correctly. Go to the camera's Wireless Settings page and make sure you have inputted the right IP address, SSID and Keyphrase.</p>
	<p>The wireless connection is broken. If you intend to access your camera by way of wireless connection, please check that:</p> <ol style="list-style-type: none"> 1. the IP camera is connected to the correct wireless access point. 2. you have correctly set the encryption type and key for the wireless connection. If you didn't use a router on your network, the default IP address for the camera will be 192.168.0.128. <p>You can check the status of the connection by logging on to your router's maintenance page or page titled with similar wording. Consult with the manufacturer of your router for detailed instruction.</p>
Scanning for and connecting to wireless AP takes a long while	<p>Too many wireless APs nearby. The amount of time taken to scan wireless APs depends on the number of wireless APs around the camera. If there are too many wireless APs (30 or more), it may take 3 minutes to complete the scanning process. A possible workaround is to turn down the video setting a notch temporarily, and then turn it up again after you have completed configuring wireless connection. For example, you can first set your video setting as QVGA, MPEG-4, 5fps, 512Kbps. Then go to network page for wireless connection setup, and set the video setting back to its original state. This might be helpful for reducing the scanning time.</p>
Successful login to the camera but no image is displayed	<p>The Compro ActiveX component is not installed. If you are viewing the camera video on Internet Explorer, make sure you have installed and enabled Compro ActiveX component. Open your Internet Explorer browser and go to [Tools] > [Manage Add-ons] and check that you've got the "ComproClientActivex" control component registered and enabled. Refer to the "Trouble with the ActiveX Client" section of this manual for further help.</p>
	<p>The VLC plugin is not installed for non-IE browser. If you are viewing camera video on Firefox, Safari, or Chrome, make sure your VLC plugin is properly installed. (Visit www.videolan.org/vlc/ to download the codec.)</p>

Symptom	Possible Cause / Solution
<p>Successful access on local network but having problem accessing from the Internet.</p>	<p>The entered hostname/WAN IP address is incorrect. Make sure you entered the correct hostname (if you use iDDNS) or the WAN(Internet) IP address of your camera in the location field of the web browser.</p>
	<p>The LAN network is not connected to Internet. You need to have access to the Internet when trying to view your network camera remotely. Equally speaking, your camera installed on a LAN network also needs to have access to the Internet for it to be accessed remotely. Check if you can browse the Internet on your LAN network. If not, contact your network administrator for assistance.</p>
	<p>The camera's WAN IP address has changed but yet to be updated into DNS cache. If you use DDNS service, the information of your camera's IP address and the domain name the IP address is linked to is stored in the DNS cache. The cache is used to retrieve the IP information by the DNS server which translates entered hostname into the camera's IP address. Though the information is updated every few minutes (determined by the value of TTL, Time to Live), occasionally the DNS information changes (e.g. your camera acquires a new IP address) but the old information is still stored in the cache, resulting in connection failure.</p> <p>When this happens, try waiting a few minutes for the new IP information to be updated onto DNS server and then retry connection, or try to decrease the TTL value. If it still doesn't work, refer to other possible causes and solutions, or contact Compro for technical support.</p>
	<p>The router's configuration does not allow incoming traffic to the camera. If you want to make your camera located on a LAN network accessible from the Internet, you need to enable port forwarding on your router and allow incoming traffic on the HTTP and RTSP port your camera is using (your router may require a reboot after port forwarding is set). Refer to the "Remote Viewing via Internet Explorer" section in the user manual for detailed information. If you don't know how to enable port forwarding on the router, consult the manufacturer of your router for instruction.</p>

Symptom	Possible Cause / Solution
Network diagnosis shows error icon.	<p>Network connection error. The network connection test verifies if the camera has successfully connected to the LAN network. When the diagnosis result shows a red exclamation mark icon () for network connection, it means the camera fails to connect to LAN network. Check if the LAN cable is securely connected to the Ethernet port of the camera and to your hub/router, or check if the LAN cable is functioning normally. Also check whether the gateway address your camera uses is identical to that of your router.</p>
	<p>Internet connection error. The Internet connection test verifies if the camera is connected to the Internet. When the diagnosis result shows a red exclamation mark icon () for Internet connection, it may represent a failed connection to the LAN network. It could also be caused by inappropriate settings on your router that makes your router unable to connect to the Internet, such as wrong PPPoE user name/password, or wrong WAN IP setting (when your ISP provides you with fixed IP address). See if your PC connected to your router can also access the Internet. If not, consult your ISP/ router manufacturer for correct Internet setting. If your router can connect to the Internet but your camera connected to your router cannot, check whether the IP, subnet mask and gateway is correctly set on your camera.</p>
	<p>HTTP/RTSP port error. HTTP port is used for transmitting web pages, commands over the Internet. RTSP port is used for sending video/audio data. These two test items will fail whenever port forwarding is not enabled. Make sure you have enabled port forwarding on your router and have allowed traffic on ports your IP camera is using. Refer to the "Remote Viewing via Internet Explorer" section of this manual for more information.</p>
Problem using DDNS service.	<p>The user information is incorrect. Go to main setup page. On the left menu, select [Network] > [DDNS], and check if the ID and password is correct. Also check with your service provider to see if your service account is active.</p>
	<p>The entered address is incorrect. Go to main setup page and select [Network] > [DDNS] on the left menu, and then check if the iDDNS service is enabled and if you have the correct address.</p>
	<p>Incoming traffic to the network camera is not allowed. Please refer to the "Remote Viewing via Internet Explorer" section in the troubleshooting chapter of this manual and look for instruction on enabling port forwarding.</p>

Symptom	Possible Cause / Solution
Problem using iWizard.	<p>The IP camera's IP address is repeatedly displayed as "DHCP mode" in iWizard. This either means the camera cannot obtain an IP address from DHCP Server, or indicates that the IP address assigned to the camera is not on the same subnet as the LAN network. Please try to set the camera's IP address to a static one. Note that you have to set the DNS server for your camera (in the advanced network settings) if your camera uses a static IP address. Consult with your ISP (Internet Service Provider) for the most appropriate DNS server setting; or simply set DNS server as 8.8.8.8 or 8.8.4.4, which is the address of a free DNS server powered by Google.</p>
	<p>The camera's IP address is shown as "169.254.x.x" in iWizard. When Compro IP Camera fails to obtain an IP Address from a DHCP server (typically a network router, which has the ability to assign an IP address to IP camera automatically), the camera will generate an IP address itself so that it can be found on the network using Compro iWizard. In order to resolve this, you need to check the physical connection between your Compro IP Camera and the router, or consult your network administrator about the function of DHCP server.</p>
Part of image becomes pixelated / Square color blocks are seen	<p>Network bandwidth is insufficient. Without sufficient bandwidth, video quality will deteriorate and image errors like pixelation or frame-drop may occur. When you view your camera remotely from the Internet, your camera needs sufficient upload bandwidth to transmit video stream and you need sufficient download bandwidth to download video stream at the remote location.</p> <p>To gain satisfactory video quality, ensure there is sufficient upload bandwidth available to your network camera by taking the following actions:</p> <ol style="list-style-type: none"> 1. Contact your Internet Service Provider (ISP) to confirm the upload/download speed limit of your service. If the bit rate of the video stream is set at 512Kbps or higher but your Internet service only provides a max. of 512Kbps for upload bandwidth, then try to lower the bit rate setting in [Setup] > [Video]. 2. Run a network speed diagnostics on WebVUer to determine the bandwidth level of the currently connected network. To do so, log in to your camera using WebVUer and go to [Setup] > [Network] > [Network Bandwidth]. When the speed diagnostics is done, the WebVUer will advise you of the appropriate setting. <p>Consider the following actions to ensure sufficient download bandwidth at your remote viewing location:</p> <ol style="list-style-type: none"> 1. Contact your Internet Service Provider (ISP) to confirm the upload/download speed limit of your service. If the bit rate of the video stream is set at 3Mbps or higher but your Internet service only provides a max. of 2Mbps download bandwidth, then try to lower the bit rate setting in [Setup] > [Video]. 2. Upgrade to Gigabit network switch. Regular 10/100 Mbps network switch cannot handle multiple megapixel streams, thus you may consider upgrading to Gigabit network switch when building up your network infrastructure. 3. While you are viewing the network camera remotely, shutting down any other applications that are also consuming the network bandwidth in the background.

Symptom	Possible Cause / Solution
Video appears very blocky	Video bit rate is set too low. Blocky video is usually caused by non-correspondence of video resolution and bit rate. Simply put, the video bit rate is too low. Please try to set the bit rate to a higher one or set the video resolution to a lower one.
Ghost image is seen	Network quality is not good enough. This is a common phenomenon when the quality of network is not good or the video setting is too high. Please try to set the bit rate of the camera to a lower one and see if the problem remains.
Video is not real-time	Network is congested. First, check if the network latency is too long. If the network is too congested, this may happen. Second, check the video buffer setting in the video settings page (setup > video > video buffer). Please set it as standard. (The video buffer option is only available in firmware 2.03 or above.)
Gray images are seen repeatedly	The network quality is not good. Seeing lots of gray images in live view mode indicates that many data packets which carry video data are dropped during the transmission. This might be caused by network congestion, wireless congestion, or the limited upload/download bandwidth of your network. To measure the upload/download capability of your network, you can use either the "Network Bandwidth" testing tool in the network settings page, or visit speedtest.net (http://speedtest.net/). When using wired connection: Please test your bandwidth in the aforementioned way to determine whether this has been the result of poor network quality. Or try connecting your camera to your viewing computer directly to see if there are any faulty devices on your network. When using wireless connection: Besides the possible network bandwidth issue, the wireless signal strength could also come into play. Low wireless signal strength may also lead to the same problem. You can check the wireless signal strength in the camera's network settings page. The wireless signal level seen in the network settings is measured in dBm. To gain the optimal wireless connection quality, a signal level greater than -60 dBm is recommended. When the signal level gets too low, you may have to place your wireless Access Point in a different location, use a wireless repeater, or remove obstacles between the camera and the wireless AP.
A warning message saying "Your video quality is too high for your internet bandwidth" popped up	Network quality is not good enough. This means the camera's browser interface, WebVUer, could not receive a steady stream of video data from your camera. The loss of video data might also be caused by network congestion or insufficient bandwidth. Please refer to other related troubleshooting tips. Additionally, if the CPU usage on your viewing computer is too high, the same warning message will be showed. You can monitor the CPU usage by right clicking on your Windows taskbar and choose "task manager", and then click the Performance tab.
Video stream is lost over a short span	Network quality is not good enough. This could be caused either by the unstable connection between the camera and the WebVUer or by the insufficient network bandwidth. Please try to set the bit rate of the camera to a lower one and try again.

Contacting Compro Technical Support

Before you submit an email for support, please check the troubleshooting section in the user manual. You may fill out the form (<http://comprousa.com/en/form.htm>) or directly email to support@comprousa.com.

Compro Technology, Inc.

www.comprousa.com

Tel. +886 2 2918 0169, Fax +886 2 2915 2389

4F, No.12, Alley 6, Lane 45, Pao Shin Road, Hsintien District, New Taipei City 231, Taiwan

Chapter 10: Technical Specifications

TN60/TN60W Technical Specifications

Camera	
Image Sensor	1/7" progressive scan CMOS sensor
Lens	<ul style="list-style-type: none"> Focal length: 2.0 mm Max aperture ratio: F2.8 Fixed iris
Zoom	10x digital zoom
Angle of View	55° horizontal
Focusing Range	0.5 m ~ INF
Minimum Illumination	1.0 lux
Shutter Time	1/5 ~ 1/16000 sec.
Video	
Video Compression	M-JPEG, H.264 (MPEG-4 Part 10)
Resolution & Frame Rate	160x120, 320x240, 640x480
Frame Rate	Up to 30 FPS at 640x480
Video Streaming	Dual streaming supported
Image Settings	<ul style="list-style-type: none"> Adjustable image size and quality AGC, AWB, AES Configurable brightness, contrast, saturation and sharpness
Audio	
Audio Communication	Two-way audio with built-in microphone and Speaker
Audio Compression	G.711 PCM 64Kbit/sec
Network	
Wireless LAN	Optional 802.11n USB wireless adapter
Security	<ul style="list-style-type: none"> User name / password protection WEP/WPA/WPA2 encryption (wireless network)
Protocols	TCP/IP, HTTP, UDP, FTP, ICMP, ARP, DHCP, NTP, DDNS, DynDNS, UPnP, RTP, RTSP, RTCP, SMTP, IGMP, 3GPP, IPv4
Ethernet	10/100 Base-T, autosensing, RJ-45
Firmware	
Firmware	<ul style="list-style-type: none"> Support UPnP Support online firmware update
Web Browser	
Internet Explorer (ActiveX)	<ul style="list-style-type: none"> Remotely view and configure camera on Internet Explorer Record video and capture snapshots on PC Alarm and event management: FTP and SMS/Email alert messaging
Supported Viewing Devices	<ul style="list-style-type: none"> PC, laptop, tablet, nettop, MID with IE8 iPhone®/iPad, BlackBerry, Android™, WM, PDA, or cell phones with web browser (MJPEG mode)
Mobile Surveillance	

Smartphone App	Free mobile applications for iPhone and Android <ul style="list-style-type: none"> • Push notification • Smart motion detection • Share video to others • Watch multiple channels at the same screen (not support iPhone/iPad)
MJPEG Mode	View live image on mobile web browser
3GPP Mode	View live video on 3G cell phone (3GPP Streaming)
General	
Local Storage	microSD/SDHC card slot (supports local storage of snapshots and video recordings)
PIR Sensor	Effective distance up to 6M (horizontal)
Operating Conditions	0 °C ~ 40 °C (32 °F ~ 104 °F)
Power Supply	DC 5V/2A
Viewing System Requirements	<ul style="list-style-type: none"> • Computer with 2.8GHz dual-core processor and 2GB memory or above • Operating system: Windows XP SP3, Vista SP1, Windows 7, Windows 8, Mac OS 10.6 (Live view in MJPEG mode) • Internet browser: Internet Explorer 8.0 or later; non-IE browsers require 3rd-party VLC plug-in
Package Contents	<ul style="list-style-type: none"> • Network camera • Software CD • Quick installation guide • Ethernet cable • Screws for ceiling mounting • Screw anchor • Power adapter
Dimensions	64 x 74.7 x 110 mm (including bracket)

* Specifications are subject to change without prior notice.

Chapter 11: Appendix

Examples of Port Forwarding Setup on Routers

The following are some examples of router configurations with reagr to port forwarding / port mapping / virtual server on some popular router products. You can also log on to portforward.com for more port forwarding setup examples on other router products.

Abocom WAA813rn Port Forwarding Setup

Abocom WAA813rn Port Forwarding Setup

Port Forwarding

Enable Port Forwarding:

IP Address: 192.168.1.100

Protocol: Both

Port Range: 80-80

Comment: http

Local IP Address	Protocol	Port Range	Comment	Select
------------------	----------	------------	---------	--------

Abocom WAA813rn Port Forwarding Setup

Port Forwarding

Enable Port Forwarding:

IP Address:

Protocol: Both

Port Range: 80-80

Comment: http

Local IP Address	Protocol	Port Range	Comment	Select
192.168.1.100	TCP-UDP	80	http	<input type="checkbox"/>
192.168.1.100	TCP-UDP	80	http	<input type="checkbox"/>

ASUS RT-N12 Virtual Server Setup

ASUS RT-N12 Virtual Server Setup

Virtual Server

Enable Virtual Server?:

Famous Server List: Please select

Famous Game List: Please select

Service Name	Port Range	Local IP	Local Port	Protocol	Protocol No.
http	80	192.168.0.100	80	BOTH	

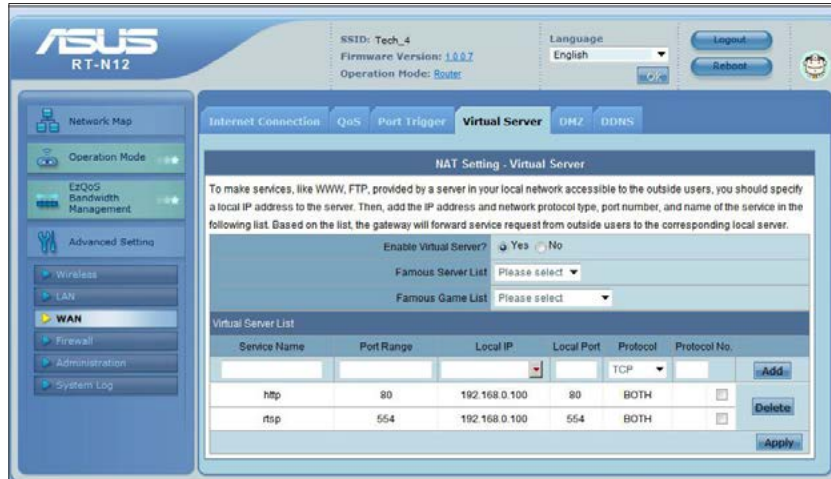

D-Link DIR-655 Virtual Serve Setup

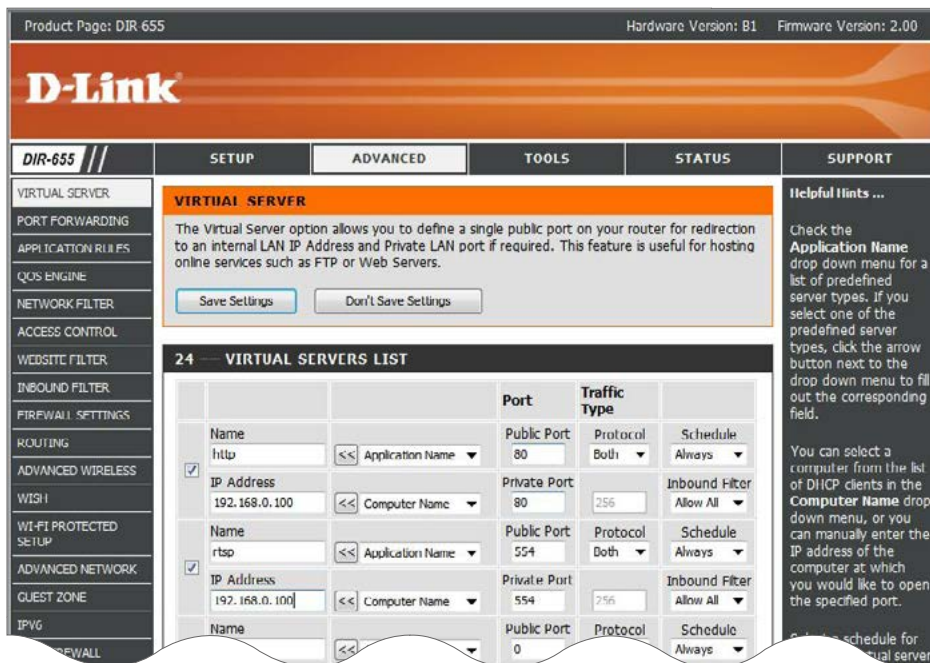

TP-LINK wr1043n Virtual Server Setup

TP-LINK 300M Wireless N Gigabit Router
Model No. TL-WR1043N / TL-WR1043ND

Status
Quick Setup
QSS
Network
Wireless
DHCP
Network Sharing
Forwarding
Virtual Servers
Port Triggering
DMZ
IPoP
System

Add or Modify a Virtual Server Entry

Service Port: 80 (XX-XX or XX)
IP Address: 192.168.0.100
Protocol: ALL
Status: Enabled
Common Service Port: --Select One--

Save Back

Virtual Servers Help

Virtual servers can be used for setting up public services on your LAN. A virtual server is defined as a service port, and all requests from Internet to this service port will be redirected to the computer specified by the server IP. Any PC that was used for a virtual server must have a static or reserved IP address because its IP address may change when using the DHCP function.

- Service Port** - The numbers of External Ports. You can enter a service port or a range of service ports. The format is XXX-YYY,XXX is Start port, YYY is End port.
- IP Address** - The IP address of the PC running the service application.
- Protocol** - The protocol used for this application, either TCP, UDP, or All (all protocols supported by the Router).
- Status** - The status of this entry. "Enabled" means the virtual server entry is enabled.
- Common Service Port** - Some common ports already exist in the pull-down list.
- Modify** - To modify an entry.

TP-LINK 300M Wireless N Gigabit Router
Model No. TL-WR1043N / TL-WR1043ND

Status
Quick Setup
QSS
Network
Wireless
DHCP
Network Sharing
Forwarding
Virtual Servers
Port Triggering
DMZ
IPoP
System

Virtual Servers

ID	Service Port	IP Address	Protocol	Status	Modify
1	80	192.168.2.100	ALL	Enabled	Modify Delete
2	554	192.168.2.100	ALL	Enabled	Modify Delete

Add New Enable All Disable All Delete All

Previous Next

Virtual Servers Help

Virtual servers can be used for setting up public services on your LAN. A virtual server is defined as a service port, and all requests from Internet to this service port will be redirected to the computer specified by the server IP. Any PC that was used for a virtual server must have a static or reserved IP address because its IP address may change when using the DHCP function.

- Service Port** - The numbers of External Ports. You can enter a service port or a range of service ports. The format is XXX-YYY,XXX is Start port, YYY is End port.
- IP Address** - The IP address of the PC running the service application.
- Protocol** - The protocol used for this application, either TCP, UDP, or All (all protocols supported by the Router).
- Status** - The status of this entry. "Enabled" means the virtual server entry is enabled.
- Common Service Port** - Some common ports already exist in the pull-down list.
- Modify** - To modify an entry.

TP-LINK 300M Wireless N Gigabit Router
Model No. TL-WR1043N / TL-WR1043ND

Status
Quick Setup
QSS
Network
Wireless
DHCP
Network Sharing
Forwarding
Virtual Servers
Port Triggering
DMZ
IPoP
System

Add or Modify a Virtual Server Entry

Service Port: 554 (XX-XX or XX)
IP Address: 192.168.0.100
Protocol: ALL
Status: Enabled
Common Service Port: --Select One--

Save Back

Virtual Servers Help

Virtual servers can be used for setting up public services on your LAN. A virtual server is defined as a service port, and all requests from Internet to this service port will be redirected to the computer specified by the server IP. Any PC that was used for a virtual server must have a static or reserved IP address because its IP address may change when using the DHCP function.

- Service Port** - The numbers of External Ports. You can enter a service port or a range of service ports. The format is XXX-YYY,XXX is Start port, YYY is End port.
- IP Address** - The IP address of the PC running the service application.
- Protocol** - The protocol used for this application, either TCP, UDP, or All (all protocols supported by the Router).
- Status** - The status of this entry. "Enabled" means the virtual server entry is enabled.
- Common Service Port** - Some common ports already exist in the pull-down list.
- Modify** - To modify an entry.

