

# Certificate

Issue Date: 6/30/2011  
Ref. Report No. ISL-11HE169CE

Product Name : Network Attached Storage  
: TS-879U-RP; TS-EC879U-RP; TS-879U-RP+; TS-EC879U-RP+; TS-879U II-RP; TS-EC879U II-RP; NAS-879UG-RP; NAS-EC879UG-RP; NAS-879UG-RP+; NAS-EC879UG-RP+; NAS-879UG II-RP; NAS-EC879UG II-RP; NSS508R; VS-8040U-RP Pro; VS-8032U-RP Pro; VS-8024U-RP Pro; Model(s) : NVR-8040U-RP Pro; NVR-8032U-RP Pro; NVR-8024U-RP Pro; NVR-8040UG-RP Pro; NVR-8032UG-RP Pro; NVR-8024UG-RP Pro; NVR-8000U-RP Pro; NVR-8000U-RP Pro; NVR-8000UG-RP Pro; VS-8056U-RP Pro; VS-8048U-RP Pro; NVR-8056U-RP Pro; NVR-8048U-RP Pro; NVR-8056UG-RP Pro; NVR-8048UG-RP Pro  
Responsible Party : QNAP Systems, Inc.  
Address : 2F., No. 22, Zhongxing Rd., Xizhi Dist., New Taipei City 221, Taiwan (R. O. C.)

We, **International Standards Laboratory**, hereby certify that:

The device bearing the trade name and model specified above has been shown to comply with the applicable technical standards as indicated in the measurement report and was tested in accordance with the measurement procedures specified in European Council Directive- EMC Directive 2004/108/EC. The device was passed the test performed according to :



## Standards:

EN 55022:2006 +A1:2007 / CISPR 22:2005 +A1:2005 / AS/NZS CISPR 22: 2009  
EN 61000-3-2: 2006 and IEC 61000-3-2: 2005  
EN 61000-3-3: 2008 and IEC 61000-3-3: 2008  
EN55024:1998+A1:2001+A2:2003 / CISPR 24:1997+A1:2001+A2:2002  
EN 61000-4-2: 2009 and IEC 61000-4-2: 2008  
EN 61000-4-3: 2006 + A1:2008 and IEC 61000-4-3: 2006 +A1:2007  
EN 61000-4-4: 2004 +A1:2010 and IEC 61000-4-4: 2004 +A1:2010  
EN 61000-4-5: 2006 and IEC 61000-4-5: 2005  
EN 61000-4-6: 2009 and IEC 61000-4-6: 2008  
EN 61000-4-8: 1993+A1: 2001 and IEC 61000-4-8: 1993+A1: 2000  
EN 61000-4-11: 2004 and IEC 61000-4-11: 2004

I attest to the accuracy of data and all measurements reported herein were performed by me or were made under my supervision and are correct to the best of my knowledge and belief. I assume full responsibility for the completeness of these measurements and vouch for the qualifications of all persons taking them.

**International Standards Laboratory**

*Jim Chu*  
Jim Chu / Director

## Hsi-Chih LAB:

No. 65, Gu Dai Keng St., Hsichih District,  
New Taipei City 22117, Taiwan  
Tel: 886-2-2646-2550; Fax: 886-2-2646-4641



## Lung-Tan LAB:

No. 120, Lane 180, San Ho Tsuen, Hsin Ho Rd.  
Lung-Tan Hsiang, Tao Yuan County 325, Taiwan  
Tel: 886-3-407-1718; Fax: 886-3407-1738



# **CE MARK TECHNICAL FILE**

## **AS/NZS EMC CONSTRUCTION FILE**

of

Product Name

**Network Attached Storage**

Model

**TS-879U-RP; TS-EC879U-RP; TS-879U-RP+;  
TS-EC879U-RP+; TS-879U II-RP; TS-EC879U II-RP;  
NAS-879UG-RP; NAS-EC879UG-RP; NAS-879UG-RP+;  
NAS-EC879UG-RP+; NAS-879UG II-RP; NAS-EC879UG II-RP;  
NSS508R; VS-8040U-RP Pro; VS-8032U-RP Pro; VS-8024U-RP  
Pro; NVR-8040U-RP Pro; NVR-8032U-RP Pro; NVR-8024U-RP  
Pro; NVR-8040UG-RP Pro; NVR-8032UG-RP Pro;  
NVR-8024UG-RP Pro; VS-8000U-RP Pro; NVR-8000U-RP Pro;  
NVR-8000UG-RP Pro; VS-8056U-RP Pro; VS-8048U-RP Pro;  
NVR-8056U-RP Pro; NVR-8048U-RP Pro; NVR-8056UG-RP  
Pro; NVR-8048UG-RP Pro**

Contains:

1. Declaration of Conformity
2. EN55022/CISPR 22, AS/NZS CISPR 22 EMI test report
3. EN55024/CISPR 24, EN61000-3-2 / IEC 61000-3-2, and EN61000-3-3 / IEC 61000-3-3 test report
4. Certificate of EN60950-1
5. Block Diagram and Schematics
6. Users' manual

## Declaration of Conformity

Name of Responsible Party: QNAP Systems, Inc.

Address of Responsible Party: 2F., No. 22, Zhongxing Rd., Xizhi Dist., New Taipei City 221, Taiwan (R. O. C.)

Declares that product: Network Attached Storage

Model: TS-879U-RP; TS-EC879U-RP; TS-879U-RP+;  
 TS-EC879U-RP+; TS-879U II-RP; TS-EC879U II-RP;  
 NAS-879UG-RP; NAS-EC879UG-RP;  
 NAS-879UG-RP+; NAS-EC879UG-RP+; NAS-879UG  
 II-RP; NAS-EC879UG II-RP; NSS508R;  
 VS-8040U-RP Pro; VS-8032U-RP Pro; VS-8024U-RP  
 Pro; NVR-8040U-RP Pro; NVR-8032U-RP Pro;  
 NVR-8024U-RP Pro; NVR-8040UG-RP Pro;  
 NVR-8032UG-RP Pro; NVR-8024UG-RP Pro;  
 VS-8000U-RP Pro; NVR-8000U-RP Pro;  
 NVR-8000UG-RP Pro; VS-8056U-RP Pro;  
 VS-8048U-RP Pro; NVR-8056U-RP Pro;  
 NVR-8048U-RP Pro; NVR-8056UG-RP Pro;  
 NVR-8048UG-RP Pro

Assembled by: Same as above  
 Address: Same as above

Conforms to the EMC Directive 2004/108/EC as attested by conformity with the following harmonized standards:

EN 55022:2006 +A1:2007 / CISPR 22:2005 +A1:2005 / AS/NZS CISPR 22: 2009: Limits and methods of measurement of Radio Interference characteristics of Information Technology Equipment.

EN55024:1998+A1:2001+A2:2003 / CISPR 24:1997+A1:2001+A2:2002: Information technology equipment-Immunity characteristics-Limits and methods of measurement.

Standard	Description	Results	Criteria
EN 61000-4-2:2009 IEC 61000-4-2:2008	Electrostatic Discharge	Pass	B
EN 61000-4-3:2006+A1:2008 IEC 61000-4-3:2006+A1:2007	Radio-Frequency, Electromagnetic Field	Pass	A
EN 61000-4-4: 2004 +A1:2010 IEC 61000-4-4: 2004 +A1:2010	Electrical Fast Transient/Burst	Pass	B
EN 61000-4-5: 2006 IEC 61000-4-5: 2005	Surge	Pass	B
EN 61000-4-6:2009 IEC 61000-4-6:2008	Conductive Disturbance	Pass	A
EN 61000-4-8: 1993+A1: 2001 IEC 61000-4-8: 1993+A1: 2000	Power Frequency Magnetic Field	Pass	A

<to be continued>

Standard	Description	Results	Criteria
EN 61000-4-11: 2004 IEC 61000-4-11: 2004	Voltage Dips / Short Interruption and Voltage Variation		
	>95% in 0.5 period	Pass	B
	30% in 25 period	Pass	C
	>95% in 250 period	Pass	C

Standard	Description	Results
EN 61000-3-2: 2006 IEC 61000-3-2: 2005	Limits for harmonics current emissions	Pass
EN 61000-3-3: 2008 IEC 61000-3-3: 2008	Limits for voltage fluctuations and flicker in low-voltage supply systems.	Pass

Conforms to the Low Voltage Directive 2006/95/EC, 93/68/EEC as attested by conformity with the following harmonized standard:

EN60950-1:2006+A11:2009: Safety of Information Technology Equipment  
Including electrical business equipment

*We, QNAP Systems, Inc., hereby declare that the equipment bearing the trade name and model number specified above was tested conforming to the applicable Rules under the most accurate measurement standards possible, and that all the necessary steps have been taken and are in force to assure that production units of the same equipment will continue to comply with the requirements.*

-----  
QNAP Systems, Inc.

**Date: 6/30/2011**

### Declaration of Conformity

Name of Responsible Party: QNAP Systems, Inc.

Address of Responsible Party: 2F., No. 22, Zhongxing Rd., Xizhi Dist., New Taipei City 221, Taiwan (R. O. C.)

Declares that product: Network Attached Storage

Model: TS-879U-RP; TS-EC879U-RP; TS-879U-RP+;  
 TS-EC879U-RP+; TS-879U II-RP; TS-EC879U II-RP;  
 NAS-879UG-RP; NAS-EC879UG-RP;  
 NAS-879UG-RP+; NAS-EC879UG-RP+; NAS-879UG II-RP; NAS-EC879UG II-RP; NSS508R;  
 VS-8040U-RP Pro; VS-8032U-RP Pro; VS-8024U-RP Pro; NVR-8040U-RP Pro; NVR-8032U-RP Pro; NVR-8024U-RP Pro; NVR-8040UG-RP Pro; NVR-8032UG-RP Pro; NVR-8024UG-RP Pro; VS-8000U-RP Pro; NVR-8000U-RP Pro; NVR-8000UG-RP Pro; VS-8056U-RP Pro; VS-8048U-RP Pro; NVR-8056U-RP Pro; NVR-8048U-RP Pro; NVR-8056UG-RP Pro; NVR-8048UG-RP Pro

Assembled by: Same as above  
 Address: Same as above

Conforms to the C-Tick Mark requirement as attested by conformity with the following standards:

EN 55022:2006 +A1:2007 / CISPR 22:2005 +A1:2005 / AS/NZS CISPR 22: 2009: Limits and methods of measurement of Radio Interference characteristics of Information Technology Equipment.

EN55024:1998+A1:2001+A2:2003 / CISPR 24:1997+A1:2001+A2:2002: Information technology equipment-Immunity characteristics-Limits and methods of measurement.

Standard	Description	Results	Criteria
EN 61000-4-2:2009 IEC 61000-4-2:2008	Electrostatic Discharge	Pass	B
EN 61000-4-3:2006+A1:2008 IEC 61000-4-3:2006+A1:2007	Radio-Frequency, Electromagnetic Field	Pass	A
EN 61000-4-4: 2004 +A1:2010 IEC 61000-4-4: 2004 +A1:2010	Electrical Fast Transient/Burst	Pass	B
EN 61000-4-5: 2006 IEC 61000-4-5: 2005	Surge	Pass	B
EN 61000-4-6:2009 IEC 61000-4-6:2008	Conductive Disturbance	Pass	A
EN 61000-4-8: 1993+A1: 2001 IEC 61000-4-8: 1993+A1: 2000	Power Frequency Magnetic Field	Pass	A

<to be continued>

Standard	Description	Results	Criteria
EN 61000-4-11: 2004 IEC 61000-4-11: 2004	Voltage Dips / Short Interruption and Voltage Variation		
	>95% in 0.5 period	Pass	B
	30% in 25 period	Pass	C
	>95% in 250 period	Pass	C

Standard	Description	Results
EN 61000-3-2: 2006 IEC 61000-3-2: 2005	Limits for harmonics current emissions	Pass
EN 61000-3-3: 2008 IEC 61000-3-3: 2008	Limits for voltage fluctuations and flicker in low-voltage supply systems.	Pass

*We, QNAP Systems, Inc., hereby declare that the equipment bearing the trade name and model number specified above was tested conforming to the applicable Rules under the most accurate measurement standards possible, and that all the necessary steps have been taken and are in force to assure that production units of the same equipment will continue to comply with the requirements.*

-----  
QNAP Systems, Inc.

**Date: 6/30/2011**

# CE TEST REPORT

of  
**EN55022 / CISPR 22 / AS/NZS CISPR 22**  
**Class B**  
**EN55024 / CISPR 24 / IMMUNITY**  
**EN61000-3-2 / EN61000-3-3**

Product : **Network Attached Storage**

Model(s): **TS-879U-RP; TS-EC879U-RP; TS-879U-RP+;**  
**TS-EC879U-RP+; TS-879U II-RP; TS-EC879U**  
**II-RP; NAS-879UG-RP; NAS-EC879UG-RP;**  
**NAS-879UG-RP+; NAS-EC879UG-RP+; NAS-879UG**  
**II-RP; NAS-EC879UG II-RP; NSS508R;**  
**VS-8040U-RP Pro; VS-8032U-RP Pro; VS-8024U-RP**  
**Pro; NVR-8040U-RP Pro; NVR-8032U-RP Pro;**  
**NVR-8024U-RP Pro; NVR-8040UG-RP Pro;**  
**NVR-8032UG-RP Pro; NVR-8024UG-RP Pro;**  
**VS-8000U-RP Pro; NVR-8000U-RP Pro;**  
**NVR-8000UG-RP Pro; VS-8056U-RP Pro;**  
**VS-8048U-RP Pro; NVR-8056U-RP Pro;**  
**NVR-8048U-RP Pro; NVR-8056UG-RP Pro;**  
**NVR-8048UG-RP Pro**

Applicant: **QNAP Systems, Inc.**

Address: **2F., No. 22, Zhongxing Rd., Xizhi Dist., New Taipei**  
**City 221, Taiwan (R. O. C.)**

Test Performed by:

**International Standards Laboratory**

<Hsi-Chih LAB>

\*Site Registration No.

BSMI:SL2-IN-E-0037; SL2-R1/R2-E-0037; TAF: 1178;

IC: IC4067A-1; VCCI: R-341,C-354, T-1749; NEMKO: ELA 113A

\*Address:

No. 65, Gu Dai Keng St.

Hsi\_Chih District, New Taipei City 22117, Taiwan

\*Tel: 886-2-2646-2550; Fax: 886-2-2646-4641

Report No.: **ISL-11HE169CE**

Issue Date : **6/30/2011**

This report totally contains 54 pages including this cover page and contents page.

Test results given in this report apply only to the specific sample(s) tested and are traceable to national or international standard through calibration of the equipment and evaluating measurement uncertainty herein.

This report MUST not be used to claim product endorsement by TAF, NEMKO or any agency of the Government.

This test report shall not be reproduced except in full, without the written approval of International Standards Laboratory.

## Contents of Report

1.	General.....	1
1.1	Certification of Accuracy of Test Data .....	1
1.2	Test Standards .....	2
1.3	Description of EUT .....	3
1.4	Description of Support Equipment .....	7
1.5	Software for Controlling Support Unit.....	8
1.6	I/O Cable Condition of EUT and Support Units .....	9
2.	Power Main Port Conducted Emissions .....	10
2.1	Test Setup and Procedure .....	10
2.1.1	Test Setup .....	10
2.1.2	Test Procedure .....	10
2.1.3	EMI Receiver/Spectrum Analyzer Configuration (for the frequencies tested).....	10
2.2	Conduction Test Data: Configuration 1 .....	11
3.	Telecommunication Port Conducted Emissions .....	13
3.1	Test Setup and Procedure .....	13
3.1.1	Test Setup .....	13
3.1.2	Test Procedure .....	13
3.1.3	EMI Receiver/Spectrum Analyzer Configuration (for the frequencies tested).....	13
3.2	Test Data: LAN--10M: Configuration 1.....	14
3.3	Test Data: LAN--100M: Configuration 1.....	15
3.4	Test Data: LAN--GIGA: Configuration 1 .....	16
3.5	Test Data: LAN--10M: Configuration 2.....	17
3.6	Test Data: LAN--100M: Configuration 2.....	18
3.7	Test Data: LAN--GIGA: Configuration 2 .....	19
4.	Radiated Disturbance Emissions .....	20
4.1	Test Setup and Procedure .....	20
4.1.1	Test Setup .....	20
4.1.2	Test Procedure .....	20
4.1.3	Spectrum Analyzer Configuration (for the frequencies tested) .....	21
4.2	Radiation Test Data: Configuration 1.....	22
5.	Electrostatic discharge (ESD) immunity .....	26
5.1	Electrostatic discharge (ESD) immunity test .....	26
6.	Radio-Frequency, Electromagnetic Field immunity.....	27
6.1	Radio-Frequency, Electromagnetic Field immunity test.....	27
7.	Electrical Fast transients/burst immunity .....	28
7.1	Electrical Fast transient/burst immunity test.....	28
8.	Surge Immunity .....	30
8.1	Surge immunity test.....	30
9.	Immunity to Conductive Disturbance.....	31
9.1	Immunity to Conductive Disturbance .....	31
10.	Power Frequency Magnetic Field immunity .....	32
10.1	Power Frequency Magnetic field immunity test .....	32
11.	Voltage Dips, Short Interruption and Voltage Variation immunity .....	33
11.1	Voltage Dips, Short Interruption and Voltage Variation immunity test .....	33
12.	Harmonics .....	34
12.1	Harmonics test.....	34
13.	Voltage Fluctuations .....	37
13.1	Voltage Fluctuations test.....	37
14.	Appendix.....	39



14.1	Appendix A: Test Equipment.....	39
14.1.1	Test Equipment List.....	39
14.1.2	Software for Controlling Spectrum/Receiver and Calculating Test Data.....	41
14.2	Appendix B: Uncertainty of Measurement .....	42
14.3	Appendix C: Photographs of EUT Configuration Test Set Up.....	44
14.3.1	Photo of Main Power Port Conducted Emission and Telecommunication Port Conducted Emission Measurement .....	44
14.3.2	Photo of Radiated Emission Measurement .....	46
14.3.3	Photo of ESD Measurement .....	47
14.3.4	Photo of RF Field Strength Susceptibility Measurement.....	47
14.3.5	Photo of Electrical Fast Transient/Burst Measurement .....	48
14.3.6	Photo of Surge Measurement.....	48
14.3.7	Photo of Conductive Measurement.....	49
14.3.8	Photo of Magnetic field Measurement.....	49
14.3.9	Photo of Voltage Dips Measurement.....	50
14.3.10	Photo of Harmonics and Voltage Fluctuations .....	50
14.4	Appendix D: Photographs of EUT Please refer to the File of ISL-11HE169P.....	51

# 1. General

## 1.1 Certification of Accuracy of Test Data

**Standards:** Please refer to 1.2

**Equipment Tested:** Network Attached Storage

**Model:** TS-879U-RP; TS-EC879U-RP; TS-879U-RP+;  
TS-EC879U-RP+; TS-879U II-RP; TS-EC879U II-RP;  
NAS-879UG-RP; NAS-EC879UG-RP; NAS-879UG-RP+;  
NAS-EC879UG-RP+; NAS-879UG II-RP; NAS-EC879UG  
II-RP; NSS508R; VS-8040U-RP Pro; VS-8032U-RP Pro;  
VS-8024U-RP Pro; NVR-8040U-RP Pro; NVR-8032U-RP Pro;  
NVR-8024U-RP Pro; NVR-8040UG-RP Pro; NVR-8032UG-RP  
Pro; NVR-8024UG-RP Pro; VS-8000U-RP Pro; NVR-8000U-RP  
Pro; NVR-8000UG-RP Pro; VS-8056U-RP Pro; VS-8048U-RP  
Pro; NVR-8056U-RP Pro; NVR-8048U-RP Pro;  
NVR-8056UG-RP Pro;  
NVR-8048UG-RP Pro

**Applicant:** QNAP Systems, Inc.

**Sample received Date:** 5/16/2011

**Final test Date:** EMI:refer to the date of test data  
EMS: 2011-05-27

**Test Site:** International Standards Laboratory  
OATS 01; Chamber 14; Conduction 01; Immunity01

**Test Distance:** 10M; 3M (above1GHz) (EMI test)

**Temperature:** refer to each site test data

**Humidity:** refer to each site test data

**Input power:** Conduction input power: AC 230 V / 50 Hz  
Radiation input power: AC 230 V / 50 Hz  
Immunity input power: AC 230 V / 50 Hz

**Test Result:** PASS

**Report Engineer:** Midori Su

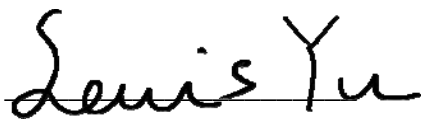
**Test Engineer:**   
Louis Yu

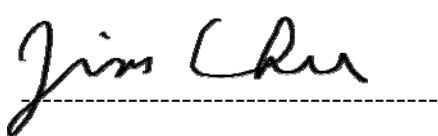
**Approved By:**   
Jim Chu / Director

## 1.2 Test Standards

The tests which this report describes were conducted by an independent electromagnetic compatibility consultant, International Standards Laboratory in accordance with the following

EN 55022:2006 +A1:2007 / CISPR 22:2005 +A1:2005 / AS/NZS CISPR 22: 2009: Class B: Limits and methods of measurement of Radio Interference characteristics of Information Technology Equipment.

EN55024:1998+A1:2001+A2:2003 / CISPR 24:1997+A1:2001+A2:2002: Information technology equipment-Immunity characteristics-Limits and methods of measurement.

Standard	Description	Results	Criteria
EN 61000-4-2:2009 IEC 61000-4-2:2008	Electrostatic Discharge	Pass	B
EN 61000-4-3:2006+A1:2008 IEC 61000-4-3:2006+A1:2007	Radio-Frequency, Electromagnetic Field	Pass	A
EN 61000-4-4: 2004 +A1:2010 IEC 61000-4-4: 2004 +A1:2010	Electrical Fast Transient/Burst	Pass	B
EN 61000-4-5: 2006 IEC 61000-4-5: 2005	Surge	Pass	B
EN 61000-4-6:2009 IEC 61000-4-6:2008	Conductive Disturbance	Pass	A
EN 61000-4-8: 1993+A1: 2001 IEC 61000-4-8: 1993+A1: 2000	Power Frequency Magnetic Field	Pass	A
EN 61000-4-11: 2004 IEC 61000-4-11: 2004	Voltage Dips / Short Interruption and Voltage Variation		
	>95% in 0.5 period	Pass	B
	30% in 25 period	Pass	C
	>95% in 250 period	Pass	C

Standard	Description	Results
EN 61000-3-2: 2006 IEC 61000-3-2: 2005	Limits for harmonics current emissions	Pass
EN 61000-3-3: 2008 IEC 61000-3-3: 2008	Limits for voltage fluctuations and flicker in low-voltage supply systems.	Pass

### 1.3 Description of EUT

## EUT

Description:	Network Attached Storage
Condition:	Pre-Production
Model:	TS-879U-RP; TS-EC879U-RP; TS-879U-RP+; TS-EC879U-RP+; TS-879U II-RP; TS-EC879U II-RP; NAS-879UG-RP; NAS-EC879UG-RP; NAS-879UG-RP+; NAS-EC879UG-RP+; NAS-879UG II-RP; NAS-EC879UG II-RP; NSS508R; VS-8040U-RP Pro; VS-8032U-RP Pro; VS-8024U-RP Pro; NVR-8040U-RP Pro; NVR-8032U-RP Pro; NVR-8024U-RP Pro; NVR-8040UG-RP Pro; NVR-8032UG-RP Pro; NVR-8024UG-RP Pro; VS-8000U-RP Pro;NVR-8000U-RP Pro; NVR-8000UG-RP Pro; VS-8056U-RP Pro; VS-8048U-RP Pro; NVR-8056U-RP Pro; NVR-8048U-RP Pro; NVR-8056UG-RP Pro; NVR-8048UG-RP Pro
Serial Number:	N/A
Power Supply Type:	one- LEMACS (Model: R1S2-5300V4V) AC Input:100-240V~ 47-63Hz~4.5-2A DC Output: +5V 0-20A +12V 24A +3.3V 0-20A -12V 0-0.5A +5V 0-2.5A +5V AND +3.3V TOTAL MAX:140W Total output wattage: 300W MAX. Included:LEMACS (Model: P1S-2300V-R)*2 AC Input: 100-240V~ 47-63Hz~4.5-2A DC Output: +12V 24A +5V 0-2.5A Total output wattage: 300W MAX
CPU:	Intel® Core™ i3 2120 3.3GHz
DIMM Memory:	ADATA (Model: HY03I1B09C0ZS) 2GB DDR3-1333MHz
Power Switch Button:	one
USB 2.0 Port:	four (4-pins)
USB 3.0 Port:	two (9-pins)
E-Serial ATA Port:	two (7-pins)
RJ45 Connector:	two (8-pins) (10/100/1000Mbps)
Hard Disk:	Western Digital (Model: WD5000AADS-00S9B0)*8 500GB
Highest frequency of the internal sources of the EUT is 3.3GHz	

**All types of EUT Connect have been tested. The worst data listed in this test report.**

**Test Configuration:**

EUT + WD(Model: WD5000AADS-00S9B0)\*8 + External HDD (A-TEC Model: OT-201)\*4 + Drive Station USB3.0 Hard Drive(BUFFALO Model: BUF-HD-HXU3(B))\*2 + E-SATA External HDD (NexStar Model: NST-200SU-BK)\*2 + Power Supply (LEMACS Model: R1S2-5300V4V) + LCD Monitor (View Sonic Model: VA703B) + LAN (1000Mbps)\*2

**EMI Noise Source**

Crystal:25MHz (Y1), 25MHz (Y2), 24MHz (Y3), 25MHz (Y6), 25MHz (Y7),  
25MHz (Y8), 32.768KHz (X1), 25MHz (X2), 12MHz (Y1), 25MHz (U20),

**EMI Solution:**

N/A

**Model Different:**

Model	Package	Selling markets
TS-879U-RP	QNAP Brown Box	General storage related products supply chain management
TS-EC879U-RP	QNAP Brown Box	General storage related products supply chain management
TS-879U-RP+	QNAP Brown Box	Professional storage related products supply chain management
TS-EC879U-RP+	QNAP Brown Box	Professional storage related products supply chain management
TS-879U II-RP	QNAP Brown Box	Commercial/ Professional storage related products supply chain management
TS-EC879U II-RP	QNAP Brown Box	Commercial/ Professional storage related products supply chain management
NAS-879UG-RP	Brown Box (No QNAP Logo)	General Storage equipment Tender and Cooperation plan
NAS-EC879UG-RP	Brown Box (No QNAP Logo)	General Storage equipment Tender and Cooperation plan
NAS-879UG-RP+	Brown Box (No QNAP Logo)	Professional Storage equipment Tender and Cooperation plan
NAS-EC879UG-RP+	Brown Box (No QNAP Logo)	Professional Storage equipment Tender and Cooperation plan
NAS-879UG II-RP	Brown Box (No QNAP Logo)	Commercial/ Professional Storage equipment Tender and Cooperation plan
NAS-EC879UG II-RP	Brown Box (No QNAP Logo)	Commercial/ Professional Storage equipment Tender and Cooperation plan
NSS508R	Cisco Brown Box (Cisco Logo)	Commercial/ Professional Storage equipment Tender and Cooperation plan
VS-8040U-RP Pro	Carton Box	Large video storage related products supply chain management
VS-8032U-RP Pro	Carton Box	Industrial Monitor storage related products supply chain management
VS-8024U-RP Pro	Carton Box	Professional Monitor storage related products supply chain management

Model	Package	Selling markets
NVR-8040U-RP Pro	Carton Box	Large Monitor storage Tender product
NVR-8032U-RP Pro	Carton Box	Industrial Monitor storage Tender product
NVR-8024U-RP Pro	Carton Box	Professional Monitor storage Tender product
NVR-8040UG-RP Pro	Carton Box (No QNAP Logo)	Large video Image storage Cooperation plan
NVR-8032UG-RP Pro	Carton Box (No QNAP Logo)	Industrial Image storage Cooperation plan
NVR-8024UG-RP Pro	Carton Box (No QNAP Logo)	Professional Image storage Cooperation plan
VS-8000U-RP Pro	Carton Box	General Professional Monitor storage related products supply chain management
NVR-8000U-RP Pro	Carton Box	General Professional Monitor storage Tender product
NVR-8000UG-RP Pro	Carton Box (No QNAP Logo)	General Professional Image storage Cooperation plan
VS-8056U-RP Pro	Carton Box	Large video storage related products supply chain management
VS-8048U-RP Pro	Carton Box	Industrial Monitor storage related products supply chain management
NVR-8056U-RP Pro	Carton Box	Large Monitor storage Tender product
NVR-8048U-RP Pro	Carton Box	Industrial Monitor storage Tender product
NVR-8056UG-RP Pro	Carton Box (No QNAP Logo)	Large video Image storage Cooperation plan
NVR-8048UG-RP Pro	Carton Box (No QNAP Logo)	Industrial Image storage Cooperation plan

#### 1.4 Description of Support Equipment

Unit	Model Serial No.	Brand	Power Cord	FCC ID
Notebook Personal Computer	Latitude D400 S/N: N/A	DELL	Non-shielded, Detachable	FCC DOC
17" LCD Monitor	VA703B	View Sonic	Non-shielded, Detachable	FCC DOC
External HDD Enclosure*4	OT-201 S/N: N/A	A-TEC	N/A	FCC DOC
Drive Station USB3.0 Hard Drive*2	BUF-HD-HXU3(B) S/N:15564800202599	BUFFALO	Non-shielded, Detachable	FCC DOC
E-SATA External Hard Disk*2	NST-200SU-BK S/N: N/A	NexStar	Non-shielded, Detachable	FCC DOC
Rack mountable Switch	DGS-1008D	D-Link	D-Link (Model:AF-1205-B )	FCC DOC



### 1.5 Software for Controlling Support Unit

Test programs exercising various part of EUT were used. The programs were executed as follows:

- A. Send EUT information to the video port device (Monitor).
- B. Receive and transmit package of EUT to the Rack mountable Switch HUB through LAN port.
- C. Read and write data in the E-SATA Hard Disk through EUT E-SATA port.
- D. R/W External HDD Enclosure from USB Port.
- E. Used Tfggen.exe to Send signal to EUT RJ45 port through PC RJ45 Port.
- F. Search External HDD from Notebook RJ45 to EUT RJ45 with InterEMC.exe.
- G. Repeat the above steps.

	Filename	Issued Date
External Hard Disk	InterEMC.exe	04/16/2003
E-SATA	Intel EMC.exe	04/16/2003
<u>Rack mountable Switch</u>	ping.exe	05/05/1999
EUT Hard Disk	InterEMC.exe	04/16/2003
RJ45	Tfggen.exe	05/22/2001

### 1.6 I/O Cable Condition of EUT and Support Units

Description	Path	Cable Length	Cable Type	Connector Type
AC Power Cord	110V (~240V) to EUT SPS	1.8M	Non-shielded, Detachable	Plastic Head
USB Data Cable*4	External HDD Enclosure USB Port to EUT USB Port	0.98M	Non-shielded, Detachable (With Core)	Metal Head
USB 3.0 Data Cable*2	Drive Station USB3.0 Hard Drive USB port to EUT USB 3.0 port	1.0M	shielded, Detachable	Metal Head
E-SATA Data Cable*2	External Hard disk E-SATA Port to EUT E-SATA Port	1.0M	Non-Shielded, Detachable	Metal Head
LAN Data Cable	NB LAN Port to Switch HUB LAN Port.	33 feet	Non-shielded, Detachable	Plastic Head
LAN Data Cable*2	EUT LAN Port to Switch HUB LAN Port	10M	Non-shielded, Detachable	Plastic Head
LCD Monitor Data Cable	LCD Monitor D-Sub Port to EUT D-Sub Port	1.98M	Non-Shielded, Detachable	Metal Head

## 2. Power Main Port Conducted Emissions

### 2.1 Test Setup and Procedure

#### 2.1.1 Test Setup

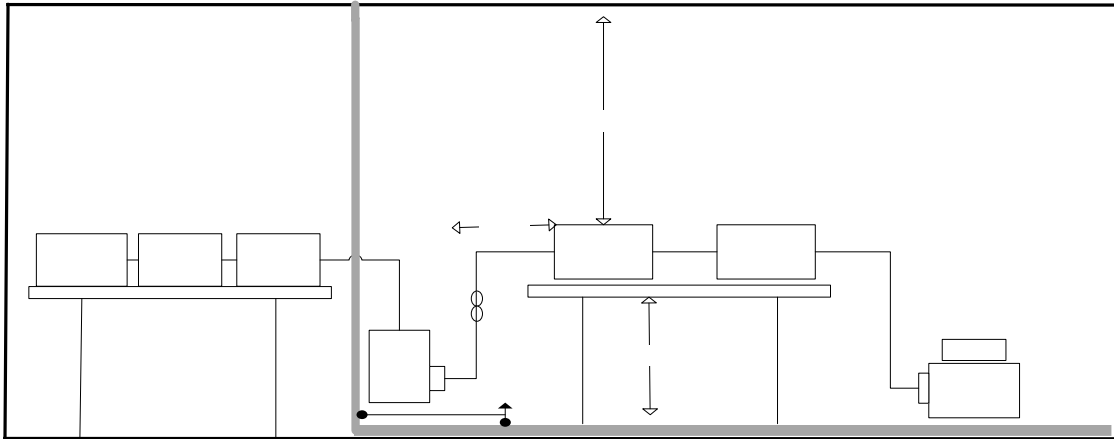

#### 2.1.2 Test Procedure

The measurements are performed in a 3.5m x 3.4m x 2.5m shielded room, which referred as Conduction 01 test site, or a 3m x 3m x 2.3m test site, which referred as Conduction 02 test site. The EUT was placed on non-conduction 1.0m x 1.5m table, which is 0.8 meters above an earth-grounded.

Power to the EUT was provided through the LISN which has the Impedance (50ohm/50uH) vs. Frequency Characteristic in accordance with the standard. Power to the LISNs were filtered to eliminate ambient signal interference and these filters were bonded to the ground plane. Peripheral equipment required to provide a functional system (support equipment) for EUT testing was powered from the second LISN through a ganged, metal power outlet box which is bonded to the ground plane at the LISN. Printer Control Receiver PC

The interconnecting cables were arranged and moved to get the maximum measurement. Both the line of power cord, hot and neutral, were measured.

The highest emissions were analyzed in details by operating the spectrum analyzer in fixed tuned mode to determine the nature of the emissions and to provide information which could be useful in reducing their amplitude.

#### 2.1.3 EMI Receiver/Spectrum Analyzer Configuration (for the frequencies tested)

Frequency Range:	150KHz--30MHz
Detector Function:	Quasi-Peak / Average Mode
Resolution Bandwidth:	9KHz

## 2.2 Conduction Test Data: Configuration 1

### Table 2.2.1 Power Line Conducted Emissions (Hot)

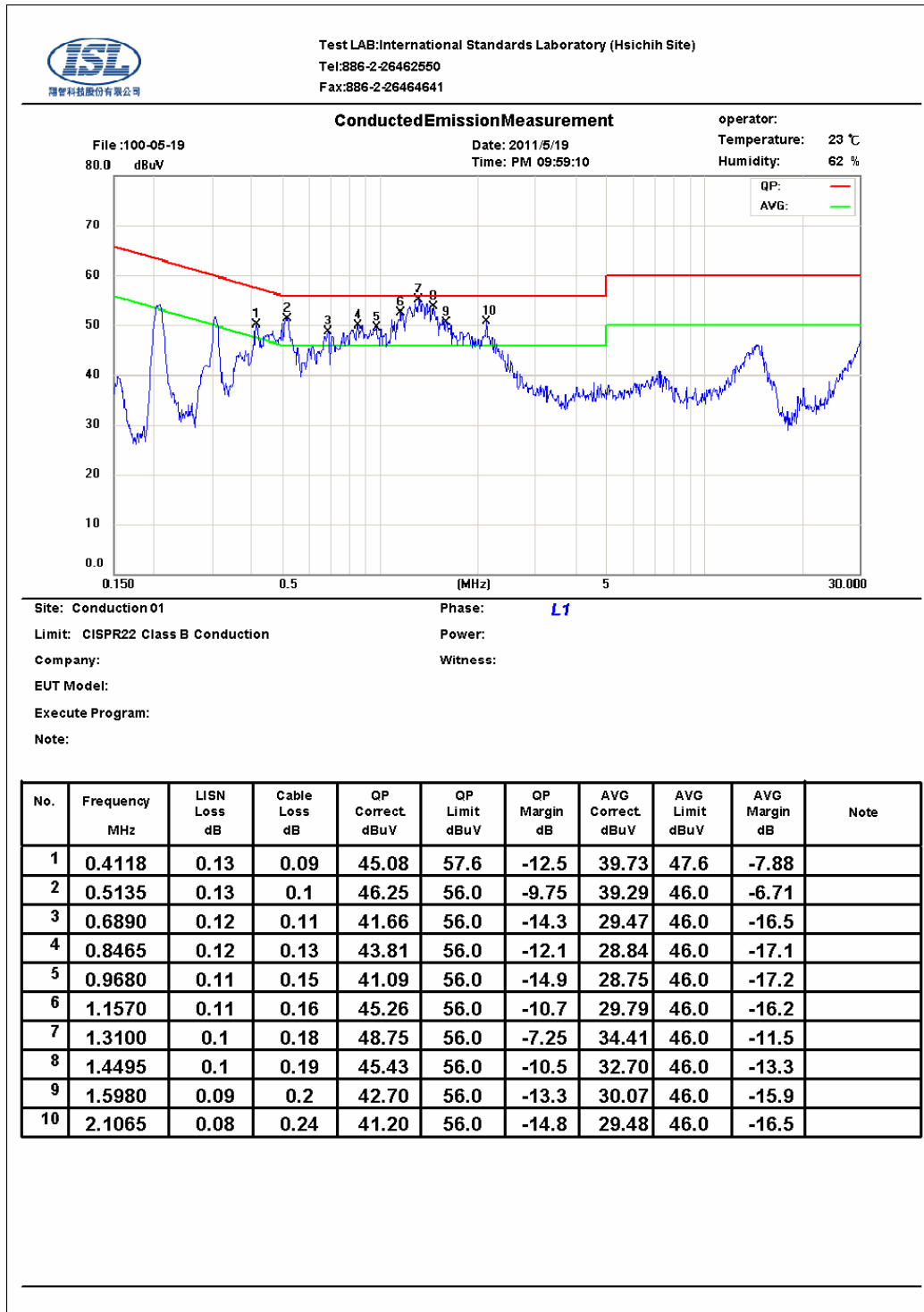

Note:

Margin = Corrected Amplitude - Limit

Corrected Amplitude = Receiver Reading + LISN Loss + Cable Loss

A margin of -8dB means that the emission is 8dB below the limit

The frequency spectrum graph is for final peak graph, and the attached table is for QP/AVG test result.

If peak data can pass, it will be shown in "QP/AVG Correct" column, if not, QP/AVG data will instead.

**Table 2.2.2 Power Line Conducted Emissions (Neutral)**



Note:

Margin = Corrected Amplitude - Limit

Corrected Amplitude = Receiver Reading + LISN Loss + Cable Loss

A margin of -8dB means that the emission is 8dB below the limit

**The frequency spectrum graph is for final peak graph, and the attached table is for QP/AVG test result.**

**If peak data can pass, it will be shown in "QP/AVG Correct" column, if not, QP/AVG data will instead.**

### 3. Telecommunication Port Conducted Emissions

#### 3.1 Test Setup and Procedure

##### 3.1.1 Test Setup

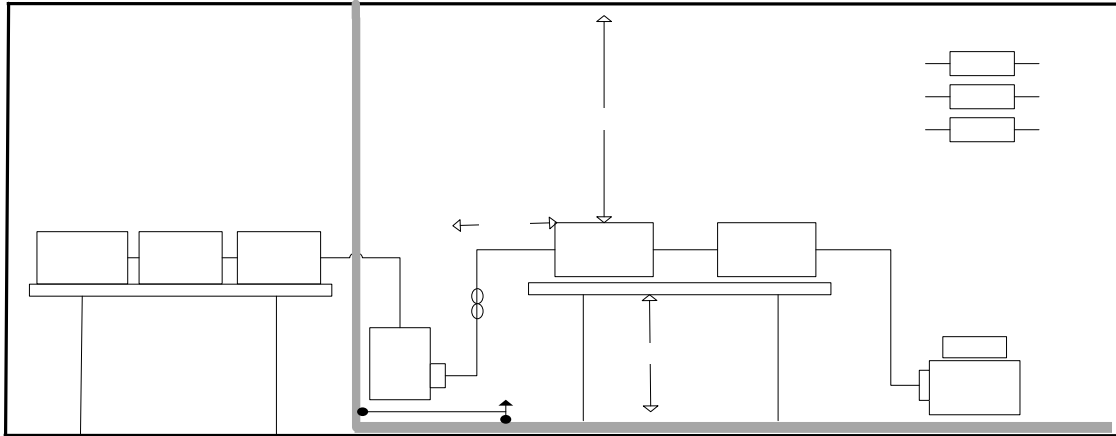

Shield

##### 3.1.2 Test Procedure

The measurements are performed in a 3.5m x 3.4m x 2.5m shielded room, which referred as Conduction 01 test site, or a 3m x 3m x 2.3m test site, which referred as Conduction 02 test site. The EUT was placed on non-conduction 1.0m x 1.5m table, which is 0.8 meters above an earth-grounded.

The EUT, any support equipment, and any interconnecting cables were arranged and moved to get the maximum measurement.

Power to the EUT was provided through the LISN which has the Impedance (50 Ohm/50uH) vs. Frequency Characteristic in accordance with the standard. Power to the LISN was filtered to eliminate ambient signal interference and this filter was bonded to ground. Peripheral equipment to provide a functional system (support equipment) for EUT testing was powered through a ganged, metal power outlet box bonded to the ground. AC input power for the auxiliary power outlets was obtained from the same filtered source that provides input power to the LISN.

The highest emissions were analyzed in details by operating the spectrum analyzer in fixed tuned mode to determine the nature of the emissions and to provide information could be useful in reducing their amplitude.

##### 3.1.3 EMI Receiver/Spectrum Analyzer Configuration (for the frequencies tested)

Frequency Range:	150KHz--30MHz
Detector Function:	Quasi-Peak / Average Mode
Resolution Bandwidth:	9KHz

EUT  
LISN  
Metal Ground Plane



### 3.3 Test Data: LAN--100M: Configuration 1

Table 3.3.1 Telecommunication Port Conducted Emission

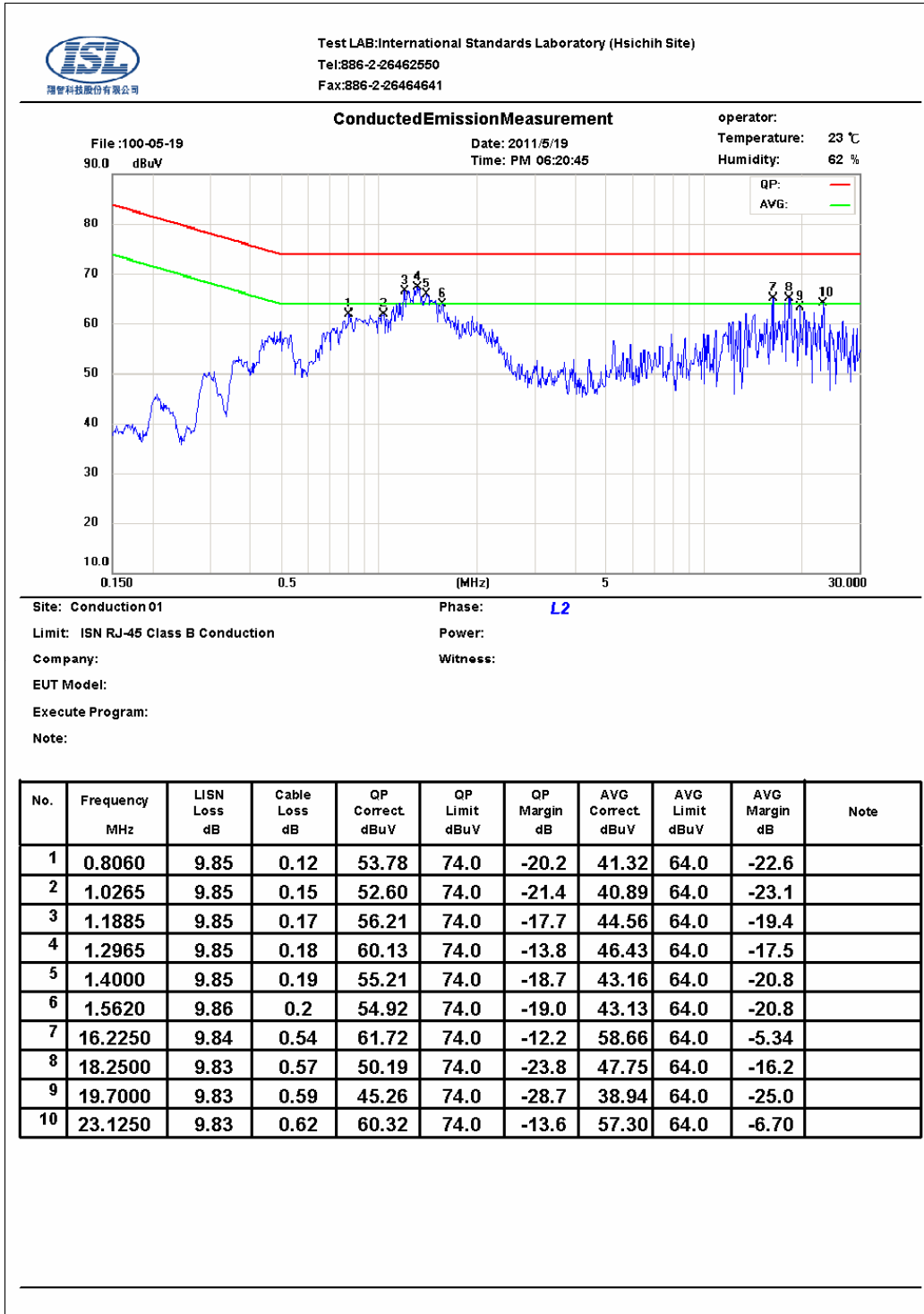

**Note :**

Margin = Corrected Amplitude - Limit

Corrected Amplitude = Receiver Reading + LISN Loss + Cable Loss

A margin of -8dB means that the emission is 8dB below the limit

The frequency spectrum graph is for final peak graph, and the attached table is for QP/AVG test result.

If peak data can pass, it will be shown in "QP/AVG Correct" column, if not, QP/AVG data will instead.





### 3.5 Test Data: LAN--10M: Configuration 2

Table 3.5.1 Telecommunication Port Conducted Emission

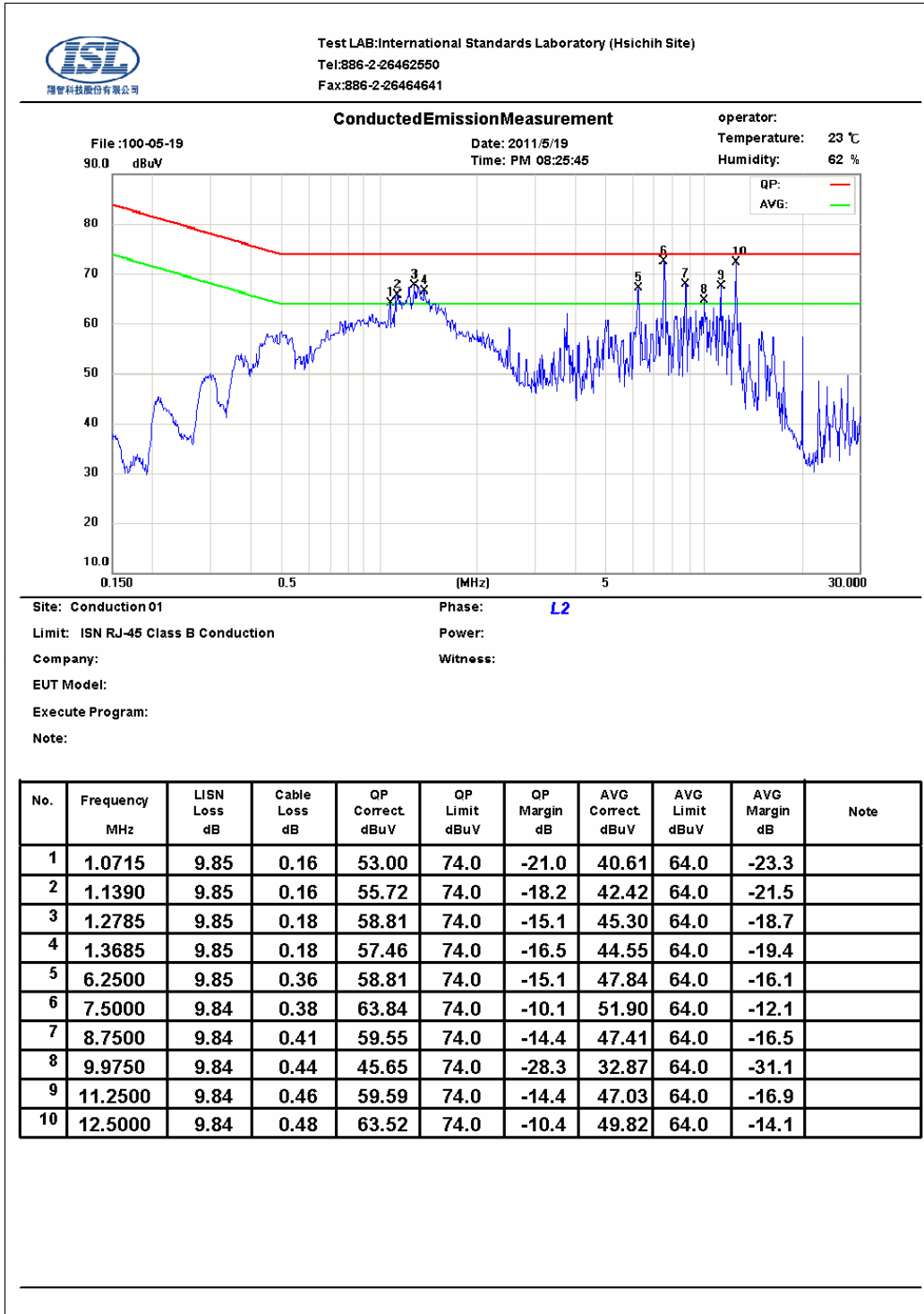

**Note :**

Margin = Corrected Amplitude - Limit

Corrected Amplitude = Receiver Reading + LISN Loss + Cable Loss

A margin of -8dB means that the emission is 8dB below the limit

The frequency spectrum graph is for final peak graph, and the attached table is for QP/AVG test result.

If peak data can pass, it will be shown in "QP/AVG Correct" column, if not, QP/AVG data will instead.



### 3.7 Test Data: LAN--GIGA: Configuration 2

Table 3.7.1 Telecommunication Port Conducted Emission

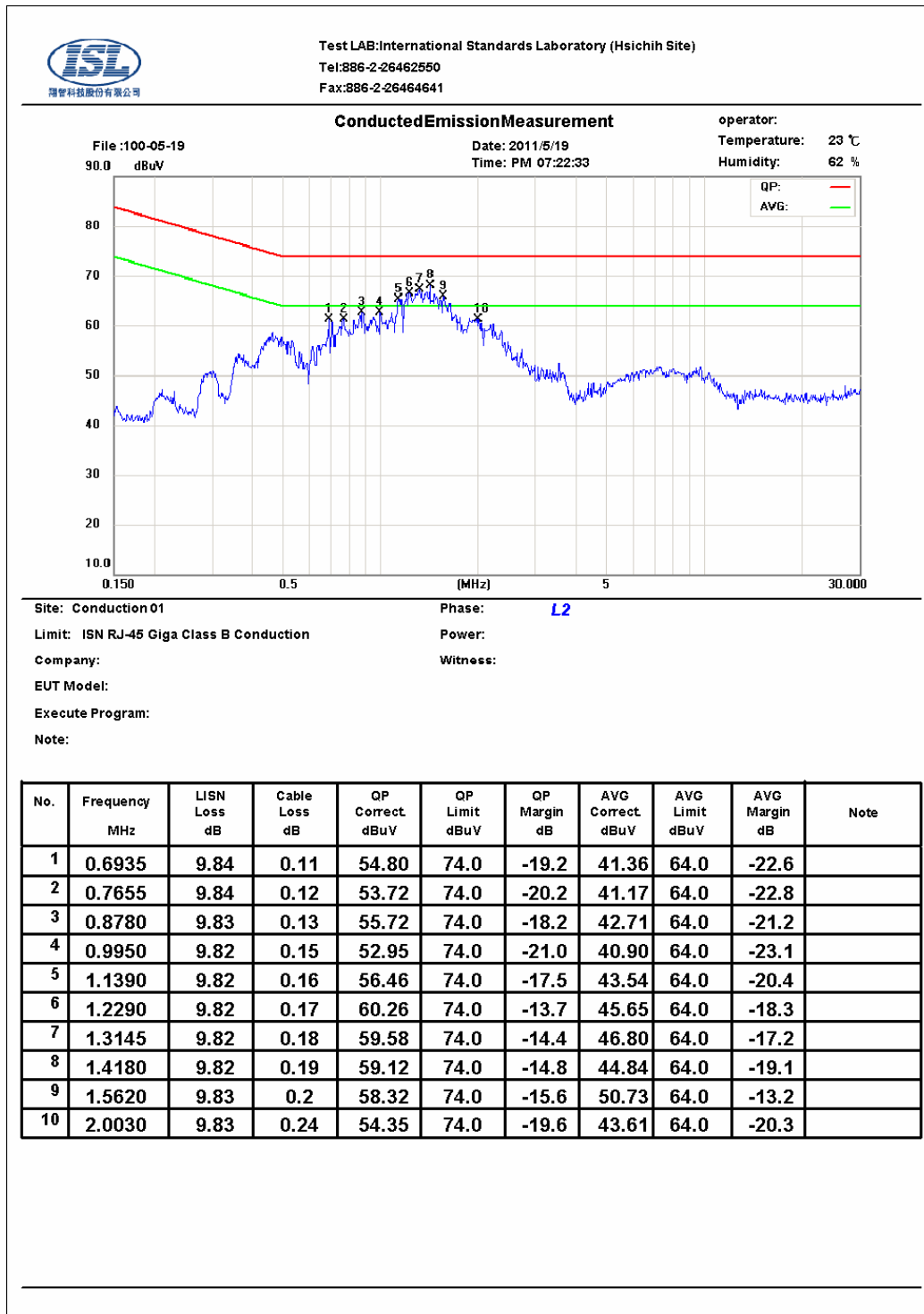

**Note :**

Margin = Corrected Amplitude - Limit

Corrected Amplitude = Receiver Reading + LISN Loss + Cable Loss

A margin of -8dB means that the emission is 8dB below the limit

The frequency spectrum graph is for final peak graph, and the attached table is for QP/AVG test result.

If peak data can pass, it will be shown in "QP/AVG Correct" column, if not, QP/AVG data will instead.

## 4. Radiated Disturbance Emissions

### 4.1 Test Setup and Procedure

#### 4.1.1 Test Setup

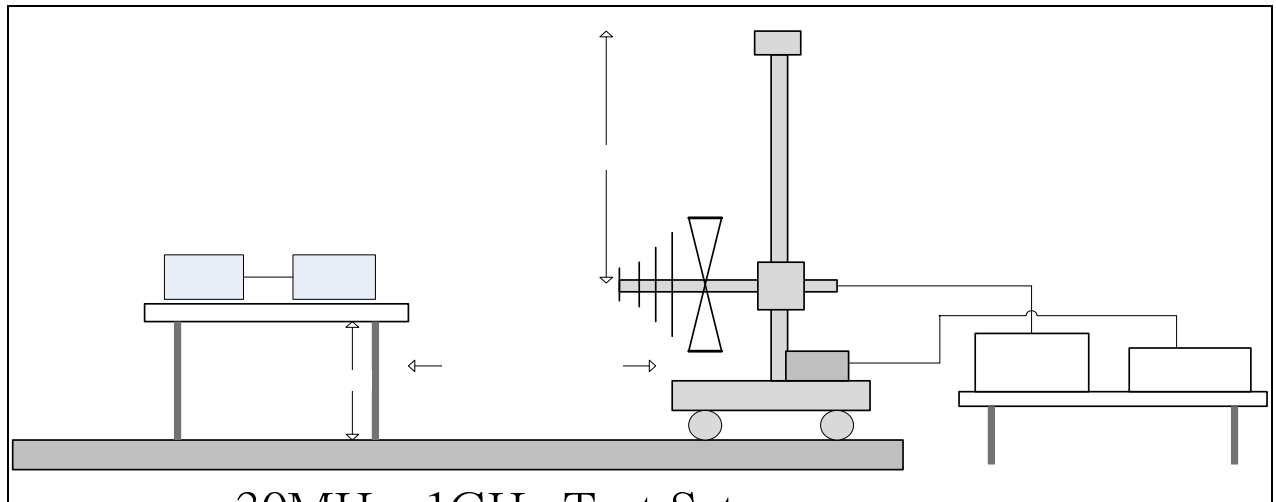

30MHz~1GHz Test Setup

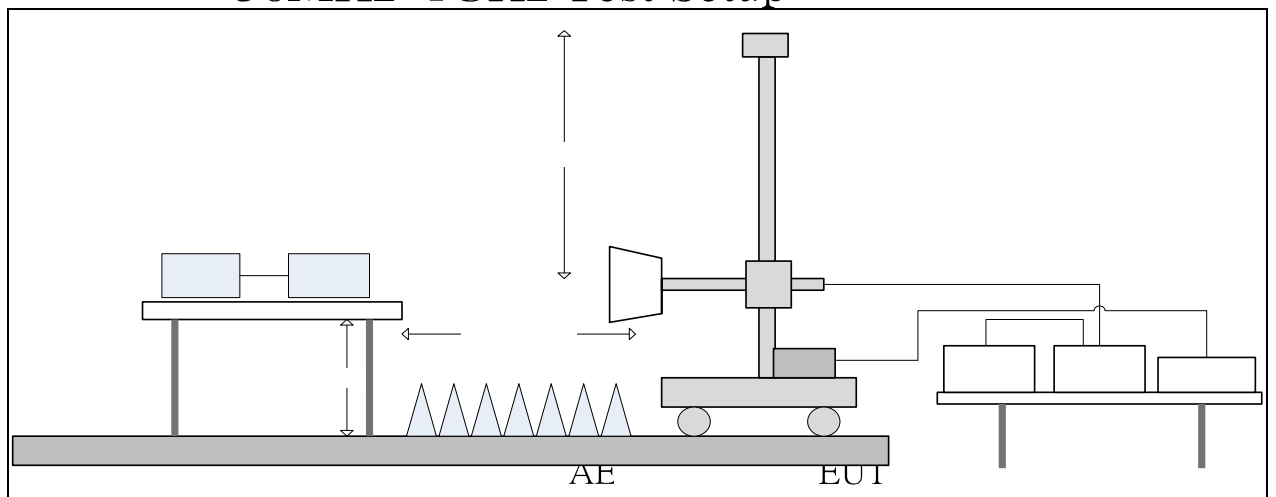

1m to

#### 4.1.2 Test Procedure

The radiated emissions test will then be repeated on the open site or chamber to measure the amplitudes accurately and without the multiple reflections existing in the shielded room. The EUT and support equipment are set up on the turntable of one of 10 meter open field sites or 10 meter chamber. Desktop EUT are set up on a wooden stand and 0.8 meter above the ground or floor-standing arrangement shall be placed on the horizontal ground reference plane. The test volume for a height of up to 30 cm may be obstructed by absorber placed on the ground plane.

For the initial measurements, the receiving antenna is varied from 1.4 meter height and is changed in the vertical plane from vertical to horizontal polarization at each frequency. The highest emissions between 30 MHz to 1000 MHz were analyzed in details by operating the spectrum analyzer and/or EMI receiver in quasi-peak mode to determine the precise amplitude of the emissions. The highest emissions between 1GHz to 6GHz were analyzed in details by operating

the spectrum analyzer in peak and average mode to determine the precise amplitude of the emissions.

At the highest amplitudes observed, the EUT is rotated in the horizontal plane while changing the antenna polarization in the vertical plane to maximize the reading. The interconnecting cables were arranged and moved to get the maximum measurement. Once the maximum reading is obtained, the antenna elevation and polarization will be varied between specified limits to maximize the readings.

The highest internal source of an EUT is defined as the highest frequency generated or used within the EUT or on which the EUT operates or tunes. If the highest frequency of the internal sources of the EUT is less than 108 MHz, the measurement shall only be made up to 1 GHz. If the highest frequency of the internal sources of the EUT is between 108 MHz and 500 MHz, the measurement shall only be made up to 2 GHz. If the highest frequency of the internal sources of the EUT is between 500 MHz and 1 GHz, the measurement shall only be made up to 5 GHz. If the highest frequency of the internal sources of the EUT is above 1 GHz, the measurement shall be made up to 5 times the highest frequency or 6 GHz, whichever is less.

#### 4.1.3 Spectrum Analyzer Configuration (for the frequencies tested)

Frequency Range:	30MHz--1000MHz
Detector Function:	Quasi-Peak Mode
Resolution Bandwidth:	120KHz
Frequency Range:	Above 1 GHz to 6 GHz
Detector Function:	Peak/Average Mode
Resolution Bandwidth:	1MHz

## 4.2 Radiation Test Data: Configuration 1

### Table 4.2.1 Radiated Emissions (Horizontal)

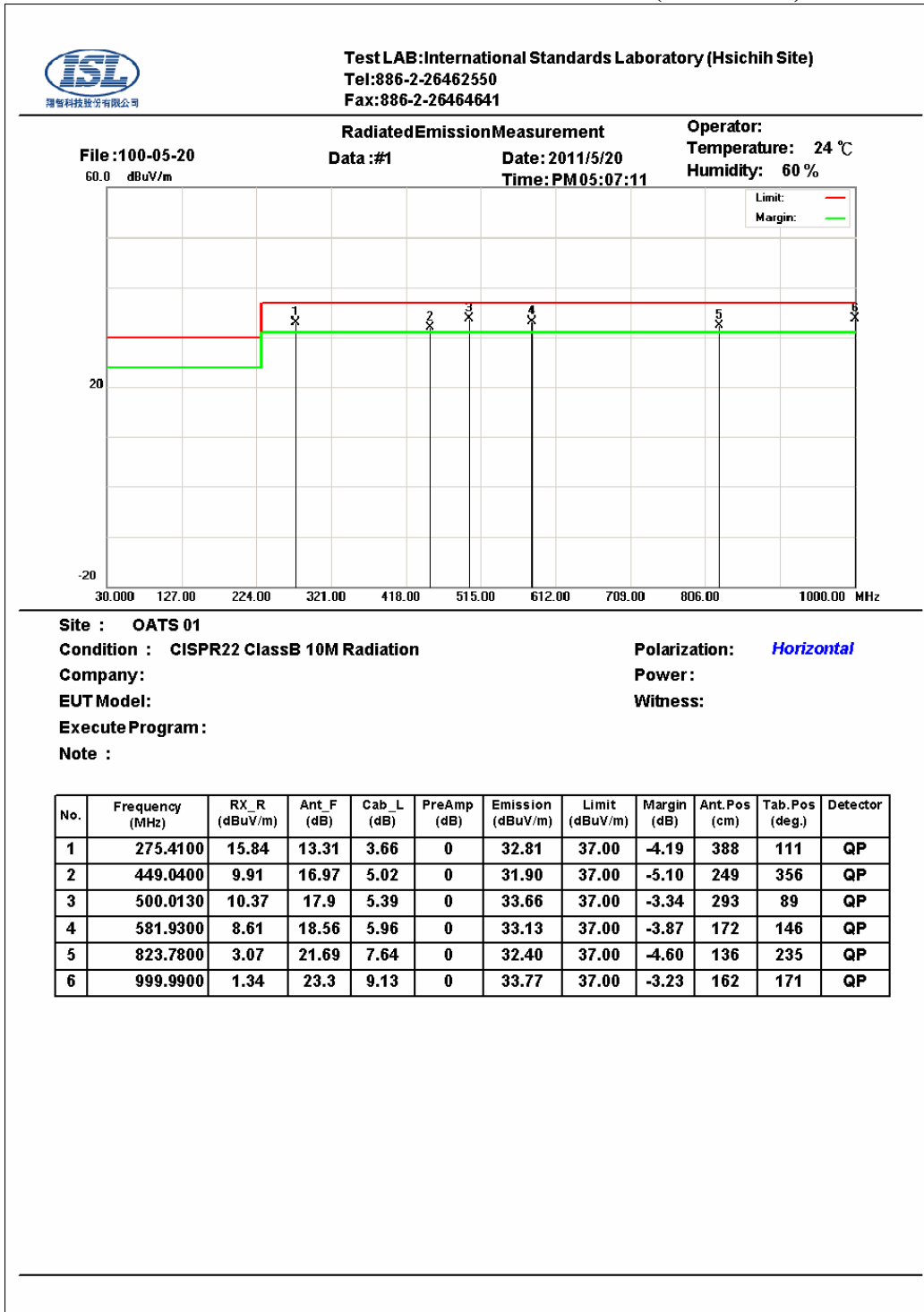

\* Note:

Margin = Corrected Amplitude – Limit

Corrected Amplitude = Radiated Amplitude + Antenna Correction Factor + Cable Loss – Pre-Amplifier Gain

A margin of -8dB means that the emission is 8dB below the limit

BILOG Antenna Distance: 10 meters

Below 1GHz test, if the peak measured value meets the QP limit, it is unnecessary to perform the QP measurement.



Address: No.120, Lane 180, San Ho Tsuen, Hsin Ho Road  
Lung-Tan Hsiang, Tao Yuan Conty, Taiwan R.O.C.  
Tel: 03-4071718

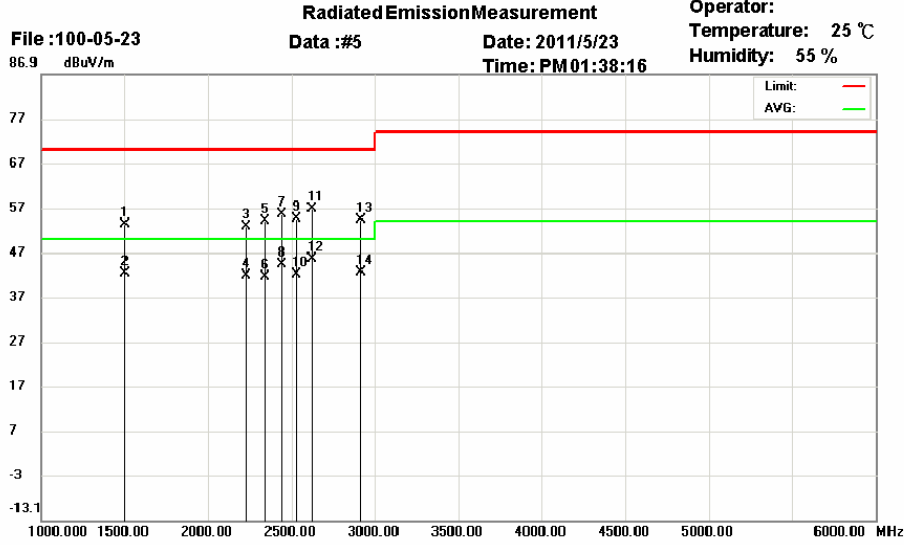

Site : **Chamber 14**  
Condition : **CISPR22 ClassB Radiation(Peak)**  
Company :  
EUT Model :  
Execute Program :  
Note :

Polarization: **Horizontal**  
Power :  
Witness:

Mk.	Frequency (MHz)	RX_R (dBuV/m)	Ant_F (dB)	Cab_L (dB)	PreAmp (dB)	Emission (dBuV/m)	Limit (dBuV/m)	Margin (dB)	Ant.Pos (cm)	Tab.Pos (deg.)	Detector
1	1500.200	69.11	28.6	1.79	46.3	53.20	70.00	-16.80	142	297	peak
2	1500.200	58.28	28.6	1.79	46.3	42.37	50.00	-7.63	142	297	AVG
3	2227.900	64.51	32.51	2.22	46.45	52.79	70.00	-17.21	100	116	peak
4	2227.900	53.60	32.51	2.22	46.45	41.88	50.00	-8.12	100	116	AVG
5	2343.400	65.48	32.72	2.28	46.47	54.01	70.00	-15.99	172	149	peak
6	2343.400	52.92	32.72	2.28	46.47	41.45	50.00	-8.55	172	149	AVG
7	2439.000	66.83	32.89	2.34	46.49	55.57	70.00	-14.43	187	28	peak
8	2439.000	55.59	32.89	2.34	46.49	44.33	50.00	-5.67	187	28	AVG
9	2527.300	65.55	33.03	2.38	46.51	54.45	70.00	-15.55	187	28	peak
10	2527.300	53.11	33.03	2.38	46.51	42.01	50.00	-7.99	187	28	AVG
11	2617.600	67.69	33.14	2.43	46.52	56.74	70.00	-13.26	187	28	peak
12	2617.600	56.49	33.14	2.43	46.52	45.54	50.00	-4.46	187	28	AVG
13	2913.200	64.79	33.5	2.58	46.58	54.29	70.00	-15.71	187	58	peak
14	2913.200	53.06	33.5	2.58	46.58	42.56	50.00	-7.44	187	58	AVG

\*:Maximum data    x:Over limit    !:over margin

\* Note:  
Margin = Corrected Amplitude – Limit  
Corrected Amplitude = Radiated Amplitude + Antenna Correction Factor + Cable Loss – Pre-Amplifier Gain  
A margin of -8dB means that the emission is 8dB below the limit  
Horn Antenna      Distance: 3 meters

Above 1GHz test, if the peak measured value meets the average limit, it is unnecessary to perform the average measurement.



**Table 4.2.2 Radiated Emissions (Vertical)**

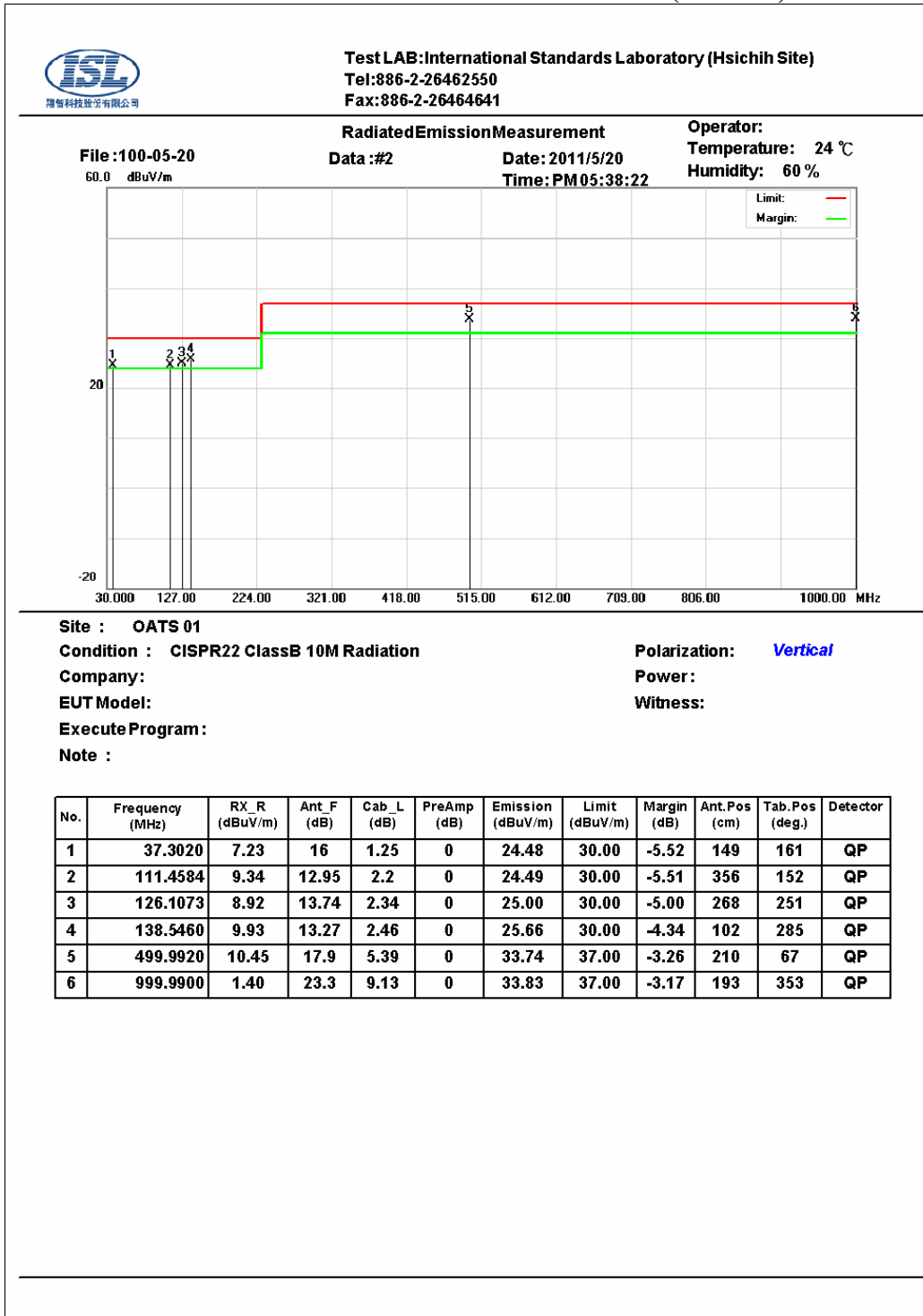

\* Note:

Margin = Corrected Amplitude – Limit

Corrected Amplitude = Radiated Amplitude + Antenna Correction Factor + Cable Loss – Pre-Amplifier Gain

A margin of -8dB means that the emission is 8dB below the limit

BILOG Antenna Distance: 10 meters

**Below 1GHz test, if the peak measured value meets the QP limit, it is unnecessary to perform the QP measurement.**



Address: No.120, Lane 180, San Ho Tsuen, Hsin Ho Road  
Lung-Tan Hsiang, Tao Yuan Conty, Taiwan R.O.C.  
Tel: 03-4071718

**Radiated Emission Measurement**  
 File : 100-05-23      Data : #6      Date : 2011/5/23      Operator :  
 86.9 dBuV/m      Time : PM02:10:54      Humidity : 25 °C  
 Humidity : 55 %

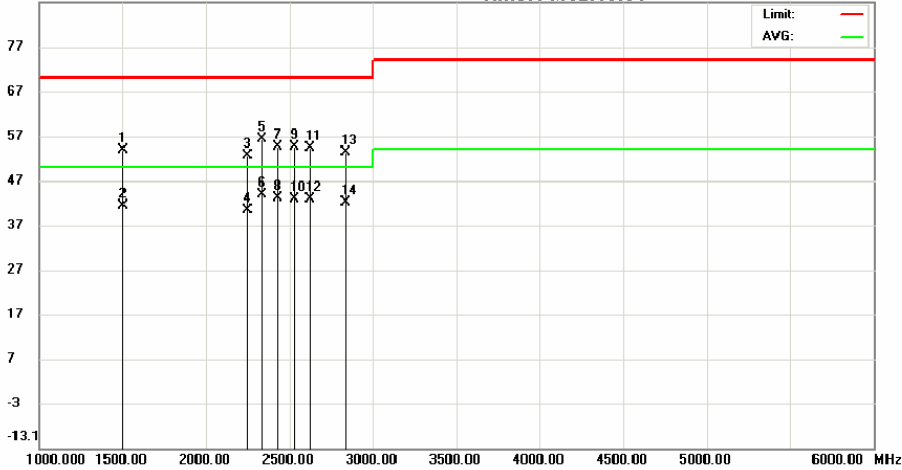

Site : Chamber 14  
 Condition : CISPR22 ClassB Radiation(Peak)      Polarization: Vertical  
 Company:  
 EUT Model:      Power :  
 Execute Program :      Witness:  
 Note :

Mk.	Frequency (MHz)	RX_R (dBuV/m)	Ant_F (dB)	Cab_L (dB)	PreAmp (dB)	Emission (dBuV/m)	Limit (dBuV/m)	Margin (dB)	Ant.Pos (cm)	Tab.Pos (deg.)	Detector
1	1500.280	69.62	28.6	1.79	46.3	53.71	70.00	-16.29	202	14	peak
2	1500.280	57.26	28.6	1.79	46.3	41.35	50.00	-8.65	202	14	AVG
3	2245.500	64.09	32.54	2.23	46.45	52.41	70.00	-17.59	202	40	peak
4	2245.500	52.06	32.54	2.23	46.45	40.38	50.00	-9.62	202	40	AVG
5	2333.400	67.76	32.7	2.28	46.47	56.27	70.00	-13.73	100	357	peak
6	2333.400	55.24	32.7	2.28	46.47	43.75	50.00	-6.25	100	357	AVG
7	2427.900	65.88	32.87	2.33	46.49	54.59	70.00	-15.41	100	354	peak
8	2427.900	54.29	32.87	2.33	46.49	43.00	50.00	-7.00	100	354	AVG
9	2527.400	65.72	33.03	2.38	46.51	54.62	70.00	-15.38	100	335	peak
10	2527.400	54.00	33.03	2.38	46.51	42.90	50.00	-7.10	100	335	AVG
11	2617.800	65.33	33.14	2.43	46.52	54.38	70.00	-15.62	100	335	peak
12	2617.800	53.78	33.14	2.43	46.52	42.83	50.00	-7.17	100	335	AVG
13	2831.200	63.80	33.4	2.54	46.57	53.17	70.00	-16.83	142	360	peak
14	2831.200	52.59	33.4	2.54	46.57	41.96	50.00	-8.04	142	360	AVG

\*:Maximum data    x:Over limit    !:over margin

\* Note:

Margin = Corrected Amplitude – Limit

Corrected Amplitude = Radiated Amplitude + Antenna Correction Factor + Cable Loss – Pre-Amplifier Gain

A margin of -8dB means that the emission is 8dB below the limit

Horn Antenna      Distance: 3 meters

Above 1GHz test, if the peak measured value meets the average limit, it is unnecessary to perform the average measurement.

## 5. Electrostatic discharge (ESD) immunity

### 5.1 Electrostatic discharge (ESD) immunity test

Port:	Enclosure
Basic Standard:	EN 61000-4-2/ IEC EN61000-4-2 (details referred to Sec 1.2)
Test Level:	Air +/- 2 kV, +/- 4 kV, +/- 8 kV Contact +/- 2 kV, +/- 4 kV
Criteria:	B
Test Procedure	refer to ISL QA -T4-E-S7
Temperature:	24 °C
Humidity:	51%

#### Selected Test Point

**Air:** discharges were applied to slots, aperture or insulating surfaces. 10 single air discharges were applied to each selected points.

**Contact:** Total 200 discharges minimum were to the selected contact points.

**Indirect Contact Points:** 25 discharges were applied to center of one edge of VCP and each EUT side of HCP with 10 cm away from EUT.

For final test points, please refer to EUT 33 to EUT 34 of Appendix: Photographs of EUT. Red arrow lines indicate the contact points, and blue arrow lines indicate the air points.

#### Test Setup

EUT is 1m from the wall and other metallic structure. When Battery test mode is needed, a cable with one 470KΩ resistor at two rare ends is connected from metallic part of EUT and screwed to HCP.

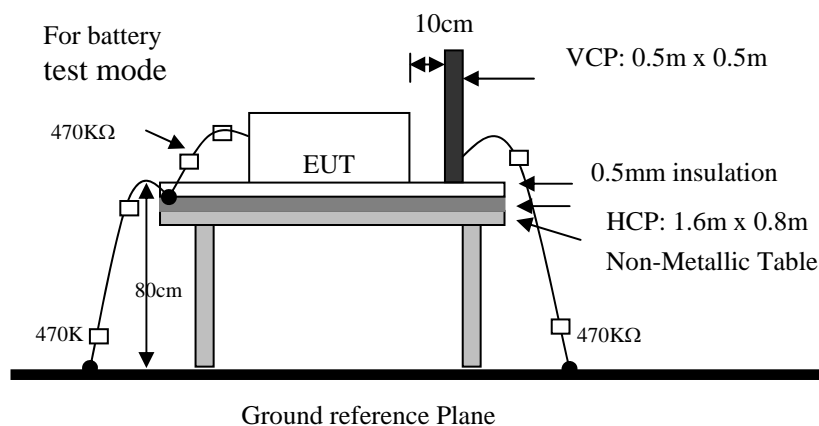

#### Test Result

**Performance of EUT complies with the given specification.**

## 6. Radio-Frequency, Electromagnetic Field immunity

### 6.1 Radio-Frequency, Electromagnetic Field immunity test

Port:	Enclosure
Basic Standard:	EN 61000-4-3/ IEC EN61000-4-3 (details referred to Sec 1.2)
Test Level::	3 V/m
Modulation:	AM 1KHz 80%
Frequency range:	80 MHz~1 GHz
Frequency Step:	1% of last step frequency
Dwell time:	3s
Polarization:	Vertical and Horizontal
EUT Azimuth Angle	☒0° ☒90° ☒180° ☒270°
Criteria:	A
Test Procedure	refer to ISL QA -T4-E-S8
Temperature:	25°C
Humidity:	58%

#### Test Setup

The field sensor is placed at one calibration grid point to check the intensity of the established fields on both polarizations. EUT is adjusted to have each side of EUT face coincident with the calibration plane. A CCD camera and speakers are used to monitor the condition of EUT for the performance judgment.

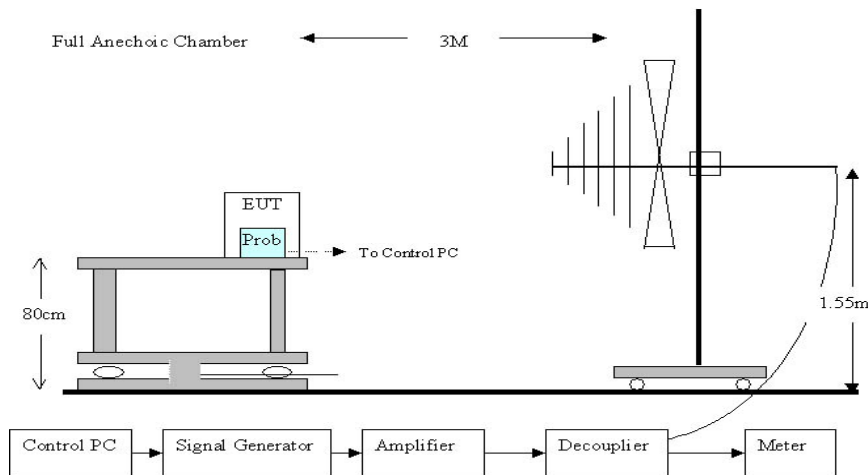

#### Test Result

**Performance of EUT complies with the given specification.**

## 7. Electrical Fast transients/burst immunity

### 7.1 Electrical Fast transient/burst immunity test

Port:	AC mains; Twisted Pair LAN Port
Basic Standard:	EN 61000-4-4/ IEC EN61000-4-4 (details referred to Sec 1.2)
Test Level:	<b>AC Power Port:</b> +/- 1 kV <b>Twisted Pair LAN Port (I/O Cables):</b> +/- 0.5 kV
Rise Time:	5ns
Hold Time:	50ns
Repetition Frequency:	5KHz
Criteria:	B
Test Procedure	refer to ISL QA -T4-E-S9
Temperature:	25 °C
Humidity:	59%

#### Test Procedure

The EUT was setup on a nonconductive table 0.1 m above a reference ground plane.

Test Points	Polarity	Result	Comment
Line	+	N	60 sec
	-	N	60 sec
Neutral	+	N	60 sec
	-	N	60 sec
Ground	+	N	60 sec
	-	N	60 sec
Line to Neutral	+	N	60 sec
	-	N	60 sec
Line to Ground	+	N	60 sec
	-	N	60 sec
Neutral to Ground	+	N	60 sec
	-	N	60 sec
Line to Neutral to Ground	+	N	60 sec
	-	N	60 sec
Capacitive coupling clamp	+	N	60 sec
	-	N	60 sec

**Note:** 'N' means normal, the EUT function is correct during the test.

## Test Setup

EUT is at least 50cm from the conductive structure.

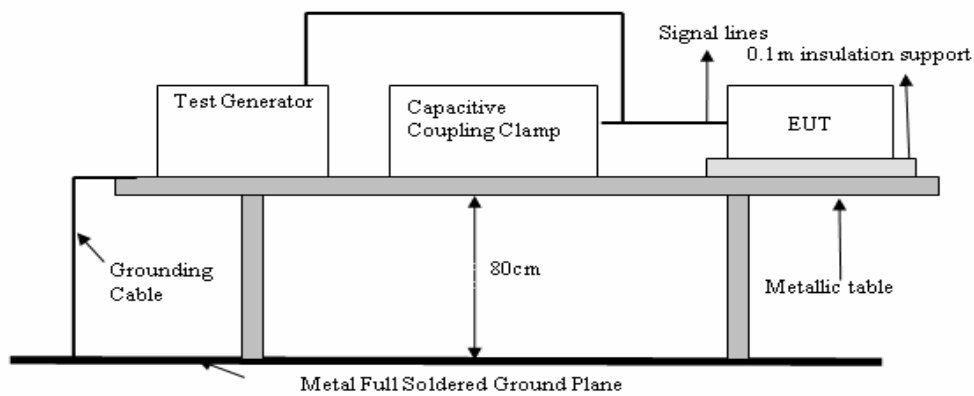
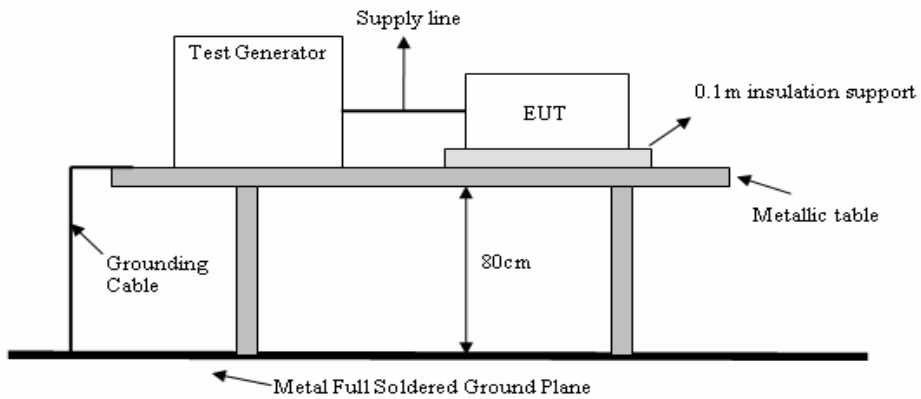

## Test Result

**Performance of EUT complies with the given specification.**

## 8. Surge Immunity

### 8.1 Surge immunity test

Port:	AC mains
Basic Standard:	EN 61000-4-5/ IEC EN61000-4-5 (details referred to Sec 1.2)
Test Level:	<b>AC Power Port:</b> Line to Line: +/- 0.5 kV, +/- 1 kV Line to Earth: +/- 0.5 kV, +/- 1 kV, +/- 2kV
Rise Time:	1.2us
Hold Time:	50us
Repetition Rate:	30 second
Angle:	☒0° ☒90° ☒180° ☒270°
Criteria:	B
Test Procedure	refer to ISL QA -T4-E-S10
Temperature:	25°C
Humidity:	59%

#### Test Setup

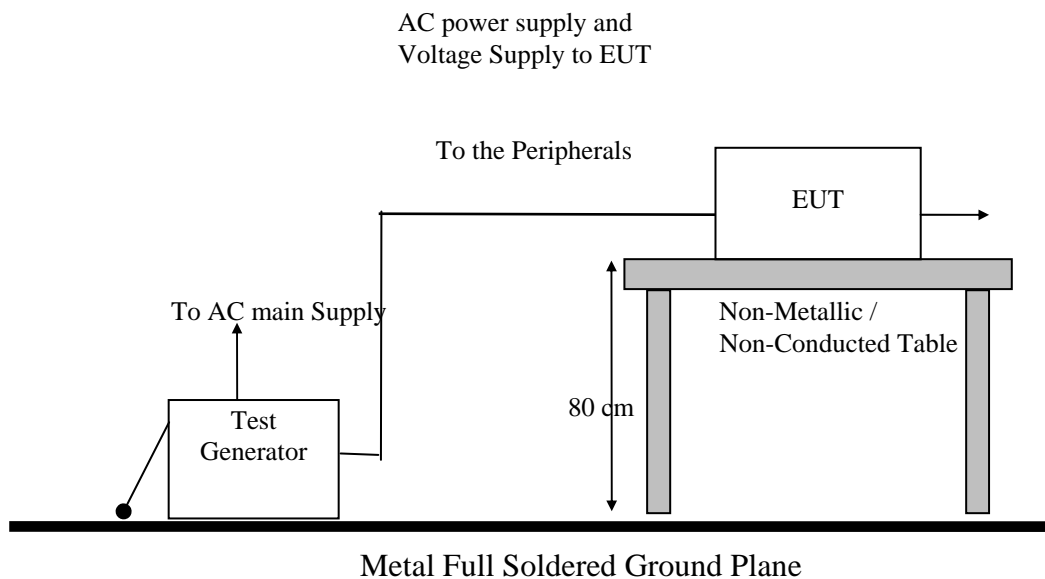

#### Test Result

**Performance of EUT complies with the given specification.**

## 9. Immunity to Conductive Disturbance

### 9.1 Immunity to Conductive Disturbance

Port:	AC mains; Twisted Pair LAN Port
Basic Standard:	EN 61000-4-6/ IEC EN61000-4-6 (details referred to Sec 1.2)
Test Level::	3 V
Modulation:	AM 1KHz 80%
Frequency range:	0.15 MHz - 80MHz
Frequency Step:	1% of last Frequency
Dwell time:	3s
Criteria:	A
CDN Type:	CDN M2+M3, CDN T2, CDN T4, CDN T8, EM Clamp
Test Procedure	refer to ISL QA -T4-E-S11
Temperature:	25°C
Humidity:	51%

#### Test Setup

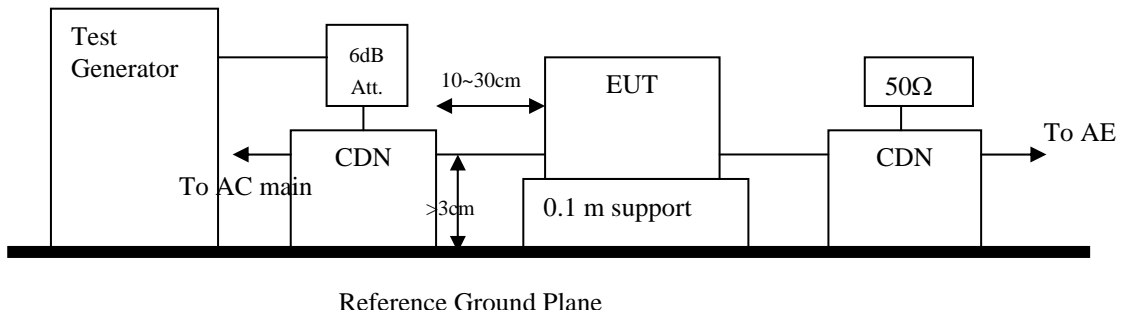

#### Test Result

Performance of EUT complies with the given specification.



## 10. Power Frequency Magnetic Field immunity

### 10.1 Power Frequency Magnetic field immunity test

Port:	Enclosure
Basic Standard:	EN 61000-4-8/ IEC EN61000-4-8 (details referred to Sec 1.2)
Test Level:	1A/m
Polarization:	X, Y, Z
Criteria:	A
Test Procedure	refer to ISL QA -T4-E-S12
Temperature:	25°C
Humidity:	59%

#### Test Setup

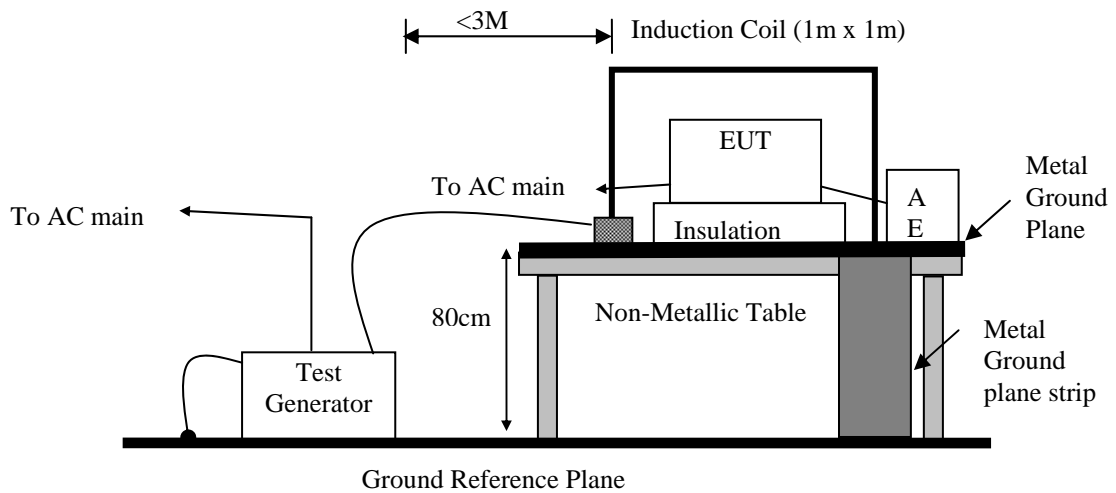

#### Test Result

**Performance of EUT complies with the given specification.**

# 11. Voltage Dips, Short Interruption and Voltage Variation immunity

## 11.1 Voltage Dips, Short Interruption and Voltage Variation immunity test

Port:	AC mains
Basic Standard:	EN 61000-4-11/ IEC EN61000-4-11 (details referred to Sec 1.2)
Test Level: Criteria:	>95% in 0.5 period B
Test Level: Criteria:	30% in 25 period C
Test Level: Criteria:	>95% in 250 period C
Phase:	0°; 180°
Test intervals:	3 times with 10s each
Test Procedure	refer to ISL QA -T4-E-S13
Temperature:	25°C
Humidity:	59%

### Test Setup

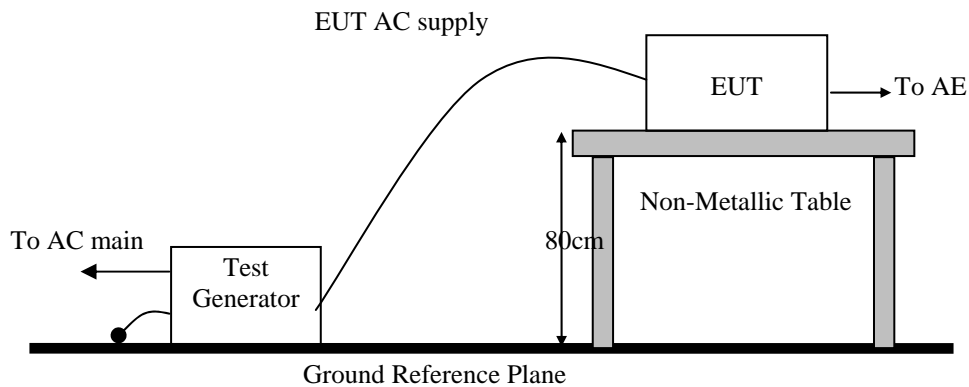

### Test Result

Performance of EUT complies with the given specification.

## 12. Harmonics

### 12.1 Harmonics test

Port:	AC mains
Active Input Power:	>75W
Basic Standard:	EN61000-3-2/IEC 61000-3-2 (details referred to Sec 1.2)
Test Duration:	2.5min
Class:	D
Test Procedure	refer to ISL QA -T4-E-S14
Temperature:	24°C
Humidity:	60%

#### **Test Procedure**

The EUT is supplied in series with shunts or current transformers from a source having the same nominal voltage and frequency as the rated supply voltage and frequency of the EUT. The EUT is configured to its rated current with additional resistive load when the testing is performed.

Equipment having more than one rated voltage shall be tested at the rated voltage producing the highest harmonics as compared with the limits.

#### **Result**

**Performance of EUT complies with the given specification.**

### Test Data

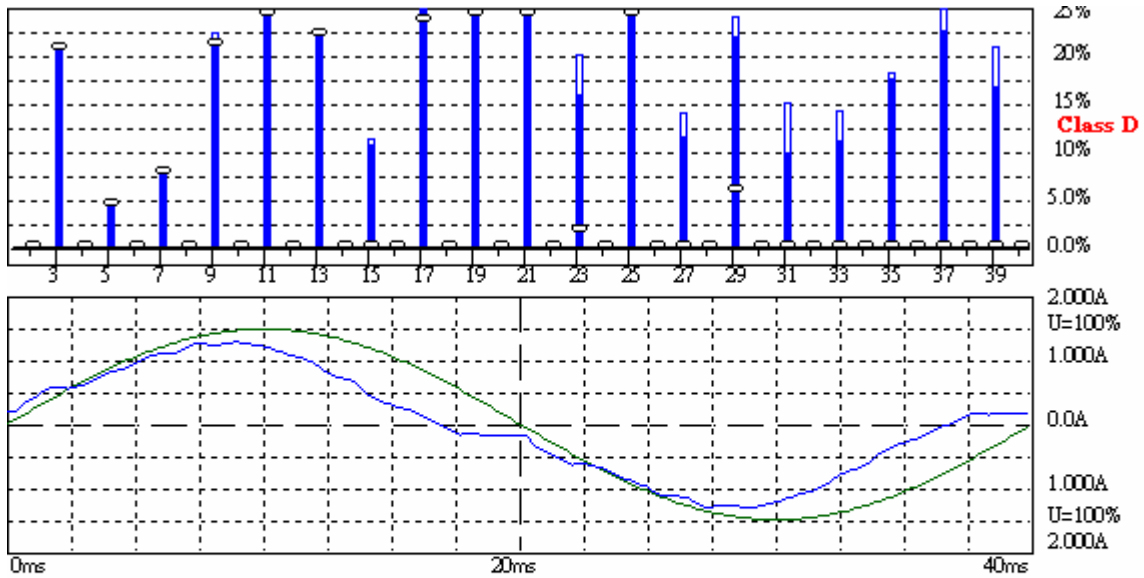

Harmonic Emission - IEC 61000-3-2, EN 61000-3-2, (EN60555-2)

2011/5/23 PM 02:45:5

Urms =	229.9	V	P =	161.2	W	THC =	0.129	A	Range:	2 A
Irms =	0.759	A	pf =	0.924		Pmax =	172.9	W	V-nom:	230 V
									TestTime:	5 min (100%)

Test completed, Result: PASSED

HAR-1000 EMC-Retnet

Full Bar : Actual Values  
 Empty Bar : Maximum Values  
 Blue : Current , Green : Voltage , Red : Failed

### Measurement

Date : 2011/5/23 PM 02:45:5 V4.16

Urms = 229.9V Freq = 50.000 Range: 2 A  
 Irms = 0.759A Ipk = 1.308A cf = 1.723  
 P = 161.2W S = 174.5VA pf = 0.924  
 THDi = 16.5 % THDu = 0.10 % Class D

Test - Time : 5min ( 100 %)

Limit Reference: Pmax = 172.95W

Test completed, Result: PASSED

Order	Freq. [Hz]	Iavg [A]	Iavg%L [%]	Irms [A]	Irms%L [%]	I <sub>max</sub> [A]	I <sub>max</sub> %L [%]	Limit [A]	Status
1	50	0.7707		0.7654		0.7968			
2	100	0.0106		0.0088		0.0132			
3	150	0.1218	20.722	0.1208	20.552	0.1246	21.196	0.5880	
4	200	0.0000		0.0009		0.0013			
5	250	0.0148	4.5106	0.0146	4.4579	0.0150	4.5693	0.3286	
6	300	0.0000		0.0004		0.0005			
7	350	0.0136	7.8596	0.0134	7.7641	0.0140	8.1171	0.1729	
8	400	0.0000		0.0005		0.0009			
9	450	0.0183	21.154	0.0186	21.457	0.0192	22.163	0.0865	
10	500	0.0000		0.0006		0.0010			
11	550	0.0198	32.775	0.0195	32.267	0.0208	34.283	0.0605	
12	600	0.0000		0.0005		0.0006			
13	650	0.0114	22.280	0.0115	22.403	0.0116	22.642	0.0512	
14	700	0.0000		0.0004		0.0005			
15	750	0.0000	0.0000	0.0046	10.450	0.0049	11.000	0.0444	
16	800	0.0000		0.0010		0.0015			
17	850	0.0093	23.768	0.0098	24.933	0.0106	27.115	0.0392	
18	900	0.0000		0.0013		0.0020			
19	950	0.0101	28.845	0.0093	26.473	0.0121	34.485	0.0350	
20	1000	0.0000		0.0012		0.0018			
21	1050	0.0110	34.685	0.0114	35.805	0.0123	38.885	0.0317	
22	1100	0.0000		0.0015		0.0026			
23	1150	0.0005	1.7934	0.0045	15.602	0.0057	19.818	0.0289	
24	1200	0.0000		0.0015		0.0021			
25	1250	0.0079	29.681	0.0071	26.583	0.0104	38.958	0.0266	
26	1300	0.0000		0.0011		0.0016			
27	1350	0.0000	0.0000	0.0028	11.385	0.0034	13.860	0.0247	
28	1400	0.0000		0.0007		0.0015			
29	1450	0.0013	5.8233	0.0050	21.798	0.0055	23.925	0.0230	
30	1500	0.0000		0.0007		0.0013			
31	1550	0.0000	0.0000	0.0021	9.6616	0.0032	14.777	0.0215	
32	1600	0.0000		0.0006		0.0007			
33	1650	0.0000	0.0000	0.0022	10.890	0.0028	13.915	0.0202	
34	1700	0.0000		0.0005		0.0006			
35	1750	0.0000	0.0000	0.0033	17.325	0.0034	17.967	0.0190	
36	1800	0.0000		0.0005		0.0006			
37	1850	0.0000	0.0000	0.0040	22.385	0.0045	25.098	0.0180	
38	1900	0.0000		0.0005		0.0006			
39	1950	0.0000	0.0000	0.0028	16.445	0.0035	20.735	0.0171	
40	2000	0.0000		0.0005		0.0007			

## 13. Voltage Fluctuations

### 13.1 Voltage Fluctuations test

Port:	AC mains
Basic Standard:	EN61000-3-3/IEC61000-3-3 (details referred to Sec 1.2)
Test Procedure	refer to ISL QA -T4-E-S14
Observation period:	For Pst 10min
	For Plt 2 hours
Temperature:	24°C
Humidity:	60%

#### **Test Procedure**

The EUT is supplied in series with reference impedance from a power source with the voltage and frequency as the nominal supply voltage and frequency of the EUT.

#### **Result**

**Performance of EUT complies with the given specification.**

### Test Data

10Min

Flickermeter 1000-4-15 for 230V/50Hz

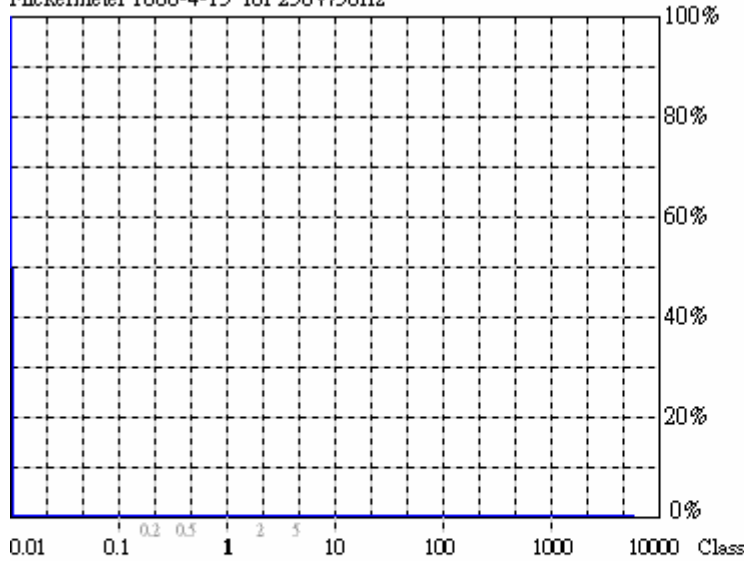

**Actual Flicker (Fli): 0.00**  
**Short-term Flicker (Pst): 0.07**  
 Limit (Pst): 1.00  
**Long-term Flicker (Plt): 0.07**  
 Limit (Plt): 0.65  
**Maximum Relative Volt. Change (dmax): 0.00%**  
 Limit (dmax): 4.00%  
**Relative Steady-state Voltage Change (dc): 0.04%**  
 Limit (dc): 3.30%  
**Maximum Interval exceeding 3.30% (dt): 0.00ms**  
 Limit (dt>Lim): 500ms

**Flicker Emission - IEC 61000-3-3 , EN 61000-3-3 , (EN60555-3)**

2011/5/23 PM 03:36:0

U<sub>rms</sub> = 229.7 V P = 171.6 W  
 I<sub>rms</sub> = 0.804 A pf = 0.929

Range: 2 A  
 V<sub>nom</sub>: 230 V  
 TestTime: 10 min (100%)

**Test completed, Result: PASSED**

HAR-1000 EMC-Retester

120Min

Flickermeter 1000-4-15 for 230V/50Hz

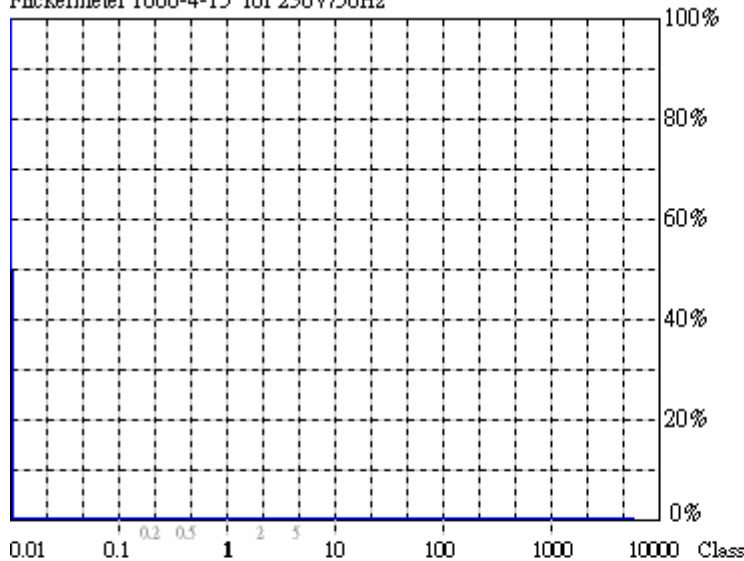

**Actual Flicker (Fli): 0.00**  
**Short-term Flicker (Pst): 0.07**  
 Limit (Pst): 1.00  
**Long-term Flicker (Plt): 0.07**  
 Limit (Plt): 0.65  
**Maximum Relative Volt. Change (dmax): 0.00%**  
 Limit (dmax): 4.00%  
**Relative Steady-state Voltage Change (dc): 0.03%**  
 Limit (dc): 3.30%  
**Maximum Interval exceeding 3.30% (dt): 0.00ms**  
 Limit (dt>Lim): 500ms

**Flicker Emission - IEC 61000-3-3 , EN 61000-3-3 , (EN60555-3)**

2011/5/23 PM 06:05:0

U<sub>rms</sub> = 229.7 V P = 158.5 W  
 I<sub>rms</sub> = 0.748 A pf = 0.922

Range: 2 A  
 V<sub>nom</sub>: 230 V  
 TestTime: 120 min (10000%)

**Test completed, Result: PASSED**

HAR-1000 EMC-Retester

## 14. Appendix

### 14.1 Appendix A: Test Equipment

#### 14.1.1 Test Equipment List

Location	Equipment Name	Brand	Model	S/N	Last Cal. Date	Next Cal. Date
<b>CON01</b>						
Conduction	Coaxial Cable 1F-C1	EMEC	5D Cable	1F-C1	10/25/2010	10/25/2011
Conduction	LISN 02	EMCO	3825/2	1407	07/22/2010	07/22/2011
Conduction	LISN 03	R&S	ESH3-Z5 831.5518.52	828874/010	07/22/2010	07/22/2011
Conduction	ISN T2 03	FCC	FCC-TLISN-T 2-02	20618	08/23/2010	08/23/2011
Conduction	ISN T4 05	FCC	FCC-TLISN-T 4-02	20619	08/23/2010	08/23/2011
Conduction	ISN T8 03	FCC	FCC-TLINS-T 8-02	20620	08/23/2010	08/23/2011
Conduction	EMI Receiver 15	ROHDE & SCHWARZ	ESCI	101166	04/19/2011	04/19/2012

Location	Equipment Name	Brand	Model	S/N	Last Cal. Date	Next Cal. Date
<b>OATS01</b>						
Radiation	BILOG Antenna 10	Sumol Sciences	JB1	A013004-1	07/22/2010	07/22/2011
Radiation	Coaxial Cable 3F-10M	EMCI	CFD400-NL	ISL-R001	03/15/2011	03/15/2012
Radiation	Coaxial Cable 3F-3M	BELDEN	RG-8/U	3F-3M	10/25/2010	10/25/2011
Radiation	EMI Receiver 13	ROHDE & SCHWARZ	ESCI	101015	02/17/2011	02/17/2012

Location	Equipment Name	Brand	Model	S/N	Last Cal. Date	Next Cal. Date
<b>Chamber14</b>						
Rad. Above 1GHz (Chamber14)	Horn Antenna 06	ETS	3117	00066665	09/28/2010	09/28/2011
Rad. Above 1GHz (Chamber14)	Horn Antenna 04	Com-Power	AH-826	081-001	05/04/2011	05/04/2012
Rad. Above 1GHz (Chamber14)	Horn Antenna 05	Com-Power	AH-640	100A	01/11/2011	01/10/2013
Rad. Above 1GHz (Chamber14)	SUCOFLEX 1GHz~18GHz cable	HUBER SUHNER	Sucoflex 106	67618/6 and 67619/6	02/09/2011	02/09/2012
Rad. Above 1GHz (Chamber14)	Preamplifier 15	Agilent	8449B	3008A2471	02/16/2011	02/16/2012
Rad. Above 1GHz (Chamber14)	Preamplifier 13	MITEQ	JS44-0010180 0-25-10P-44	1329256	06/10/2011	06/10/2012
Rad. Above 1GHz (Chamber14)	Spectrum Analyzer 19	R&S	FSP40	100116	10/18/2010	10/18/2011
Rad. Above 1GHz (Chamber14)	Spectrum Analyzer 20	Agilent Technologies	E4443A	MY48250315	05/12/2011	05/11/2012



Location Chamber14	Equipment Name	Brand	Model	S/N	Last Cal. Date	Next Cal. Date
Rad. Above 1GHz (Chamber14)	RF.Pre-selector 01	Agilent Technologies	N9039A	MY46520296	05/12/2011	05/11/2012
Rad. Above 1GHz	SUCOFLEX 1GHz~26.5GHz cable	HUBER+SUHNER AG.	Sucoflex 104	286305/4	09/30/2010	09/30/2011

Location Immunity01	Equipment Name	Brand	Model	S/N	Last Cal. Date	Next Cal. Date
EN61K-3-2/3	DC Burn-In Load 02	D-RAM	DBS-2100	2100-910027	N/A	N/A
EN61K-3-2/3	Harmonic/Flicker Test System 03	EMC Partner	HARMONICS-1000	178	03/29/2011	03/29/2012
EN61K-4-,4,5,8,11	TRANSIENT 2000 01	EMC Partner	TRANSIENT-2000	950	12/01/2010	12/01/2011
EN61K-4-2	ESD GUN 04	Schaffner	NSG 438	489	03/23/2011	03/23/2012
EN61K-4-3	BILOG Antenna 06	Schaffner	CBL6112B	2754	N/A	N/A
EN61K-4-3	Amplifier 80Mz~1GHz 250W	AR	250W1000A	312494	N/A	N/A
EN61K-4-3	Amplifier 800MHz~3.0GHz 60W	AR	60S1G3	312762	N/A	N/A
EN61K-4-3	Broadband coupler 10K~220Mhz	Amplifier Research	DC2500	19810	N/A	N/A
EN61K-4-3	Broadband Coupler 80M~1GHz	Amplifier Research	DC6180	20364	N/A	N/A
EN61K-4-3	Broadband Coupler 1~4GHz	Werlatone	C5291	6516	N/A	N/A
EN61K-4-3	Coaxial Cable Chmb 04-3M-2	Belden	RG-8/U	Chmb 04-3M-2	N/A	N/A
EN61K-4-3	Signal Generator 03	Anritsu	MG3642A	6200162550	03/18/2011	03/18/2012
EN61K-4-4	Digital Oscilloscope	Tektronix	TDS 684A	B010761	N/A	N/A
EN61K-4-4	EFT Clamp	Precision	1604242	CNEFT1000-103	N/A	N/A
EN61K-4-5	CDN-UTP8 01	EMC Partner	CDN-UTP8	032	12/01/2010	12/01/2011
EN61K-4-5	SURGE-TESTER 01	EMC Partner	MIG0603IN3	778	12/01/2010	12/01/2011
EN61K-4-6	6dB Attenuator	Weinschel Corp	33-6-34	BC5975	N/A	N/A
EN61K-4-6	Amplifier 4-6	Amplifier Research	150A100	1-1-R-02157	N/A	N/A
EN61K-4-6	Attenuator 6dB 4-6	BIRO	100-A-FFN-06	0123	N/A	N/A
EN61K-4-6	CDN M2+M3	Frankonia	M2+M3	A3011016	07/22/2010	07/22/2011
EN61K-4-6	CDN T2 01	Frankonia	T2	A3010003	07/22/2010	07/22/2011

Location	Equipment Name	Brand	Model	S/N	Last Cal. Date	Next Cal. Date
Immunity01						
EN61K-4-6	CDN T4 05	FCC Inc.	FCC-801-T4-R J45	08020	08/20/2010	08/20/2011
EN61K-4-6	CDN T8 01	FCC Inc.	FCC-801-T8-R J45	08021	08/20/2010	08/20/2011
EN61K-4-6	EM-Clamp 01	FCC	F-203I-23MM	539	N/A	N/A
EN61K-4-6	Coaxial Cable 4-6 01-1	Harbour Industries	M17/128-RG4 00	4-6 01-1	N/A	N/A
EN61K-4-6	Coaxial Cable 4-6 01-2	Harbour Industries	M17/128-RG4 00	4-6 01-2	N/A	N/A
EN61K-4-6	Coaxial Cable 4-6 01-3	Harbour Industries	M17/128-RG4 00	4-6 01-3	N/A	N/A
EN61K-4-6	KAL-AD RJ45S	BIRO			N/A	N/A
EN61K-4-6	KAL-AD T2	BIRO			N/A	N/A
EN61K-4-6	Passive Impedance Adaptor 4-6	FCC	FCC-801-150- 50-CDN	9758;9759	N/A	N/A
EN61K-4-6, CISPR 13, Antenna	Signal Generator 02	HP	8648B	3642U01040	06/24/2011	06/24/2012
EN61K-4-8	Clamp Meter 4-8	TES	3090	990900322	07/30/2010	07/30/2011
EN61K-4-8	Magnetic Field Antenna	Precision	TRAIZ44B	MF1000-23	N/A	N/A

PS: N/A => The equipment does not need calibration.

#### 14.1.2 Software for Controlling Spectrum/Receiver and Calculating Test Data

Test Item	Filename	Version
EN61000-3-2	HARCS.EXE	4.16
EN61000-3-3	HARCS.EXE	4.16
EN61000-4-3	Tile.Exe	2.0.P
EN61000-4-6	EN61000-4-6 Application Software	1.13.e
EN61000-4-2	N/A	2.0
EN61000-4-4	Tema.EXE	1.69
EN61000-4-5	Tema.EXE	1.69
EN61000-4-8	N/A	
EN61000-4-11	VDS-2002Rs.EXE	2.00

Radiation/Conduction	Filename	Version	Issued Date
Hsichih Conduction	EZ EMC	1.1.4.2	2/10/2007
Hsichih Radiation	EZ EMC	1.1.4.2	1/24/2007
Lung_Tan Radiation	EZ EMC	1.1.4.2	1/24/2007

## 14.2 Appendix B: Uncertainty of Measurement

The measurement uncertainty refers to CISPR 16-4-2:2003. The coverage factor  $k = 2$  yields approximately a 95 % level of confidence.

<Conduction 01>     $\pm 2.946$ dB

<OATS 01 (10M)>

Horizontal

30MHz~200MHz:     $\pm 4.216$  dB

200MHz~1GHz:     $\pm 4.438$  dB

Vertical

30MHz~200MHz:     $\pm 4.342$  dB

200MHz~1GHz:     $\pm 4.426$  dB

<Chamber 14 (3M)>

1GHz~18GHz         $\pm 3.722$  dB

## &lt;Immunity 01&gt;

Test item	Uncertainty
EN61000-4-2 (ESD)	
Voltage	±1.848%
First Peak current	±3.233%
current at 30ns	±3.272%
current at 60ns	±3.376%
EN61000-4-3 (RS)	±1.776dB
EN61000-4-4 (EFT)	
Time	±0.632%
Voltage	±1 %
EN61000-4-5 (Surge)	
Time	±1.159 %
Voltage	±1.633 %
Current	±1.177 %
EN61000-4-6 (CS)	±1.892dB
EN61000-4-8 (Magnetic)	±1.165%
EN61000-4-11 (Dips)	
Time	±1.159%
Voltage	±1.414%
Current	±1.177%
EN61000-3-2 (Harmonics)	±1.224 %
EN61000-3-3 (Fluctuations and Flicker)	±1.224 %

### 14.3 Appendix C: Photographs of EUT Configuration Test Set Up

#### 14.3.1 Photo of Main Power Port Conducted Emission and Telecommunication Port Conducted Emission Measurement

Front View





Back View



### 14.3.2 Photo of Radiated Emission Measurement

Front View (30MHz~1GHz)

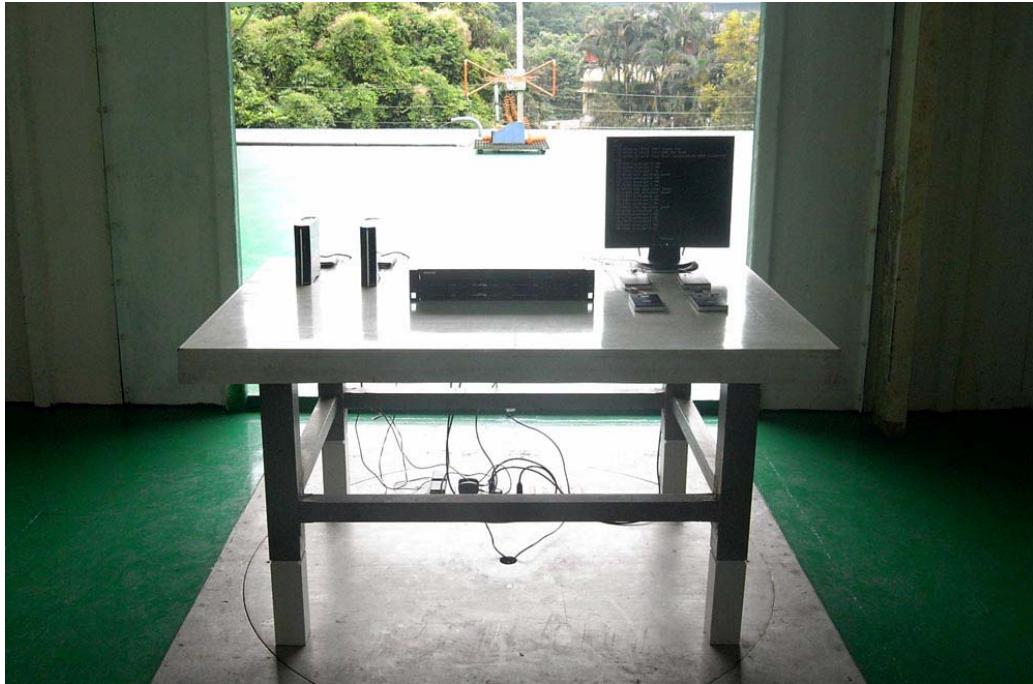

Back View (30MHz~1GHz)





### 14.3.3 Photo of ESD Measurement



### 14.3.4 Photo of RF Field Strength Susceptibility Measurement





### 14.3.5 Photo of Electrical Fast Transient/Burst Measurement

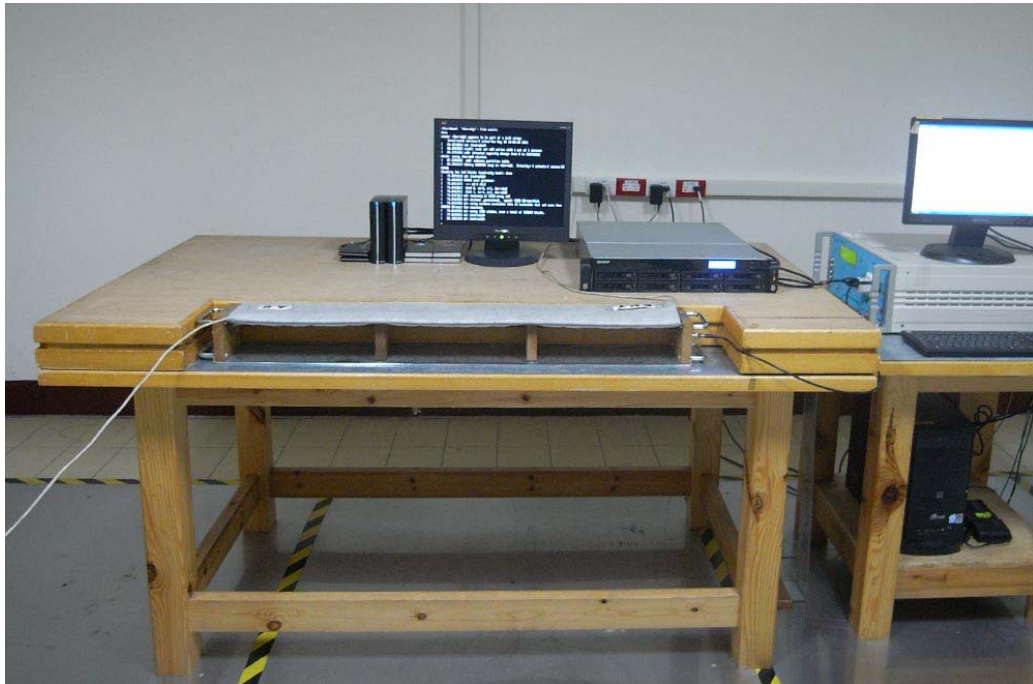

### 14.3.6 Photo of Surge Measurement

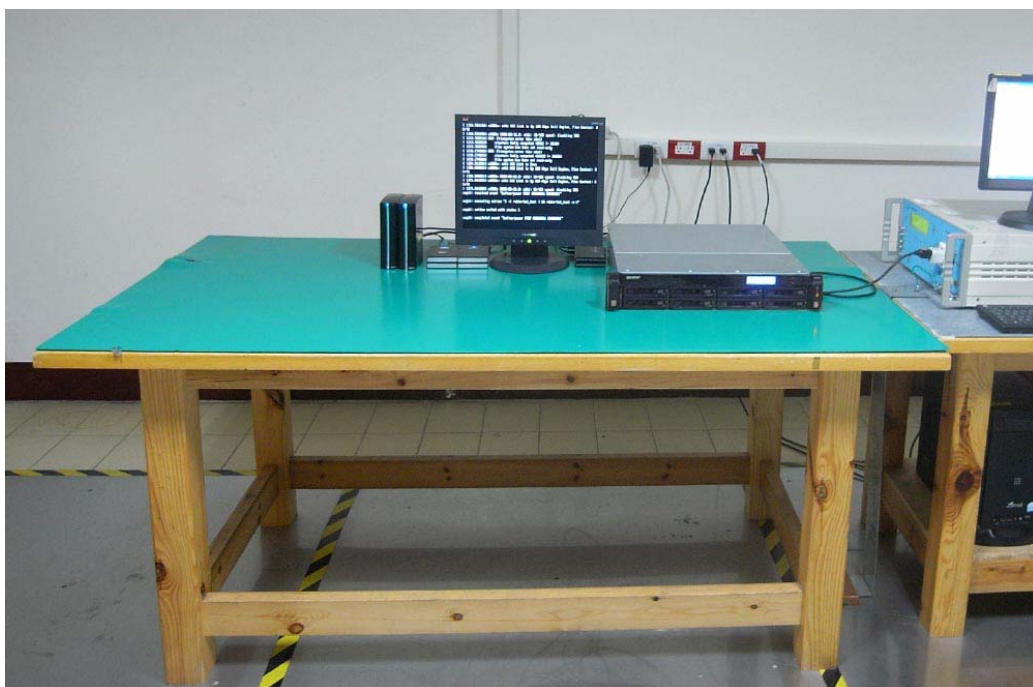





### 14.3.9 Photo of Voltage Dips Measurement

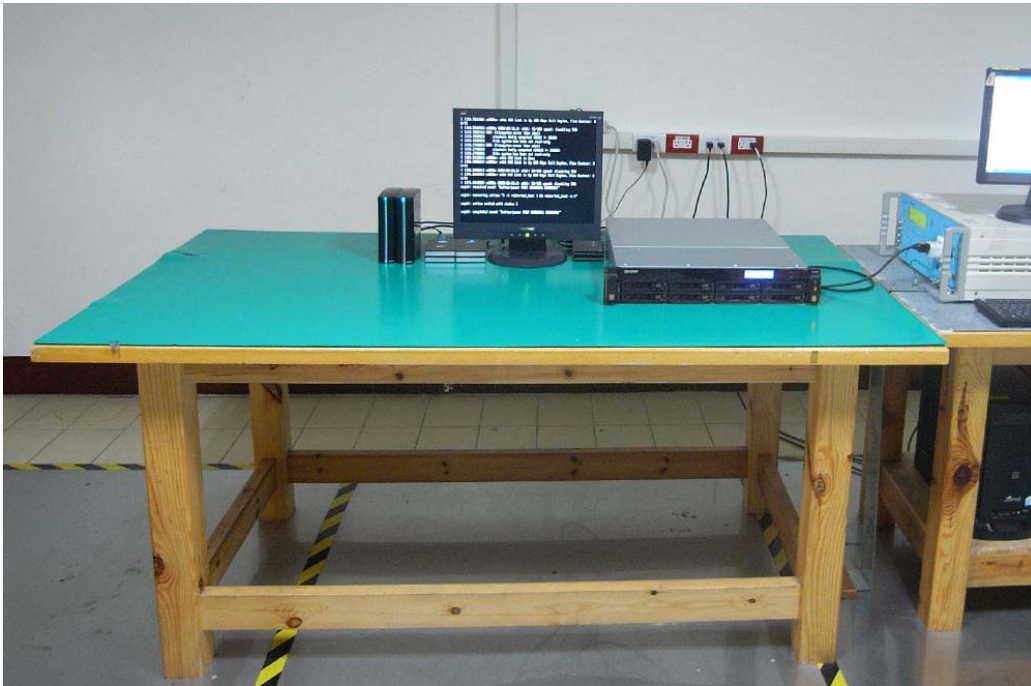

### 14.3.10 Photo of Harmonics and Voltage Fluctuations



#### 14.4 Appendix D: Photographs of EUT

Please refer to the File of ISL-11HE169P