

Certificate

Issue Date: 2010/02/02
Ref. Report No. ISL-10HE026CE

Product Name: : Network Attached Storage
Model(s) : **TS-459U-RP; TS-459U-SP; NAS-459UG-RP; NAS-459UG-SP;
VS-4016U-RP Pro; VS-4012U-RP Pro; VS-4008U-RP Pro, and others**
(Please refer to the attachment)
Responsible Party : **QNAP Systems, Inc.**
Address : 21F, No. 77, Sec. 1, Xintai 5th Rd.
Xizhi City, Taipei County, 221 Taiwan,

We, **International Standards Laboratory**, hereby certify that:

The device bearing the trade name and model specified above has been shown to comply with the applicable technical standards as indicated in the measurement report and was tested in accordance with the measurement procedures specified in European Council Directive- EMC Directive 2004/108/EC. The device was passed the test performed according to :

Standards:

EN 55022:2006 / CISPR 22:2005 / AS/NZS CISPR 22: 2006
EN 61000-3-2: 2006 and IEC 61000-3-2: 2005
EN 61000-3-3: 1995+A1: 2001+A2:2005 and IEC 61000-3-3: 1994+A1: 2001+A2: 2005
EN55024:1998+A1:2001+A2:2003 / CISPR 24:1997+A1:2001+A2:2002
EN 61000-4-2: 1995+A1: 1998+A2: 2001 and IEC 61000-4-2: 1995+A1: 1998+A2: 2000
EN 61000-4-3: 2006 and IEC 61000-4-3: 2006
EN 61000-4-4: 2004 and IEC 61000-4-4: 2004
EN 61000-4-5: 2006 and IEC 61000-4-5: 2005
EN 61000-4-6: 2007 and IEC 61000-4-6: 2003+A1:2004+A2: 2006
EN 61000-4-8: 1993+A1: 2001 and IEC 61000-4-8: 1993+A1: 2000
EN 61000-4-11: 2004 and IEC 61000-4-11: 2004

I attest to the accuracy of data and all measurements reported herein were performed by me or were made under my supervision and are correct to the best of my knowledge and belief. I assume full responsibility for the completeness of these measurements and vouch for the qualifications of all persons taking them.

Jim Chu/ Director

International Standards laboratory

Lung-Tan LAB:

No. 120, Lane 180, San Ho Tsuen, Hsin Ho Rd.
Lung-Tan Hsiang, Tao Yuan County 325, Taiwan
Tel: 886-3-407-1718; Fax: 886-3407-1738

His-Chih LAB:

No. 65, Gu Dai Keng St., Hsichih, Taipei Hsien
22117, Taiwan.
Tel: 886-2-2646-2550; Fax: 886-2-2646-4641

CE MARK TECHNICAL FILE

AS/NZS EMC CONSTRUCTION FILE

of

Product Name

Network Attached Storage

Model

**TS-459U-RP;TS-459U-SP;NAS-459UG-RP;NAS-459UG-S
P;VS-4016U-RP Pro;VS-4012U-RP Pro;VS-4008U-RP
Pro, and others (Please refer to the attachment)**

Contains:

1. Declaration of Conformity
2. EN55022/CISPR 22, AS/NZS CISPR 22 EMI test report
3. EN55024/CISPR 24, EN61000-3-2 / IEC 61000-3-2, and EN61000-3-3 / IEC 61000-3-3 test report
4. Certificate of EN60950-1
5. Block Diagram and Schematics
6. Users' manual

Declaration of Conformity

Name of Responsible Party: QNAP Systems, Inc.
Address of Responsible Party: 21F, No. 77, Sec. 1, Xintai 5th Rd.
Xizhi City, Taipei County, 221
Taiwan,
Declares that product: Network Attached Storage
Model: **TS-459U-RP;TS-459U-SP;NAS-459UG-RP;NAS-459UG-SP;
VS-4016U-RP Pro;VS-4012U-RP Pro;VS-4008U-RP Pro, and
others (Please refer to the attachment)**
Assembled by: Same as above
Address: Same as above

Conforms to the EMC Directive 2004/108/EC as attested by conformity with the following harmonized standards:

EN 55022:2006 / CISPR 22:2005 / AS/NZS CISPR 22: 2006: Limits and methods of measurement of Radio Interference characteristics of Information Technology Equipment.
EN55024:1998+A1:2001+A2:2003 / CISPR 24:1997+A1:2001+A2:2002: Information technology equipment-Immunity characteristics-Limits and methods of measurement.

Standard	Description	Results	Criteria
EN 61000-4-2: 1995+A1: 1998+A2: 2001 IEC 61000-4-2: 1995+A1: 1998+A2: 2000	Electrostatic Discharge	Pass	B
EN 61000-4-3: 2006 IEC 61000-4-3: 2006	Radio-Frequency, Electromagnetic Field	Pass	A
EN 61000-4-4: 2004 IEC 61000-4-4: 2004	Electrical Fast Transient/Burst	Pass	B
EN 61000-4-5: 2006 IEC 61000-4-5: 2005	Surge	Pass	B
EN 61000-4-6: 2007 IEC 61000-4-6: 2003+A1:2004+A2: 2006	Conductive Disturbance	Pass	A
EN 61000-4-8: 1993+A1: 2001 IEC 61000-4-8: 1993+A1: 2000	Power Frequency Magnetic Field	Pass	A

<to be continued>

EN 61000-4-11: 2004 IEC 61000-4-11: 2004	Voltage Dips / Short Interruption and Voltage Variation		
	>95% in 0.5 period	Pass	B
	30% in 25 period	Pass	C
	>95% in 250 period	Pass	C

Standard	Description	Results
EN 61000-3-2: 2006 IEC 61000-3-2: 2005	Limits for harmonics current emissions	Pass
EN 61000-3-3: 1995+A1: 2001+A2:2005 IEC 61000-3-3: 1994+A1: 2001+A2: 2005	Limits for voltage fluctuations and flicker in low-voltage supply systems.	Pass

Conforms to the Low Voltage Directive 2006/95/EC, 93/68/EEC as attested by conformity with the following harmonized standard:

EN60950-1: 2006: Safety of Information Technology Equipment Including electrical business equipment

We, QNAP Systems, Inc., hereby declare that the equipment bearing the trade name and model number specified above was tested conforming to the applicable Rules under the most accurate measurement standards possible, and that all the necessary steps have been taken and are in force to assure that production units of the same equipment will continue to comply with the requirements.

 QNAP Systems, Inc.

Date: 2010/02/02

Declaration of Conformity

Name of Responsible Party: QNAP Systems, Inc.

Address of Responsible Party: 21F, No. 77, Sec. 1, Xintai 5th Rd.
Xizhi City, Taipei County, 221
Taiwan,

Declares that product: Network Attached Storage

Model: **TS-459U-RP;TS-459U-SP;NAS-459UG-RP;NAS-459UG-SP;
VS-4016U-RP Pro;VS-4012U-RP Pro;VS-4008U-RP Pro, and
others (Please refer to the attachment)**

Assembled by: Same as above

Address: Same as above

Conforms to the C-Tick Mark requirement as attested by conformity with the following standards:

EN 55022:2006 / CISPR 22:2005 / AS/NZS CISPR 22: 2006: Limits and methods of measurement of Radio Interference characteristics of Information Technology Equipment.
EN55024:1998+A1:2001+A2:2003 / CISPR 24:1997+A1:2001+A2:2002: Information technology equipment-Immunity characteristics-Limits and methods of measurement.

Standard	Description	Results	Criteria
EN 61000-4-2: 1995+A1: 1998+A2: 2001 IEC 61000-4-2: 1995+A1: 1998+A2: 2000	Electrostatic Discharge	Pass	B
EN 61000-4-3: 2006 IEC 61000-4-3: 2006	Radio-Frequency, Electromagnetic Field	Pass	A
EN 61000-4-4: 2004 IEC 61000-4-4: 2004	Electrical Fast Transient/Burst	Pass	B
EN 61000-4-5: 2006 IEC 61000-4-5: 2005	Surge	Pass	B
EN 61000-4-6: 2007 IEC 61000-4-6: 2003+A1:2004+A2: 2006	Conductive Disturbance	Pass	A

<to be continued>

EN 61000-4-8: 1993+A1: 2001 IEC 61000-4-8: 1993+A1: 2000	Power Frequency Magnetic Field	Pass	A
EN 61000-4-11: 2004 IEC 61000-4-11: 2004	Voltage Dips / Short Interruption and Voltage Variation		
	>95% in 0.5 period	Pass	B
	30% in 25 period	Pass	C
	>95% in 250 period	Pass	C

Standard	Description	Results
EN 61000-3-2: 2006 IEC 61000-3-2: 2005	Limits for harmonics current emissions	Pass
EN 61000-3-3: 1995+A1: 2001+A2:2005 IEC 61000-3-3: 1994+A1: 2001+A2: 2005	Limits for voltage fluctuations and flicker in low-voltage supply systems.	Pass

We, QNAP Systems, Inc., hereby declare that the equipment bearing the trade name and model number specified above was tested conforming to the applicable Rules under the most accurate measurement standards possible, and that all the necessary steps have been taken and are in force to assure that production units of the same equipment will continue to comply with the requirements.

 QNAP Systems, Inc.

Date: 2010/02/02

CE TEST REPORT

of
EN55022 / CISPR 22 / AS/NZS CISPR 22
Class B
EN55024 / CISPR 24 / IMMUNITY
EN61000-3-2 / EN61000-3-3

Product : **Network Attached Storage**

Model(s): **TS-459U-RP;TS-459U-SP;NAS-459UG-RP;
NAS-459UG-SP;VS-4016U-RP Pro; VS-40
12U-RP Pro;VS-4008U-RP Pro, and others
(Please refer to the attachment)**

Applicant: **QNAP Systems, Inc.**

Address: **21F, No. 77, Sec. 1, ,Xintai 5th Rd.
Xizhi City, Taipei County, 221
Taiwan,**

Test Performed by:

International Standards Laboratory

<Hsi-Chih LAB>

*Site Registration No.

BSMI:SL2-IN-E-0037; SL2-R1/R2-E-0037; TAF: 1178;

IC: IC4067; VCCI: R-341,C-354, T-313; NEMKO: ELA 113A

*Address:

No. 65, Gu Dai Keng St.

Hsichih, Taipei Hsien 22117, Taiwan

*Tel: 886-2-2646-2550; Fax: 886-2-2646-4641

Report No.: **ISL-10HE026CE**

Issue Date : **2010/02/02**

Contents of Report

1.	General.....	1
1.1	Certification of Accuracy of Test Data	1
2.	Summary	2
2.1	Operation Environment	2
2.2	Test Standards	2
3.	Description of EUT.....	4
4.	Description of Support Equipment	6
4.1	Description of Support Equipment	6
4.2	Software for Controlling Support Unit.....	7
4.3	I/O Cable Condition of EUT and Support Units	8
5.	Power Main Port Conducted Emissions	9
5.1	Configuration and Procedure.....	9
5.1.1	EUT Configuration	9
5.1.2	Test Procedure	9
5.1.3	EMI Receiver/Spectrum Analyzer Configuration (for the frequencies tested).....	9
5.2	Conduction Test Data: Configuration 1	10
5.3	Conduction Test Data: Configuration 2	12
6.	Telecommunication Port Conducted Emissions	14
6.1	Configuration and Procedure.....	14
6.1.1	EUT Configuration	14
6.1.2	Test Procedure	14
6.1.3	EMI Receiver/Spectrum Analyzer Configuration (for the frequencies tested).....	14
6.2	Test Data: LAN 1--10M (Configuration 1)	15
6.3	Test Data: LAN 2--10M (Configuration 1)	16
6.4	Test Data: LAN 1--10M (Configuration 2)	17
6.5	Test Data: LAN 2--10M (Configuration 2)	18
6.6	Test Data: LAN 1--100M (Configuration 1)	19
6.7	Test Data: LAN 2--100M (Configuration 1)	20
6.8	Test Data: LAN 1--100M (Configuration 2)	21
6.9	Test Data: LAN 2--100M (Configuration 2)	22
6.10	Test Data: LAN 1--GIGA (Voltage) (Configuration 1)	23
6.11	Test Data: LAN 2--GIGA (Voltage) (Configuration 1)	24
6.12	Test Data: LAN 1--GIGA (Voltage) (Configuration 2)	25
6.13	Test Data: LAN 2--GIGA (Voltage) (Configuration 2)	26
7.	Radiated Disturbance Emissions	27
7.1	Configuration and Procedure.....	27
7.1.1	EUT Configuration	27
7.1.2	Test Procedure	27
7.1.3	Spectrum Analyzer Configuration (for the frequencies tested)	27
7.2	Radiation Test Data: Configuration 1	28
7.3	Radiation Test Data: Configuration 2.....	30
8.	Electrostatic discharge (ESD) immunity	32
8.1	Electrostatic discharge (ESD) immunity test	32
9.	Radio-Frequency, Electromagnetic Field immunity.....	33
9.1	Radio-Frequency, Electromagnetic Field immunity test.....	33

10.	Electrical Fast transients/burst immunity	34
10.1	Electrical Fast transient/burst immunity test.....	34
11.	Surge Immunity	36
11.1	Surge immunity test	36
12.	Immunity to Conductive Disturbance.....	37
12.1	Immunity to Conductive Disturbance	37
13.	Power Frequency Magnetic Field immunity	38
13.1	Power Frequency Magnetic field immunity test	38
14.	Voltage Dips, Short Interruption and Voltage Variation immunity	39
14.1	Voltage Dips, Short Interruption and Voltage Variation immunity test	39
15.	Harmonics	40
15.1	Harmonics test.....	40
16.	Voltage Fluctuations	43
16.1	Voltage Fluctuations test.....	43
17.	Appendix.....	45
17.1	Appendix A: Measurement Procedure for Main Power Port Conducted Emissions.....	45
17.2	Appendix B: Measurement Procedure for Telecommunication Port Conducted Emissions.....	46
17.3	Appendix C: Test Procedure for Radiated Emissions.....	47
17.4	Appendix D: Test Equipment.....	48
17.4.1	Test Equipment List.....	48
17.5	Software for Controlling Spectrum/Receiver and Calculating Test Data.....	50
17.6	Appendix E: Layout of EUT and Support Equipment	51
17.6.1	General Power Main Port Conducted Test Configuration.....	51
17.6.2	General Telecommunication Port Conducted Emission Test Configuration	52
17.6.3	General Radiation Test Configuration <30MHz-1000MHz>.....	53
17.7	Appendix F: Uncertainty of Measurement.....	54
17.8	Appendix G: Photographs of EUT Configuration Test Set Up.....	55
17.8.1	Photo of Main Power Port Conducted Emission and Telecommunication Port Conducted Emission Measurement	55
17.8.2	Photo of Radiated Emission Measurement.....	58
17.8.3	Photo of ESD Measurement	60
17.8.4	Photo of RF Field Strength Susceptibility Measurement.....	60
17.8.5	Photo of Electrical Fast Transient/Burst Measurement	61
17.8.6	Photo of Surge Measurement.....	61
17.8.7	Photo of Conductive Measurement.....	62
17.8.8	Photo of Magnetic field Measurement.....	62
17.8.9	Photo of Voltage Dips Measurement.....	63
17.8.10	Photo of Harmonics and Voltage Fluctuations	63
17.9	Photographs of EUT Please refer to the File of ISL-10HE026P	64
18.	Attachment:.....	65

1. General

1.1 Certification of Accuracy of Test Data

Standards: Please refer to 2.2

Equipment Tested: Network Attached Storage

Model: TS-459U-RP;TS-459U-SP;NAS-459UG-RP;NAS-459UG-SP;
VS-4016U-RP Pro;VS-4012U-RP Pro;VS-4008U-RP Pro, and
others (Please refer to the attachment)

Applicant: QNAP Systems, Inc.

Sample received Date: 2010/01/14

Final test Date : 2010/01/22

Test Site: OATS 01, Conduction 01;
Immunity 01

Test Result: PASS

Report Engineer: Lily L.C. Tseng

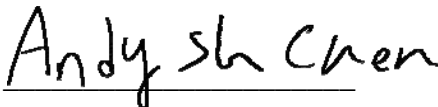
Test Engineer: 
Andy SH Chen

Approve & Signature

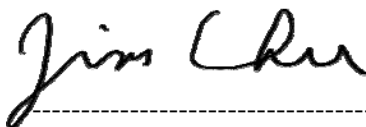

Jim Chu / Director

Test results given in this report apply only to the specific sample(s) tested under stated test conditions.
This report shall not be reproduced other than in full without the explicit written consent of ISL. This report totally
contains 68 pages, including 1 cover page , 2 contents page, and 65 pages for the test description.

This test report accurately contains the test results of the above standards at the time of the test.
The results in this report apply only to the sample(s) tested.
This test report shall not be reproduced except in full, without the written approval of International Standards
Laboratory.

2. Summary

2.1 Operation Environment

Test Distance	10M; 3M (above 1GHz) (EMI test)
Temperature	refer to each site test data
Humidity:	refer to each site test data
input power:	Conduction input power: AC 230 V / 50 Hz Radiation input power: AC 230 V / 50 Hz Immunity input power: AC 230 V / 50 Hz

2.2 Test Standards

The tests which this report describes were conducted by an independent electromagnetic compatibility consultant, International Standards Laboratory in accordance with the following

EN 55022:2006 / CISPR 22:2005 / AS/NZS CISPR 22: 2006: Class B: Limits and methods of measurement of Radio Interference characteristics of Information Technology Equipment.
 EN55024:1998+A1:2001+A2:2003 / CISPR 24:1997+A1:2001+A2:2002: Information technology equipment-Immunity characteristics-Limits and methods of measurement.

Standard	Description	Results	Criteria
EN 61000-4-2: 1995+A1: 1998+A2: 2001 IEC 61000-4-2: 1995+A1: 1998+A2: 2000	Electrostatic Discharge	Pass	B
EN 61000-4-3: 2006 IEC 61000-4-3: 2006	Radio-Frequency, Electromagnetic Field	Pass	A
EN 61000-4-4: 2004 IEC 61000-4-4: 2004	Electrical Fast Transient/Burst	Pass	B
EN 61000-4-5: 2006 IEC 61000-4-5: 2005	Surge	Pass	B
EN 61000-4-6: 2007 IEC 61000-4-6: 2003+A1:2004+A2: 2006	Conductive Disturbance	Pass	A
EN 61000-4-8: 1993+A1: 2001 IEC 61000-4-8: 1993+A1: 2000	Power Frequency Magnetic Field	Pass	A
EN 61000-4-11: 2004 IEC 61000-4-11: 2004	Voltage Dips / Short Interruption and Voltage Variation		
	>95% in 0.5 period	Pass	B
	30% in 25 period	Pass	C
	>95% in 250 period	Pass	C

Standard	Description	Results
EN 61000-3-2: 2006 IEC 61000-3-2: 2005	Limits for harmonics current emissions	Pass
EN 61000-3-3: 1995+A1: 2001+A2:2005 IEC 61000-3-3: 1994+A1: 2001+A2: 2005	Limits for voltage fluctuations and flicker in low-voltage supply systems.	Pass

3. Description of EUT

EUT

Description:	Network Attached Storage
Condition:	Pre-Production
Model:	TS-459U-RP;TS-459U-SP;NAS-459UG-RP;NAS-459UG-SP; VS-4016U-RP Pro;VS-4012U-RP Pro;VS-4008U-RP Pro, and others (Please refer to the attachment)
Serial Number:	N/A
Power Supply Type:	IEI (Model:ACE-R150) *2 AC INPUT: 100~240V 4A, 47~63Hz DC OUTPUT: +12V I max: 8A I min: 0.1A +5V I max: 12A I min: 0.5A +5VSB I max: 0.5A I min: 0.1A Total output wattage: 158W MAX.
DIMM Memory:	ADATA (Model: AD2S800B1G6-B) 1GB DDR2-800MHz
ATA Disk Chip:	Apacer (Model: AP-UM512ME10CG-MS)
Power Switch Button:	one
USB 2.0 Port:	five (4-pins)
RJ45 Connector:	two (8-pins) (10/100/1000Mbps)
E-Serial ATA Port:	two (7pin)
Hard Disk:	Western Digital (Model: WD5000AADS-00S9B0)*4 500GB

All types of EUT Connect have been tested. The worst data listed in this test report.
Test Configuration:

Mode	Hard Disk	LAN1	LAN2	Power Supply
1	Western Digital (Model: WD5000AADS-00S9B0)*4	1000Mbps	1000Mbs	IEI (Model:ACE-R150) *2
2	Western Digital (Model: WD5000AADS-00S9B0)*4	1000Mbps	1000Mbs	IEI (Model:ACE-R150) *1

EMI Noise Source

Crystal: 1MHZ(Y1),12MHz(Y1),25MHz (Y3),25MHz (Y4), , 25MHz (Y5) ,32.768KHz(X1), 14.318MHz (X2)

EMI Solution:

N/A

4. Description of Support Equipment

4.1 Description of Support Equipment

Unit	Model Serial No.	Brand	Power Cord	FCC ID
Notebook Personal Computer	Latitude D400 S/N: N/A	DELL	Non-shielded, Detachable	FCC DOC
17" LCD Monitor	VA703B	View Sonic	Non-shielded, Detachable	FCC DOC
External HDD Enclosure*5	OT-201 S/N: NA	A-TEC	N/A	FCC DOC
Rack mountable Switch	DGS-1008D	D-Link	Non-shielded, Detachable	FCC DOC
E-SATA External Hard Disk*2	QBack-35S	QNAP	Non-shielded, Detachable	FCC DOC

4.2 Software for Controlling Support Unit

Test programs exercising various part of EUT were used. The programs were executed as follows:

- A. Read and write to the disk drives.
- B. R/W External Hard Disk from USB Port.
- C. Read and write data in the E-SATA Hard Disk through EUT E-SATA port.
- D. Send signal from EUT to server through LAN port.
- E. Repeat the above steps.

	Filename	Issued Date
LAN	ping.exe	05/05/1999
EUT Hard Disk	InterEMC.exe	5/21/1996
External Hard Disk	InterEMC.exe	5/21/1996
External Hard Disk	InterEMC.exe	5/21/1996

4.3 I/O Cable Condition of EUT and Support Units

Description	Path	Cable Length	Cable Type	Connector Type
AC Power Cord	110V (~240V) to EUT SPS	1.8M	Nonshielded, Detachable	Plastic Head
LCD Monitor Data Cable	LCD Monitor D-Sub Port to EUT D-Sub Port	1.88M	Non-shielded, Detachable	Metal Head Plastic Head
LAN Data Cable	Server to EUT RJ 45 Connector	33 feet	Non-shielded, Detachable	RJ-45, with Plastic Head
USB Data Cable*5	External HDD Enclosure USB Port to PC USB Port	0.98M	Non-shielded, Detachable (With Core)	Metal Head
LAN Data Cable*2	EUT RJ 45 Connector to Switch RJ 45 Connector.	2.0M	Non-shielded, Detachable	RJ-45, with Plastic Head
E-SATA Data Cable*2	External Hard disk E-S ATA Port to EUT E-SATA Port	1.0M	Shielded, Detachable	Metal Head

5. Power Main Port Conducted Emissions

5.1 Configuration and Procedure

5.1.1 EUT Configuration

The EUT was set up on the non-conductive table that is 1.0 by 1.5 meter, 80cm above ground. The wall was 40cm to the rear of the EUT.

Power to the EUT was provided through the LISN. The impedance vs. frequency characteristic of the LISN is complied with the limit of standards used.

Both lines (neutral and hot) were connected to the LISN in series at testing. A coaxial-type connector which provides one 50 ohms impedance termination was connected to the test instrument. The excess length of the power cord was folded back and forth at the center of the lead to form a bundle 30cm to 40cm in length.

Any changes made to the configuration or modifications made to EUT during testing, are noted in the following test record.

If EUT has an extra auxiliary AC outlet which can provide power to an external monitor, all measurements will be made with the monitor power from EUT-mounted AC outlet and then from floor-mounted AC outlet.

5.1.2 Test Procedure

The system was set up as described above, with the EMI diagnostic software running. The main power line conducted EMI tests were run on both hot and neutral conductors of the power cord and the results were recorded. The effect of varying the position of the interface cables has been investigated to find the configuration that produces maximum emission.

At the frequencies where the peak values of the emissions were higher than 6dB below the applicable limits, the emissions were also measured with the quasi-peak detectors. At the frequencies where the quasi-peak values of the emissions were higher than 6dB below the applicable average limits, the emissions were also measured with the average detectors.

The highest emissions were analyzed in details by operating the spectrum analyzer in fixed tuned mode to determine the nature of the emissions and to provide information which could be useful in reducing their amplitude.

5.1.3 EMI Receiver/Spectrum Analyzer Configuration (for the frequencies tested)

Frequency Range:	150KHz--30MHz
Detector Function:	Quasi-Peak / Average Mode
Resolution Bandwidth:	9KHz

5.2 Conduction Test Data: Configuration 1

Table 5.2.1 Power Line Conducted Emissions (Hot)

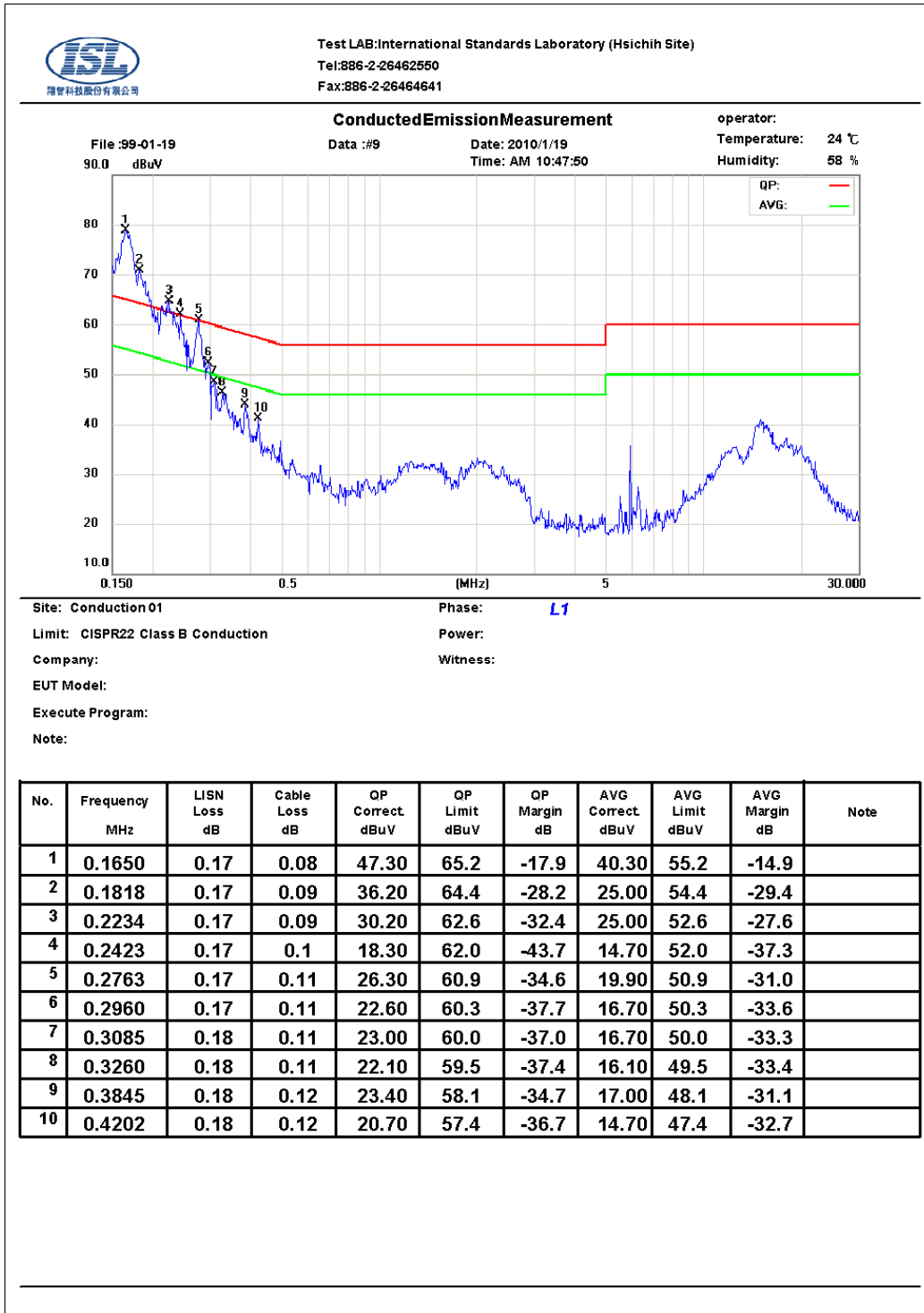

Note:

Margin = Corrected Amplitude - Limit

Corrected Amplitude = Receiver Reading + LISN Loss + Cable Loss

A margin of -8dB means that the emission is 8dB below the limit

The frequency spectrum graph is for final peak graph, and the attached table is for QP/AVG test result.

If peak data can pass, it will be shown in "QP/AVG Correct" column, if not, QP/AVG data will instead.

Table 5.2.2 Power Line Conducted Emissions (Neutral)

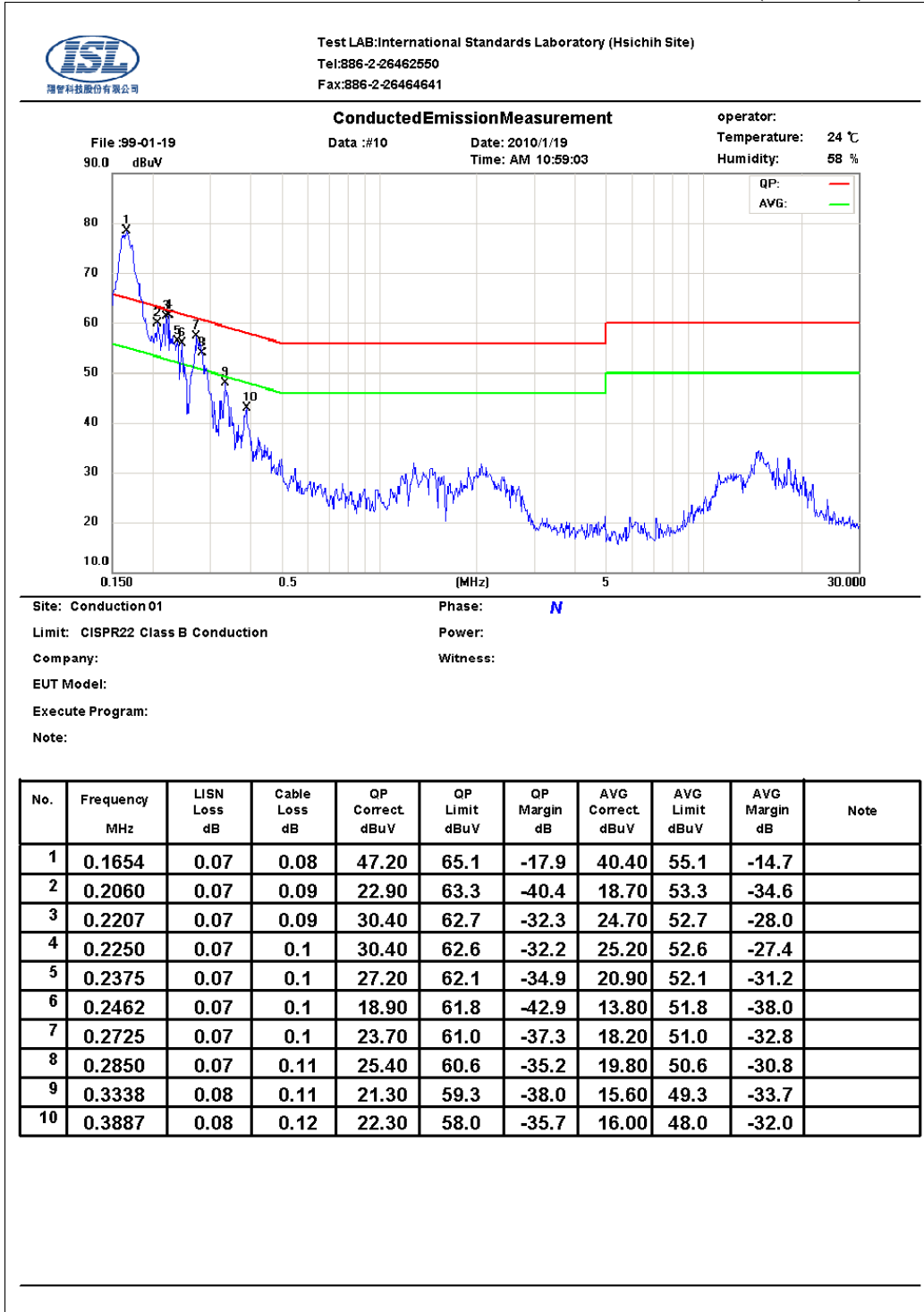

Note:

Margin = Corrected Amplitude - Limit

Corrected Amplitude = Receiver Reading + LISN Loss + Cable Loss

A margin of -8dB means that the emission is 8dB below the limit

The frequency spectrum graph is for final peak graph, and the attached table is for QP/AVG test result.

If peak data can pass, it will be shown in "QP/AVG Correct" column, if not, QP/AVG data will instead.

5.3 Conduction Test Data: Configuration 2

Table 5.3.1 Power Line Conducted Emissions (Hot)

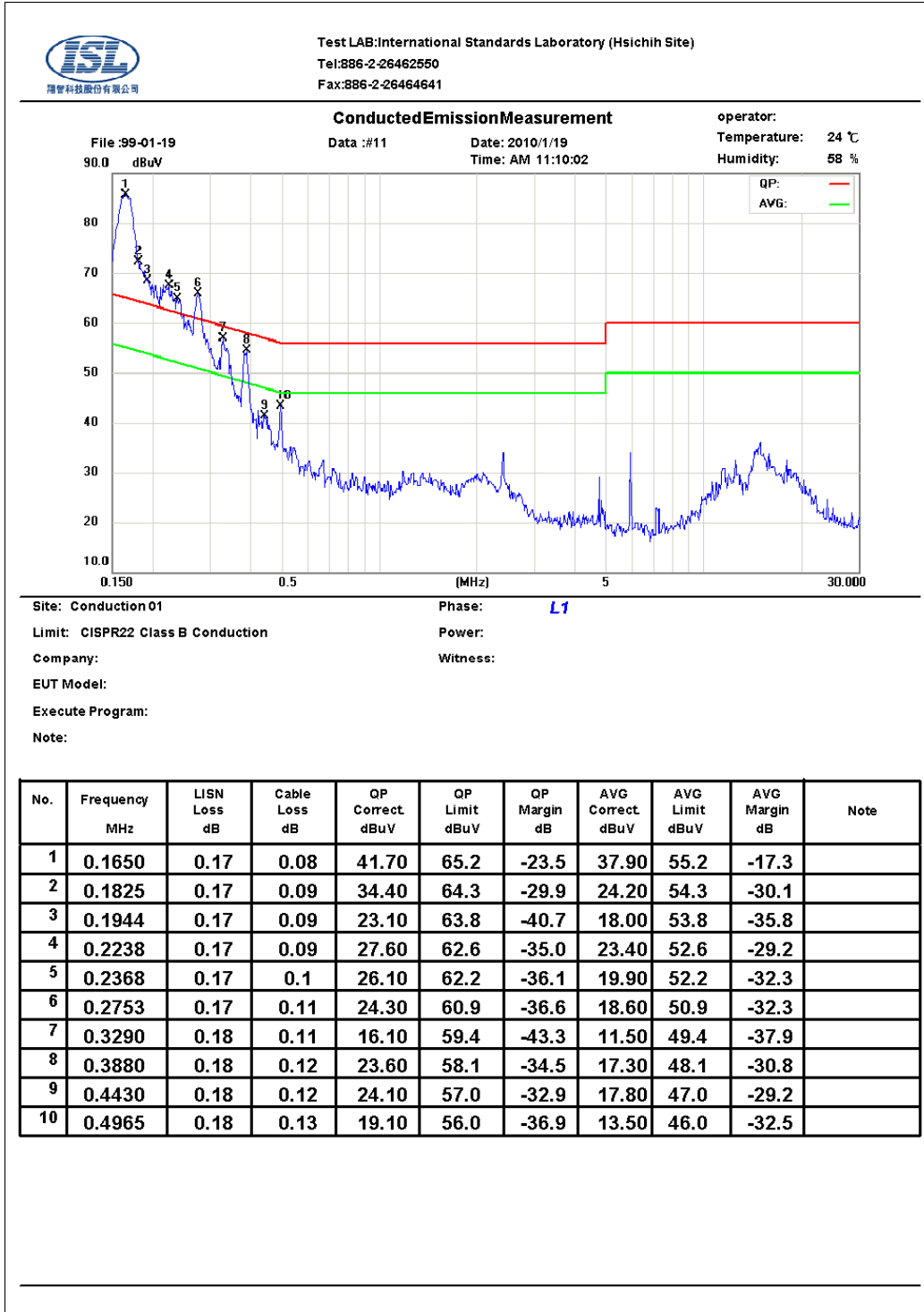

Note:

Margin = Corrected Amplitude - Limit

Corrected Amplitude = Receiver Reading + LISN Loss + Cable Loss

A margin of -8dB means that the emission is 8dB below the limit

The frequency spectrum graph is for final peak graph, and the attached table is for QP/AVG test result.

If peak data can pass, it will be shown in "QP/AVG Correct" column, if not, QP/AVG data will instead.

Table 5.3.2 Power Line Conducted Emissions (Neutral)

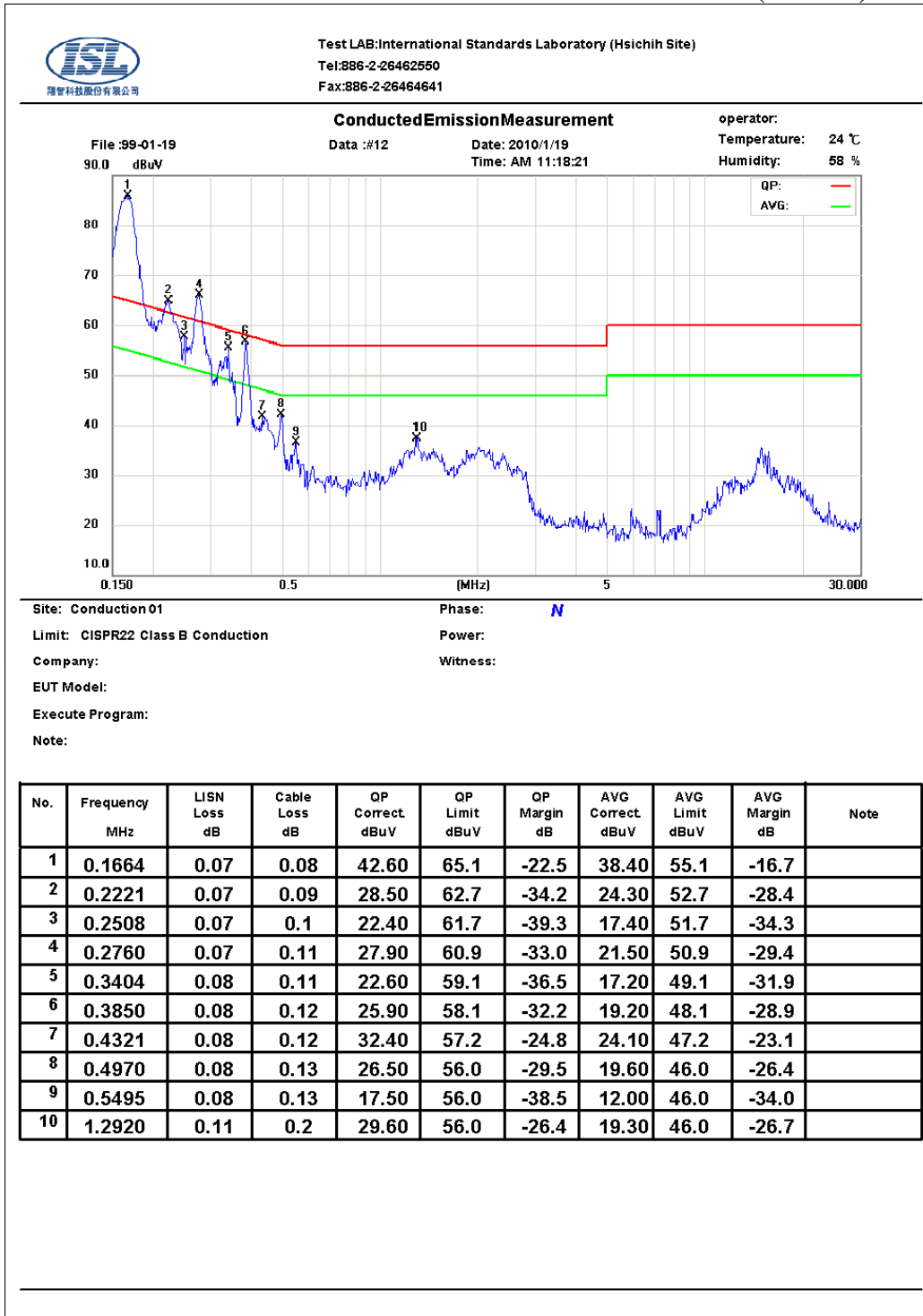

Note:

Margin = Corrected Amplitude - Limit

Corrected Amplitude = Receiver Reading + LISN Loss + Cable Loss

A margin of -8dB means that the emission is 8dB below the limit

The frequency spectrum graph is for final peak graph, and the attached table is for QP/AVG test result.

If peak data can pass, it will be shown in "QP/AVG Correct" column, if not, QP/AVG data will instead.

6. Telecommunication Port Conducted Emissions

6.1 Configuration and Procedure

6.1.1 EUT Configuration

The EUT was set up on the non-conductive table that is 1.0 by 1.5 meter, 80cm above ground. The wall was 40cm to the rear of the EUT. The excess length of the power cord was folded back and forth at the center of the lead to form a bundle 30cm to 40cm in length. The distance between EUT and CDN is 80cm. CDN is connected to the reference ground plane. Any changes made to the configuration, or modifications made to the EUT, during testing are noted in the following test record.

6.1.2 Test Procedure

The system was set up as described above, with the EMI diagnostic software running. The content of the software consist of both periodic and pseudo-random messages. The effect of varying the position of the interface cables has been investigated to find the configuration that produces maximum emission. The highest emissions were analyzed in details by operating the spectrum analyzer in fixed tuned mode to determine the nature of the emissions and to provide information which could be useful in reducing their amplitude.

6.1.3 EMI Receiver/Spectrum Analyzer Configuration (for the frequencies tested)

Frequency Range:	150KHz--30MHz
Detector Function:	Quasi-Peak / Average Mode
Resolution Bandwidth:	9KHz

6.2 Test Data: LAN 1--10M (Configuration 1)

Table 6.2.1 Telecommunication Port Conducted Emission

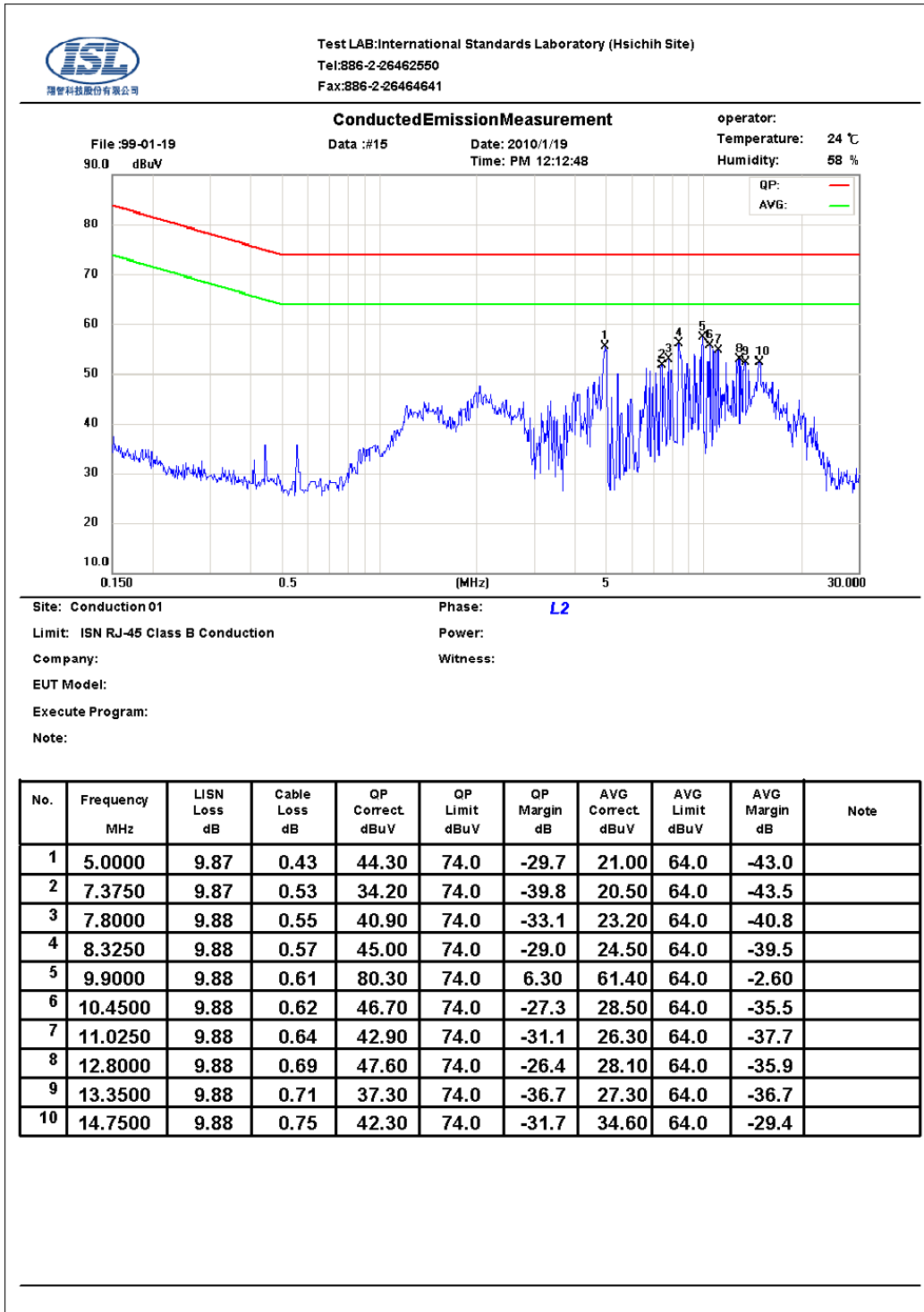

Note :

Margin = Corrected Amplitude - Limit

Corrected Amplitude = Receiver Reading + LISN Loss + Cable Loss

A margin of -8dB means that the emission is 8dB below the limit

The frequency spectrum graph is for final peak graph, and the attached table is for QP/AVG test result.

If peak data can pass, it will be shown in "QP/AVG Correct" column, if not, QP/AVG data will instead.

6.3 Test Data: LAN 2--10M (Configuration 1)

Table 6.3.1 Telecommunication Port Conducted Emission

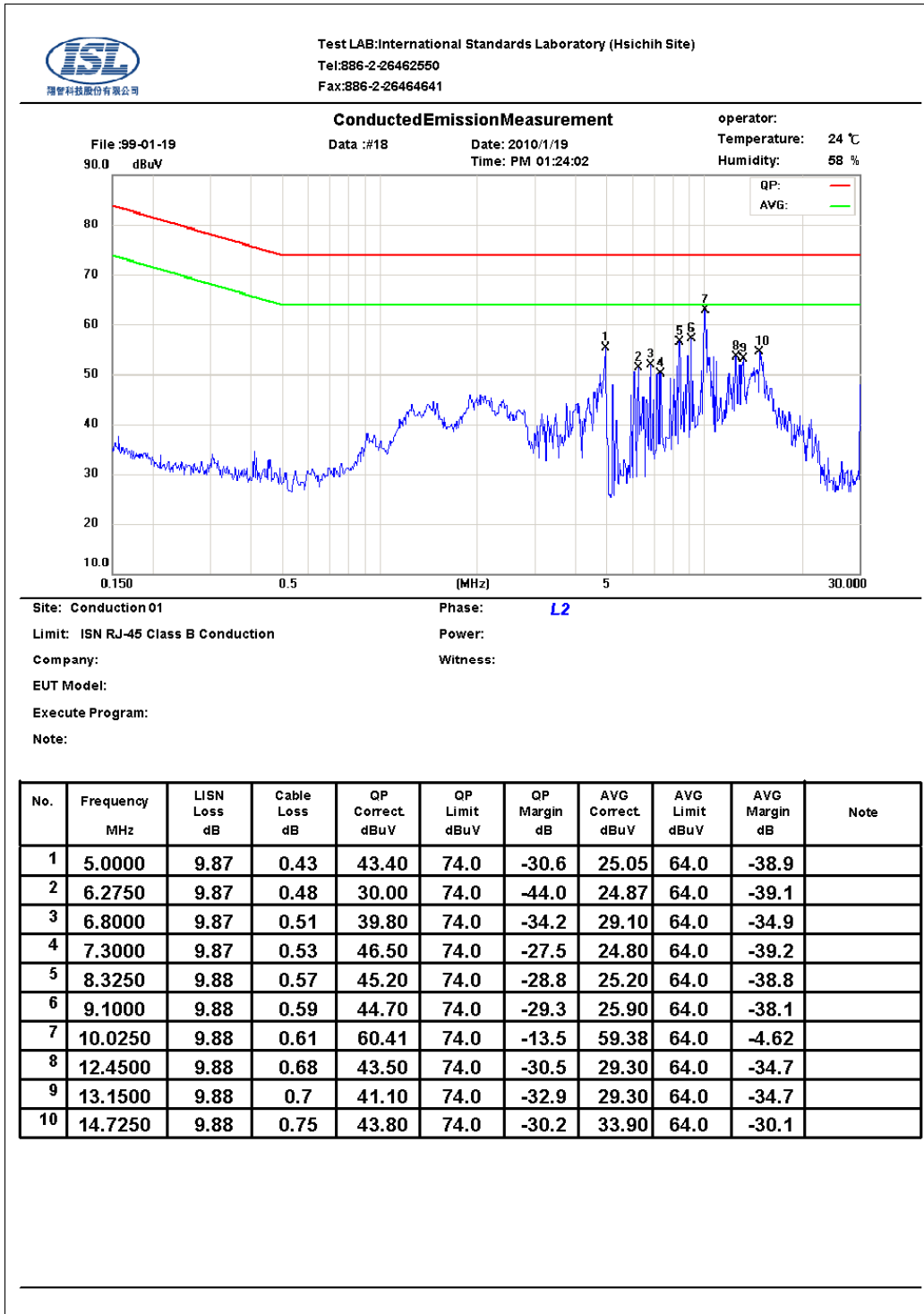

Note :

Margin = Corrected Amplitude - Limit

Corrected Amplitude = Receiver Reading + LISN Loss + Cable Loss

A margin of -8dB means that the emission is 8dB below the limit

The frequency spectrum graph is for final peak graph, and the attached table is for QP/AVG test result.

If peak data can pass, it will be shown in "QP/AVG Correct" column, if not, QP/AVG data will instead.

6.4 Test Data: LAN 1--10M (Configuration 2)

Table 6.4.1 Telecommunication Port Conducted Emission

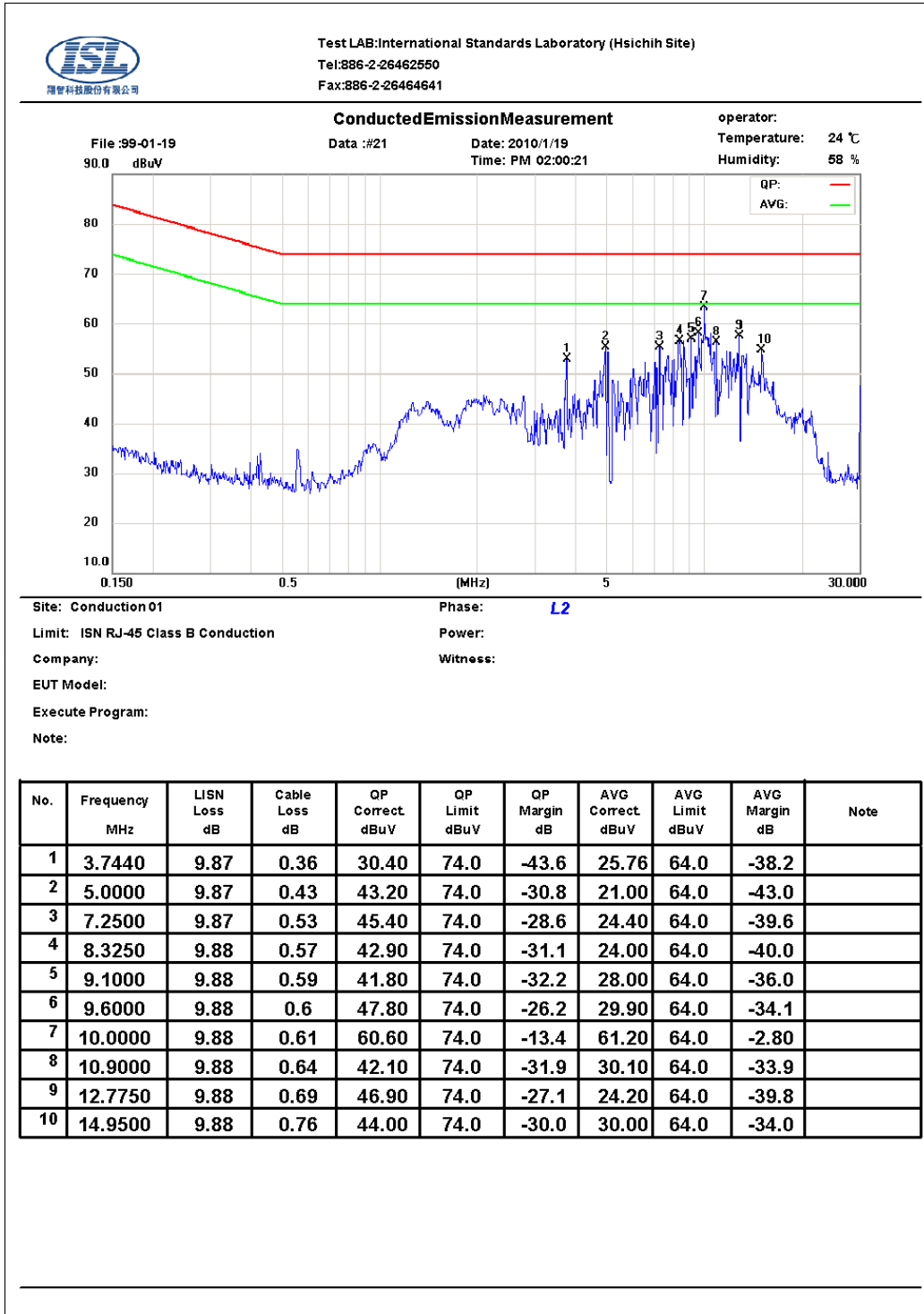

Note :

Margin = Corrected Amplitude - Limit

Corrected Amplitude = Receiver Reading + LISN Loss + Cable Loss

A margin of -8dB means that the emission is 8dB below the limit

The frequency spectrum graph is for final peak graph, and the attached table is for QP/AVG test result.

If peak data can pass, it will be shown in "QP/AVG Correct" column, if not, QP/AVG data will instead.

6.6 Test Data: LAN 1--100M (Configuration 1)

Table 6.6.1 Telecommunication Port Conducted Emission

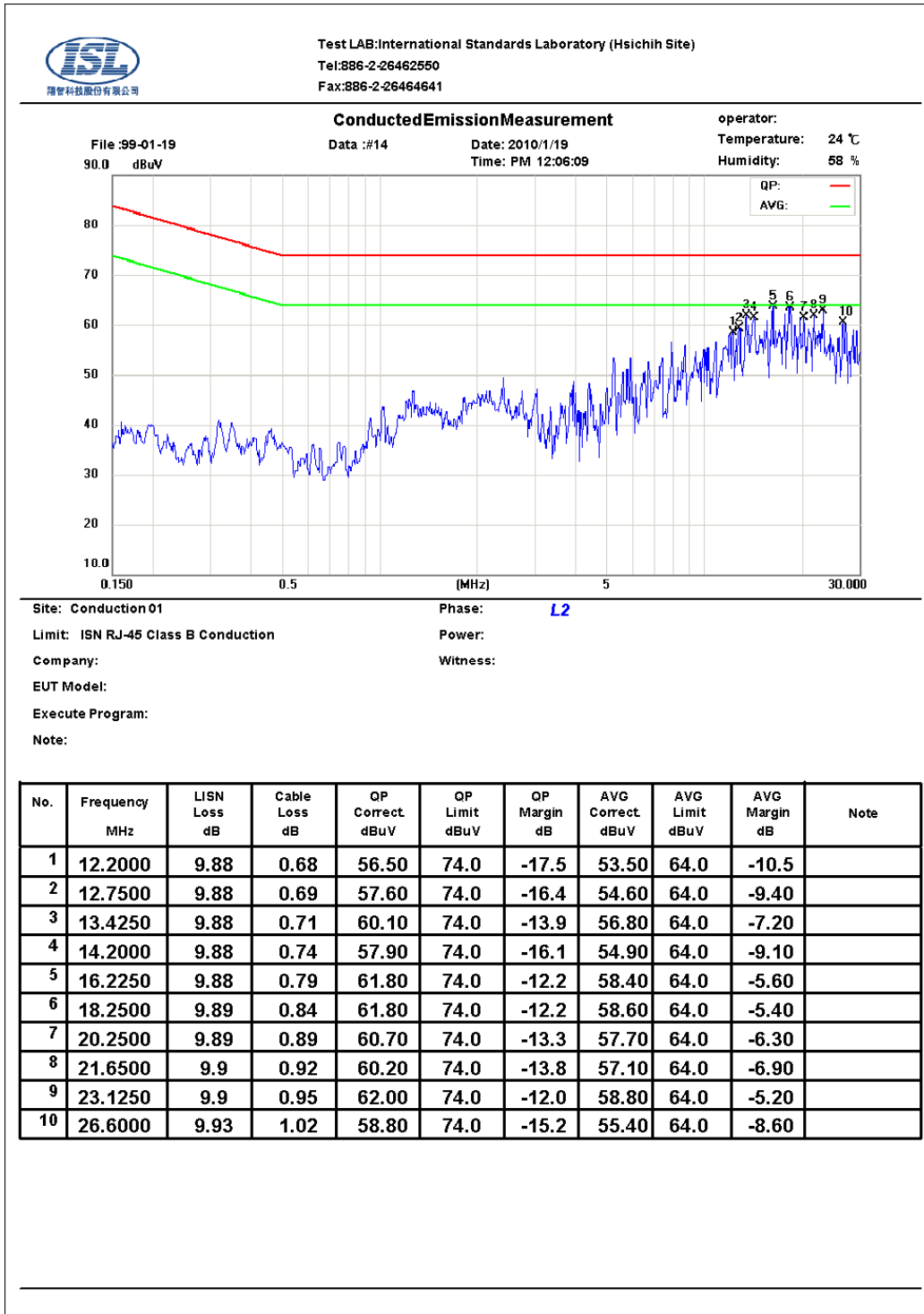

Note :

Margin = Corrected Amplitude - Limit

Corrected Amplitude = Receiver Reading + LISN Loss + Cable Loss

A margin of -8dB means that the emission is 8dB below the limit

The frequency spectrum graph is for final peak graph, and the attached table is for QP/AVG test result.

If peak data can pass, it will be shown in “QP/AVG Correct” column, if not, QP/AVG data will instead.

6.7 Test Data: LAN 2--100M (Configuration 1)

Table 6.7.1 Telecommunication Port Conducted Emission

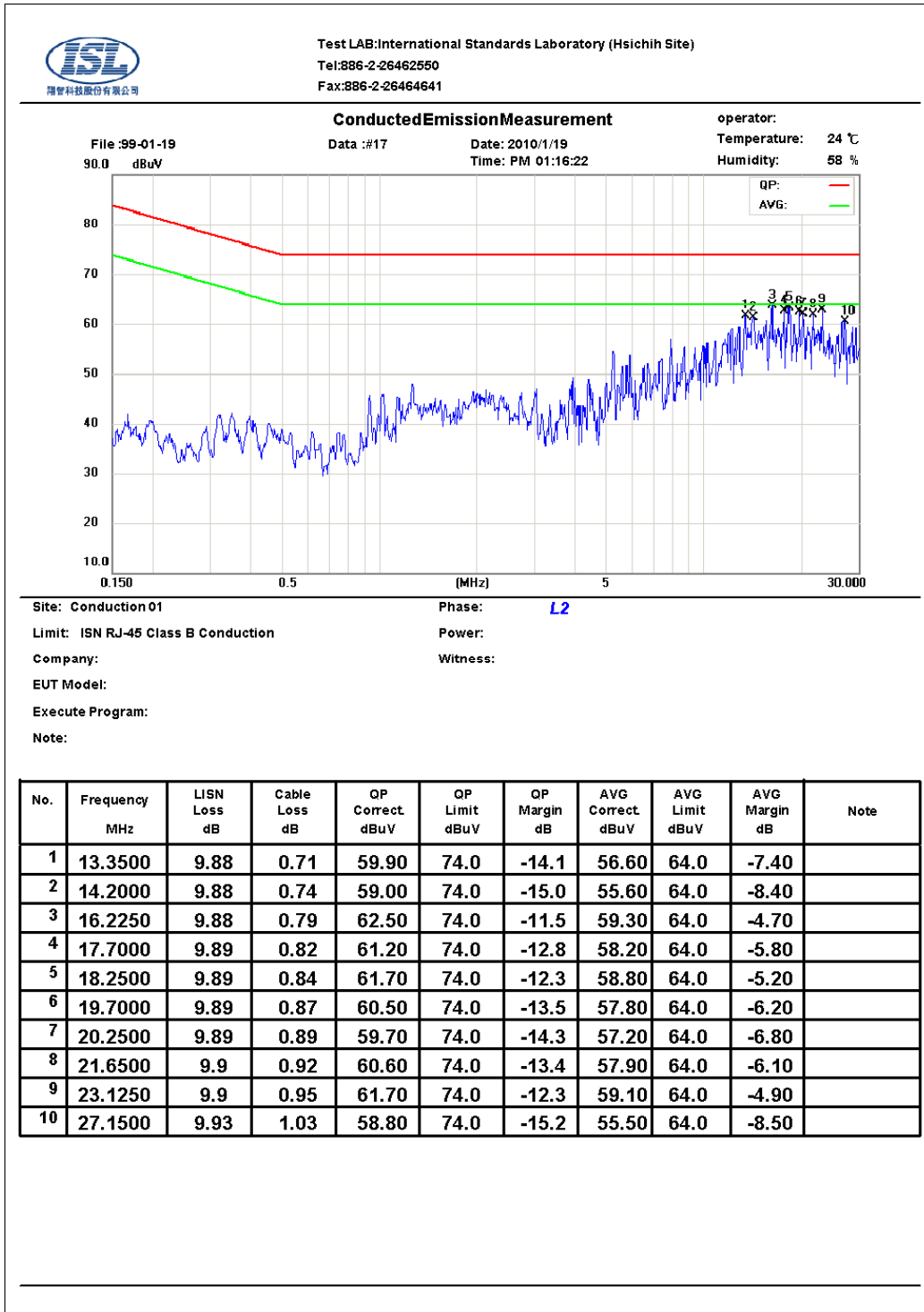

Note :

Margin = Corrected Amplitude - Limit

Corrected Amplitude = Receiver Reading + LISN Loss + Cable Loss

A margin of -8dB means that the emission is 8dB below the limit

The frequency spectrum graph is for final peak graph, and the attached table is for QP/AVG test result.

If peak data can pass, it will be shown in "QP/AVG Correct" column, if not, QP/AVG data will instead.

6.9 Test Data: LAN 2--100M (Configuration 2)

Table 6.9.1 Telecommunication Port Conducted Emission

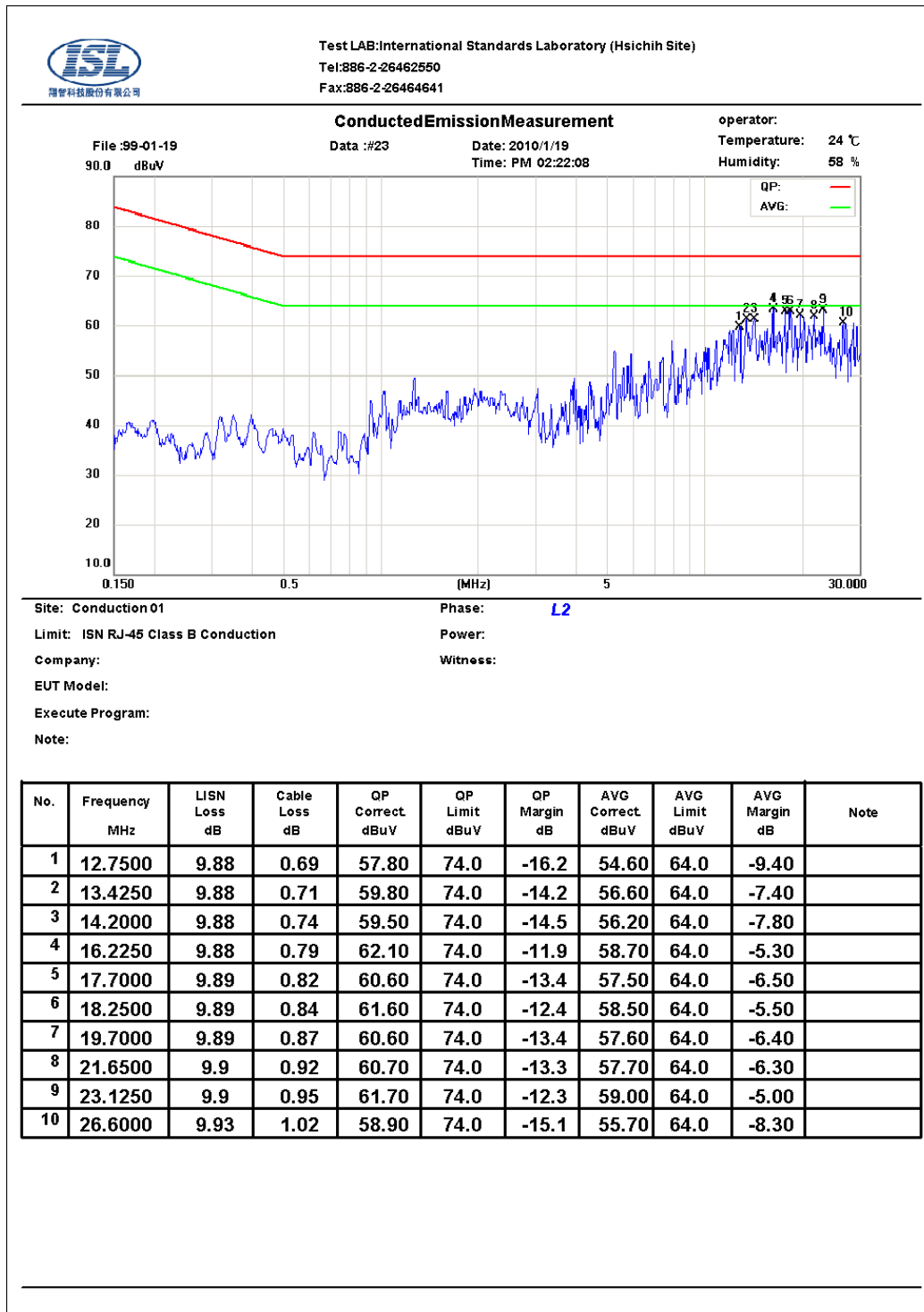

Note :

Margin = Corrected Amplitude - Limit

Corrected Amplitude = Receiver Reading + LISN Loss + Cable Loss

A margin of -8dB means that the emission is 8dB below the limit

The frequency spectrum graph is for final peak graph, and the attached table is for QP/AVG test result.

If peak data can pass, it will be shown in "QP/AVG Correct" column, if not, QP/AVG data will instead.

6.10 Test Data: LAN 1--GIGA (Voltage) (Configuration 1)

Table 6.10.1 Telecommunication Port Conducted Emission



Note :

Margin = Corrected Amplitude - Limit

Corrected Amplitude = Receiver Reading + LISN Loss + Cable Loss

A margin of -8dB means that the emission is 8dB below the limit

The frequency spectrum graph is for final peak graph, and the attached table is for QP/AVG test result.

If peak data can pass, it will be shown in "QP/AVG Correct" column, if not, QP/AVG data will instead.

6.12 Test Data: LAN 1--GIGA (Voltage) (Configuration 2)

Table 6.12.1 Telecommunication Port Conducted Emission

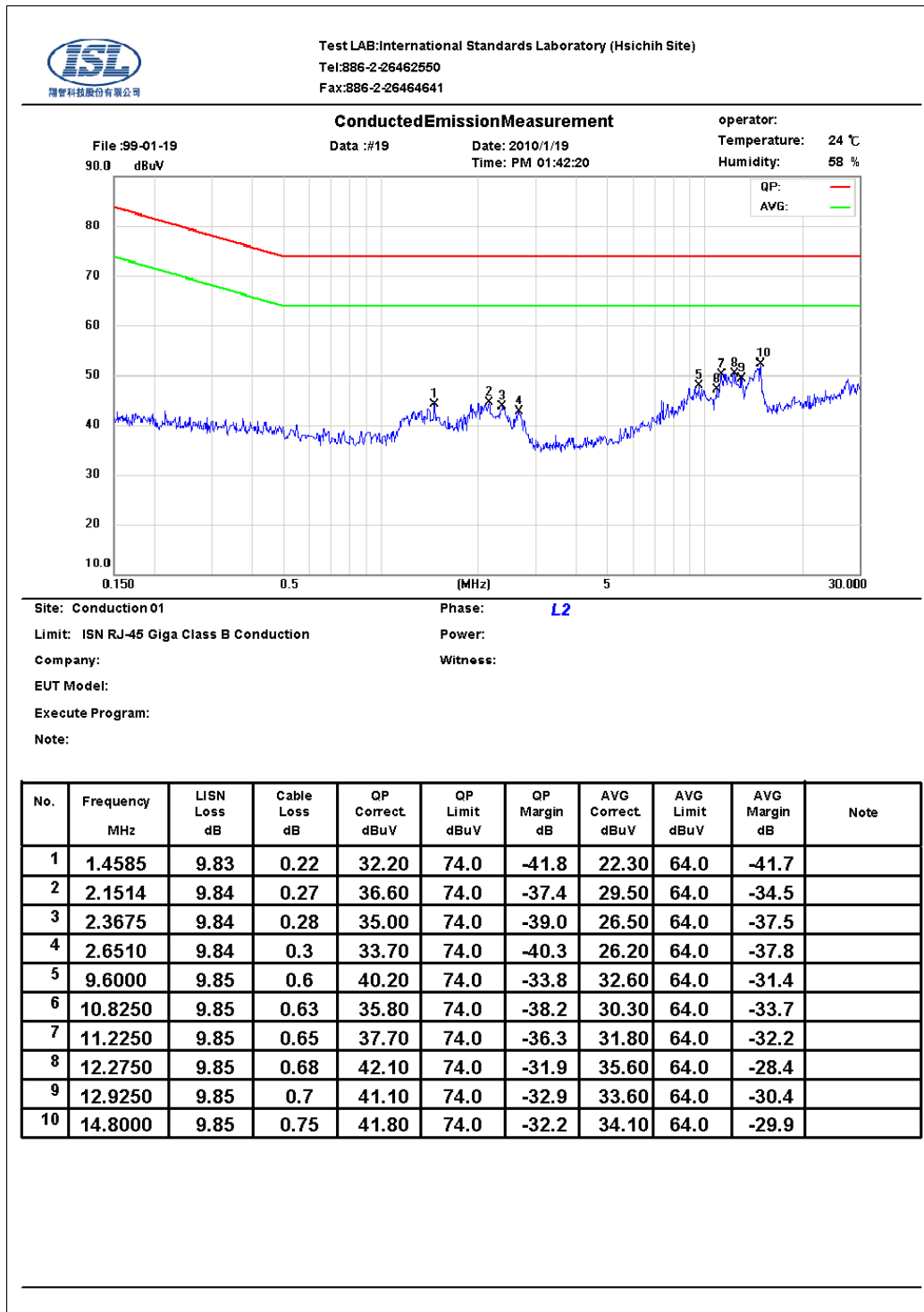

Note :

Margin = Corrected Amplitude - Limit

Corrected Amplitude = Receiver Reading + LISN Loss + Cable Loss

A margin of -8dB means that the emission is 8dB below the limit

The frequency spectrum graph is for final peak graph, and the attached table is for QP/AVG test result.

If peak data can pass, it will be shown in "QP/AVG Correct" column, if not, QP/AVG data will instead.

6.13 Test Data: LAN 2--GIGA (Voltage) (Configuration 2)

Table 6.13.1 Telecommunication Port Conducted Emission

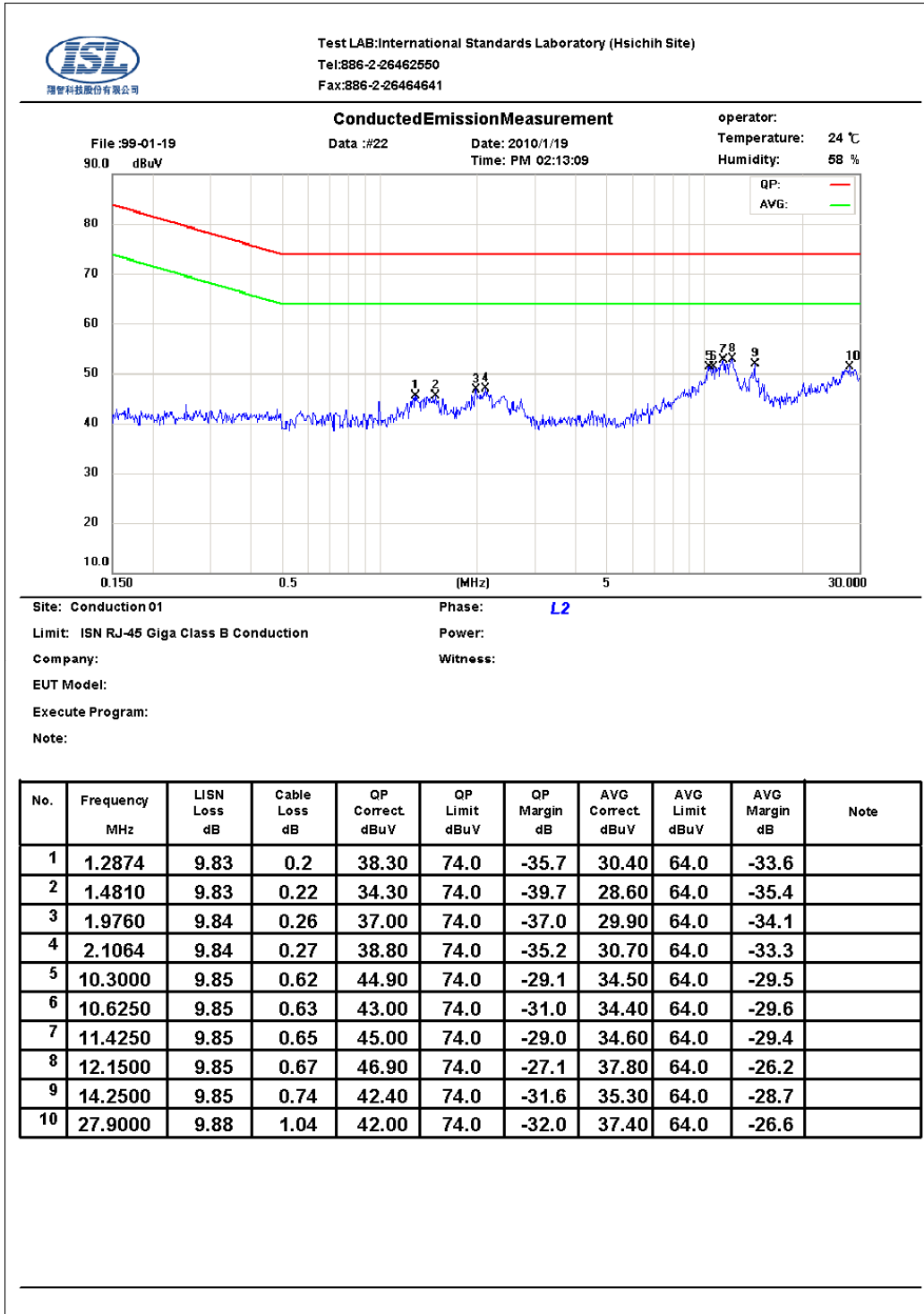

Note :

Margin = Corrected Amplitude - Limit

Corrected Amplitude = Receiver Reading + LISN Loss + Cable Loss

A margin of -8dB means that the emission is 8dB below the limit

The frequency spectrum graph is for final peak graph, and the attached table is for QP/AVG test result.

If peak data can pass, it will be shown in "QP/AVG Correct" column, if not, QP/AVG data will instead.

7. Radiated Disturbance Emissions

7.1 Configuration and Procedure

7.1.1 EUT Configuration

The equipment under test was set up on a non-conductive table 80cm above ground, on open field or chamber. The excess length of the power cord was folded back and forth at the center of the lead to form a bundle 30cm to 40cm in length. Any changes made to the configuration, or modifications made to the EUT, during testing are noted in the following test record.

If EUT has an extra auxiliary AC outlet which can provide power to an external monitor, all measurements will be made with the monitor power from EUT-mounted AC outlet and then from floor-mounted AC outlet.

7.1.2 Test Procedure

The system was set up as described above, with the EMI diagnostic software running. The maximum emission was measured by varying the height of antenna and then by rotating the turntable. Both polarization of antenna, horizontal and vertical, were measured.

The highest emissions between 30 MHz to 1000 MHz were analyzed in details by operating the spectrum analyzer and/or EMI receiver in quasi-peak mode to determine the precise amplitude of the emissions. While doing so, the interconnecting cables and major parts of the system were moved around, the antenna height was varied between one and four meters, its polarization was varied between vertical and horizontal, and the turntable was slowly rotated, to maximize the emission.

7.1.3 Spectrum Analyzer Configuration (for the frequencies tested)

Frequency Range:	30MHz--1000MHz
Detector Function:	Quasi-Peak Mode
Resolution Bandwidth:	120KHz

7.2 Radiation Test Data: Configuration 1

Table 7.2.1 Radiated Emissions (Horizontal)

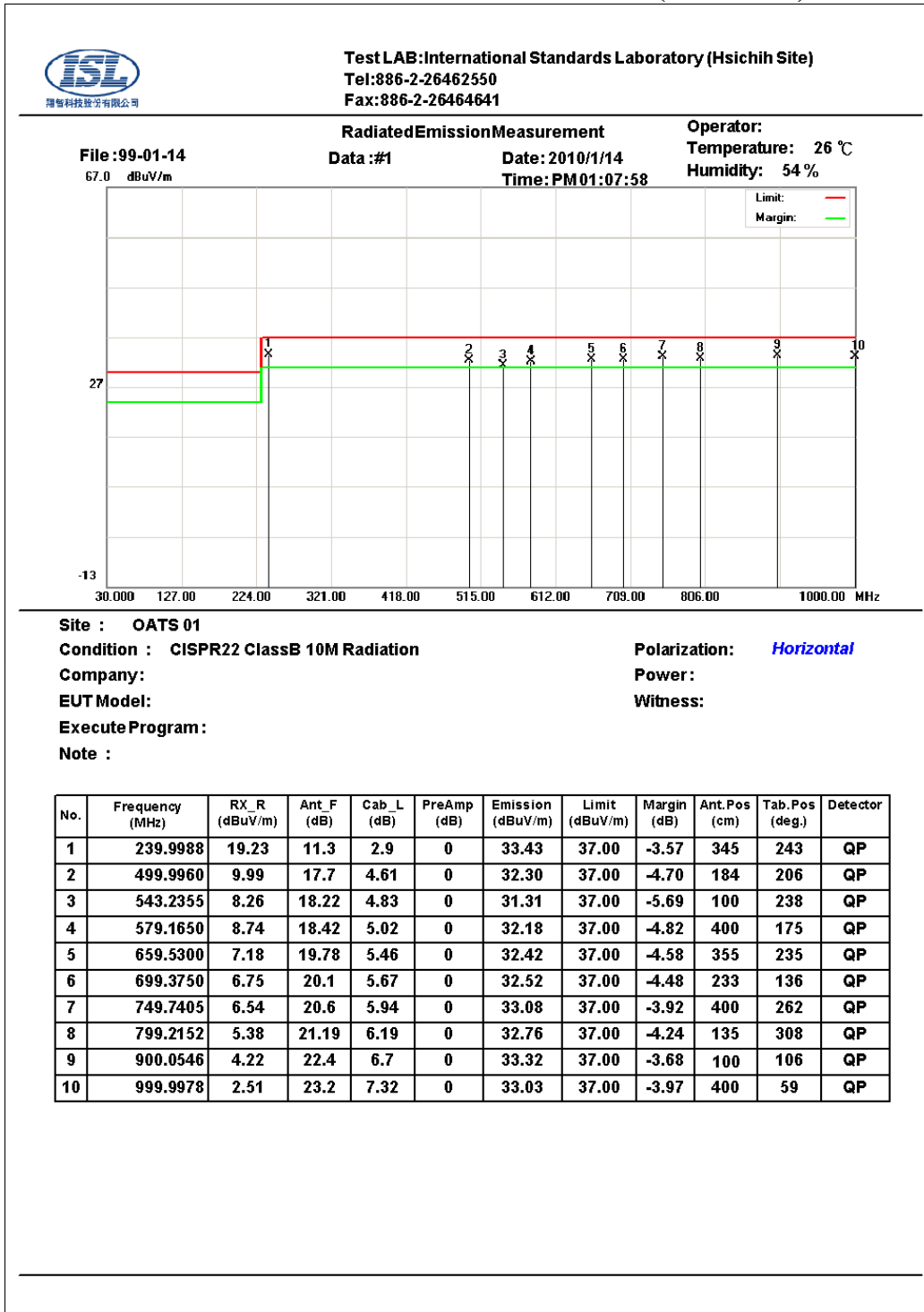

* Note:

Margin = Corrected Amplitude – Limit

Corrected Amplitude = Radiated Amplitude + Antenna Correction Factor + Cable Loss – Pre-Amplifier Gain

A margin of -8dB means that the emission is 8dB below the limit

BILOG Antenna Distance: 10 meter, Frequency: under 1000MHz

Below 1GHz test, if the peak measured value meets the QP limit, it is unnecessary to perform the QP measurement.

Table 7.2.1 Radiated Emissions (Vertical)

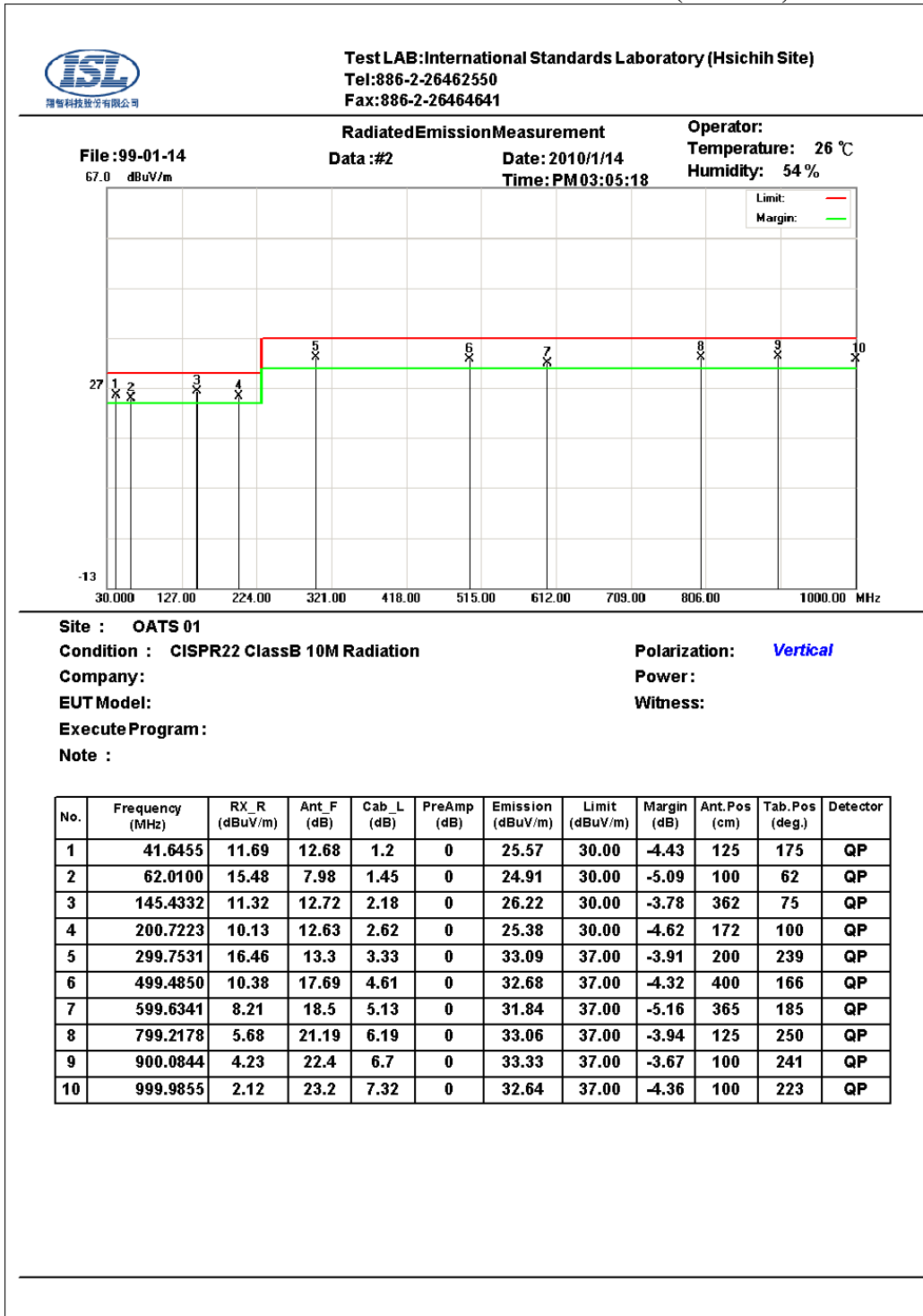

* Note:

Margin = Corrected Amplitude – Limit

Corrected Amplitude = Radiated Amplitude + Antenna Correction Factor + Cable Loss – Pre-Amplifier Gain

A margin of -8dB means that the emission is 8dB below the limit

BILOG Antenna Distance: 10 meter, Frequency: under 1000MHz

Below 1GHz test, if the peak measured value meets the QP limit, it is unnecessary to perform the QP measurement.

7.3 Radiation Test Data: Configuration 2

Table 7.3.1 Radiated Emissions (Horizontal)

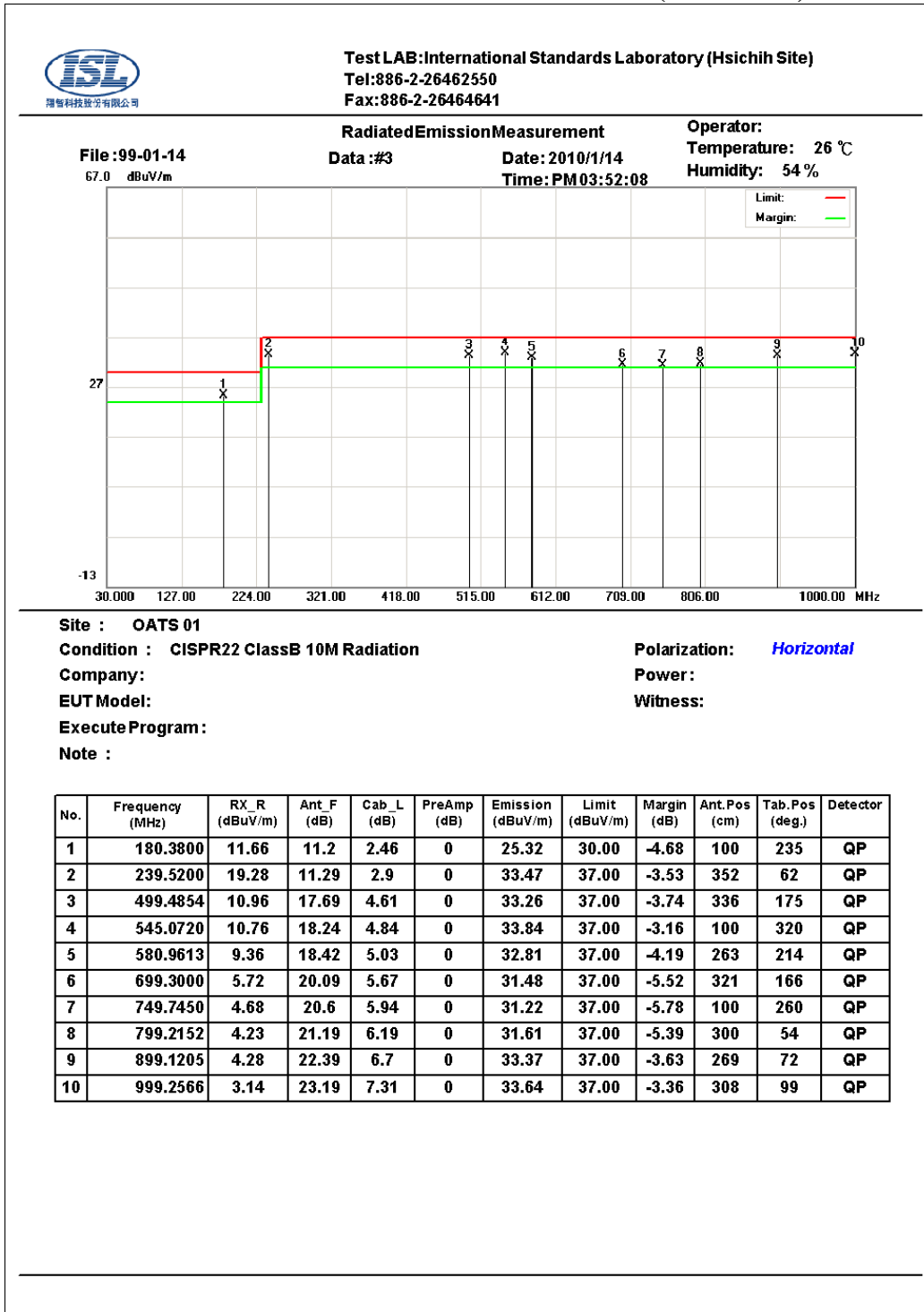

* Note:

Margin = Corrected Amplitude – Limit

Corrected Amplitude = Radiated Amplitude + Antenna Correction Factor + Cable Loss – Pre-Amplifier Gain

A margin of -8dB means that the emission is 8dB below the limit

BILOG Antenna Distance: 10 meter, Frequency: under 1000MHz

Below 1GHz test, if the peak measured value meets the QP limit, it is unnecessary to perform the QP measurement.

Table 7.3.1 Radiated Emissions (Vertical)

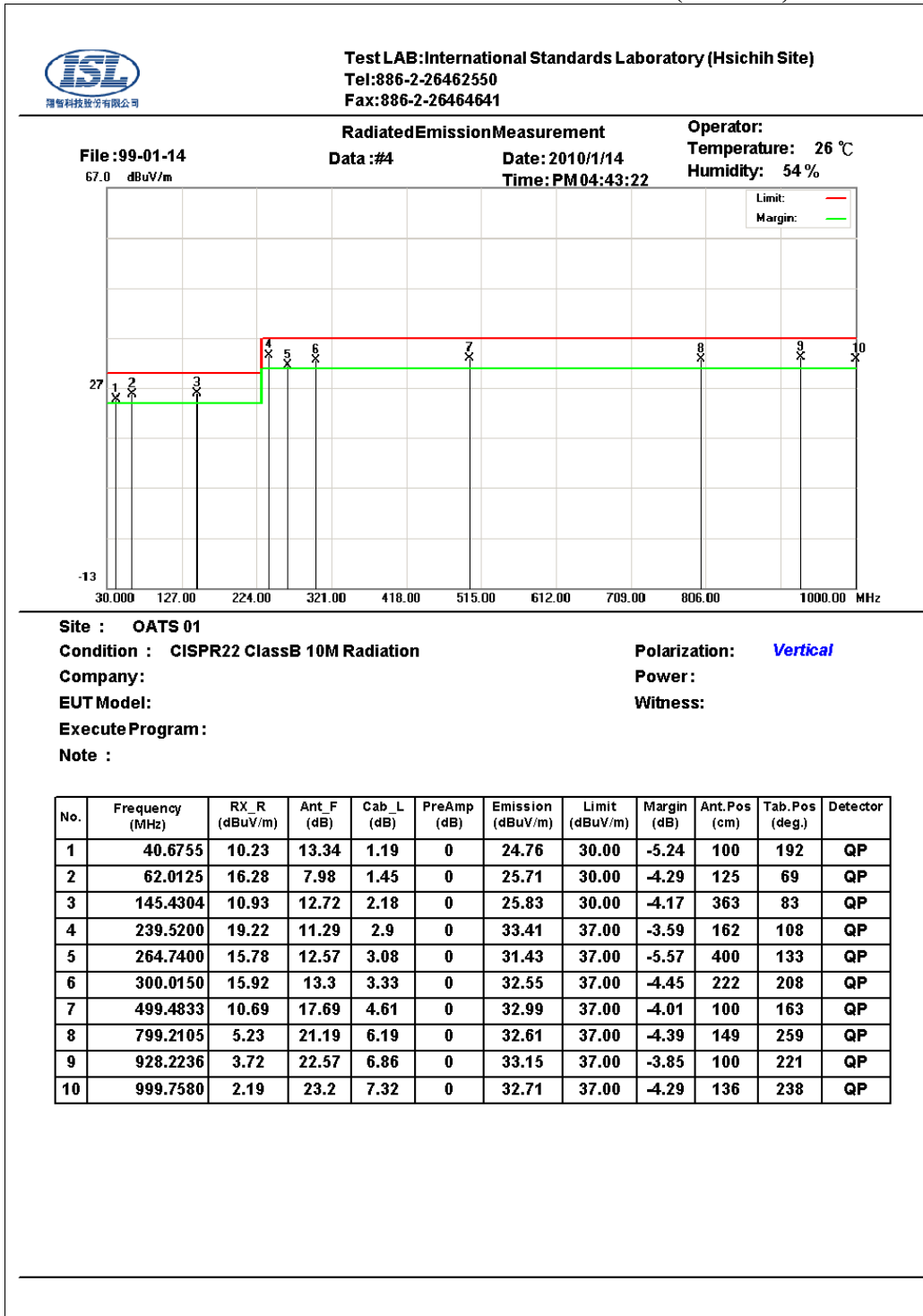

* Note:

Margin = Corrected Amplitude – Limit

Corrected Amplitude = Radiated Amplitude + Antenna Correction Factor + Cable Loss – Pre-Amplifier Gain

A margin of -8dB means that the emission is 8dB below the limit

BILOG Antenna Distance: 10 meter, Frequency: under 1000MHz

Below 1GHz test, if the peak measured value meets the QP limit, it is unnecessary to perform the QP measurement.

8. Electrostatic discharge (ESD) immunity

8.1 Electrostatic discharge (ESD) immunity test

Port:	Enclosure
Basic Standard:	EN 61000-4-2/ IEC EN61000-4-2 (details referred to Sec 2.2)
Test Level:	Air +/- 2 kV, +/- 4 kV, +/- 8 kV Contact +/- 2 kV, +/- 4 kV
Criteria:	B
Test Procedure	refer to ISL QA T04-S03
Temperature:	17 °C
Humidity:	54%

Selected Test Point

Air: discharges were applied to slots, aperture or insulating surfaces. 10 single air discharges were applied to each selected points.

Contact: Total 200 discharges minimum were to the selected contact points.

Indirect Contact Points: 25 discharges were applied to center of one edge of VCP and each EUT side of HCP with 10 cm away from EUT.

For final test points, please refer to EUT 26 to EUT 27 of “Appendix: Photographs of EUT”. Red arrow lines indicate the contact points, and blue arrow lines indicate the air points.

Test Setup

EUT is 1m from the wall and other metallic structure. When Battery test mode is needed, a cable with one 470KΩ resistor at two rare ends is connected from metallic part of EUT and screwed to HCP.

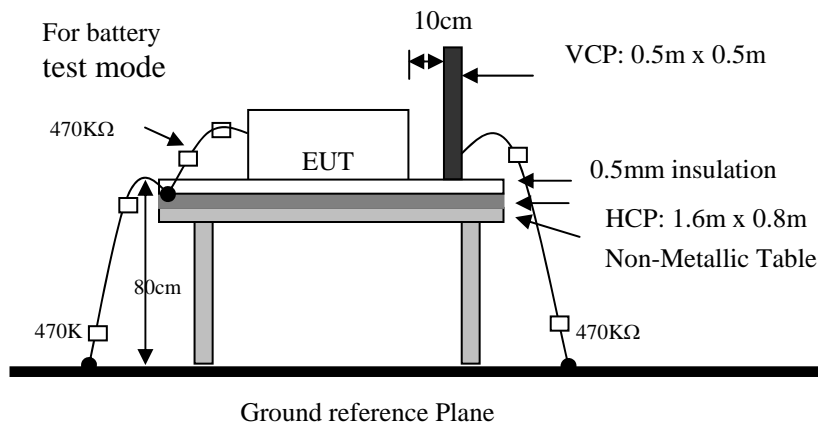

Test Result

Performance of EUT complies with the given specification.

9. Radio-Frequency, Electromagnetic Field immunity

9.1 Radio-Frequency, Electromagnetic Field immunity test

Port:	Enclosure
Basic Standard:	EN 61000-4-3/ IEC EN61000-4-3 (details referred to Sec 2.2)
Test Level::	3 V/m
Modulation:	AM 1KHz 80%
Frequency range:	80 MHz~1 GHz
Frequency Step:	1% of last step frequency
Dwell time:	3s
Polarization:	Vertical and Horizontal
EUT Azimuth Angle	<input checked="" type="checkbox"/> 0° <input checked="" type="checkbox"/> 90° <input checked="" type="checkbox"/> 180° <input checked="" type="checkbox"/> 270°
Criteria:	A
Test Procedure	refer to ISL QA T04-S107
Temperature:	20°C
Humidity:	65%

Test Setup

The field sensor is placed at one calibration grid point to check the intensity of the established fields on both polarizations. EUT is adjusted to have each side of EUT face coincident with the calibration plane. A CCD camera and speakers are used to monitor the condition of EUT for the performance judgment.

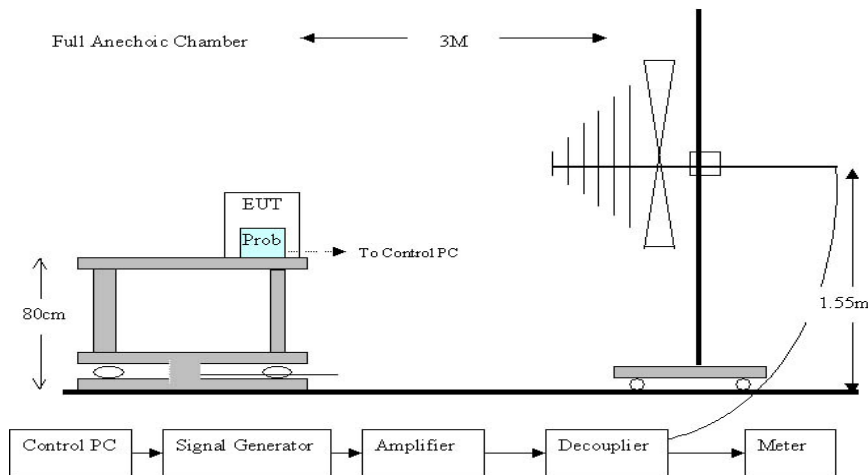

Test Result

Performance of EUT complies with the given specification.

10. Electrical Fast transients/burst immunity

10.1 Electrical Fast transient/burst immunity test

Port:	AC mains; Twisted Pair LAN Port
Basic Standard:	EN 61000-4-4/ IEC EN61000-4-4 (details referred to Sec 2.2)
Test Level:	AC Power Port: +/- 1 kV Twisted Pair LAN Port (I/O Cables): +/- 0.5 kV
Rise Time:	5ns
Hold Time:	50ns
Repetition Frequency:	5KHz
Criteria:	B
Test Procedure	refer to ISL QA T04-S05
Temperature:	17 °C
Humidity:	54%

Test Procedure

The EUT was setup on a nonconductive table 0.8 m above a reference ground plane.

Test Points	Polarity	Result	Comment
Line	+	N	60 sec
	-	N	60 sec
Neutral	+	N	60 sec
	-	N	60 sec
Ground	+	N	60 sec
	-	N	60 sec
Line to Neutral	+	N	60 sec
	-	N	60 sec
Line to Ground	+	N	60 sec
	-	N	60 sec
Neutral to Ground	+	N	60 sec
	-	N	60 sec
Line to Neutral to Ground	+	N	60 sec
	-	N	60 sec
Capacitive coupling clamp	+	N	60 sec
	-	N	60 sec

Note: 'N' means normal, the EUT function is correct during the test.

Test Setup

EUT is at least 50cm from the conductive structure.

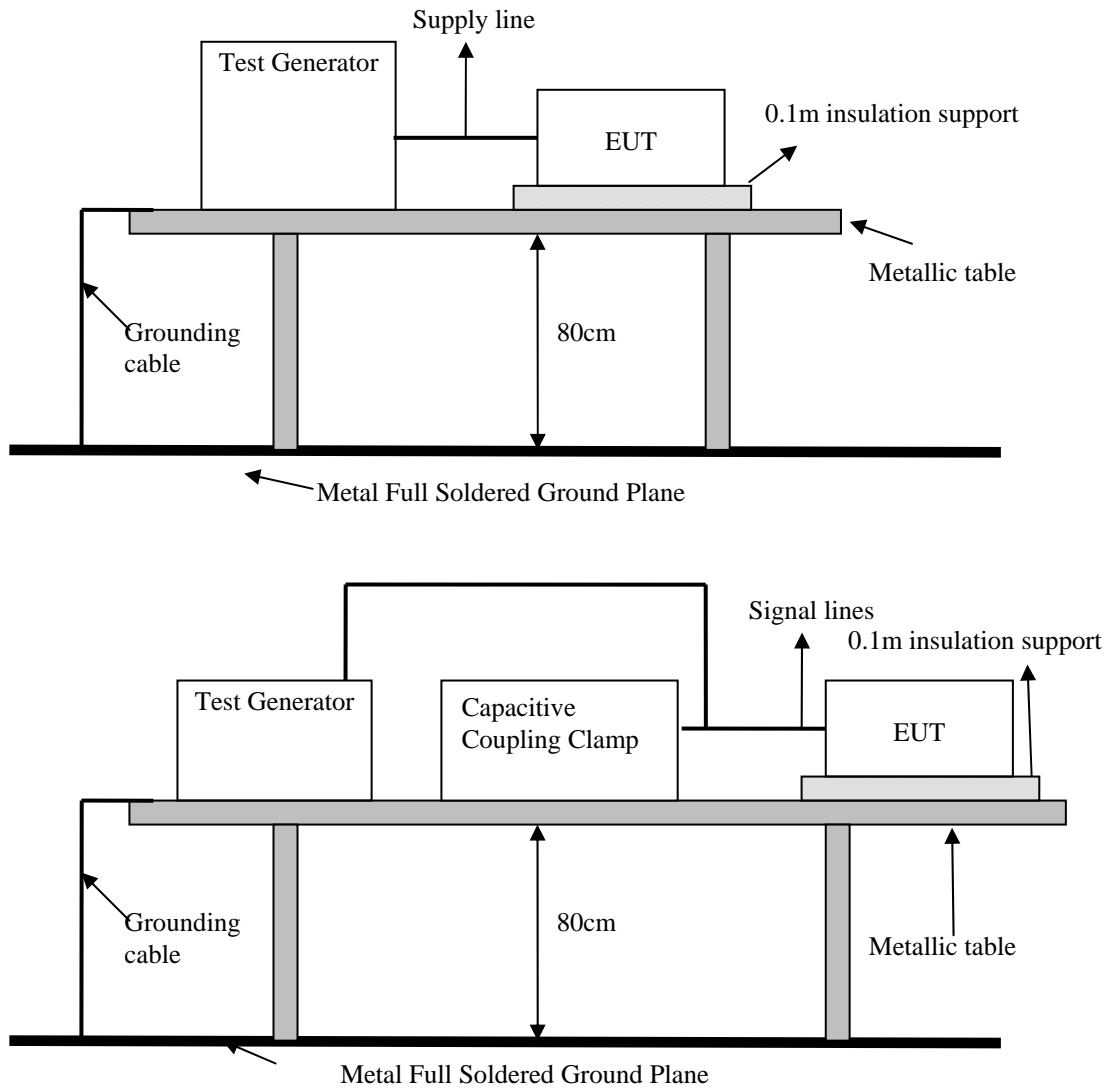

Test Result

Performance of EUT complies with the given specification.

11. Surge Immunity

11.1 Surge immunity test

Port:	AC mains
Basic Standard:	EN 61000-4-5/ IEC EN61000-4-5 (details referred to Sec 2.2)
Test Level:	AC Power Port: Line to Line: +/- 0.5 kV, +/- 1 kV Line to Earth: +/- 0.5 kV, +/- 1 kV, +/- 2kV
Rise Time:	1.2us
Hold Time:	50us
Repetition Rate:	30 second
Angle:	☒0° ☒90° ☒180° ☒270°
Criteria:	B
Test Procedure	refer to ISL QA T04-S04
Temperature:	17°C
Humidity:	54%

Test Setup

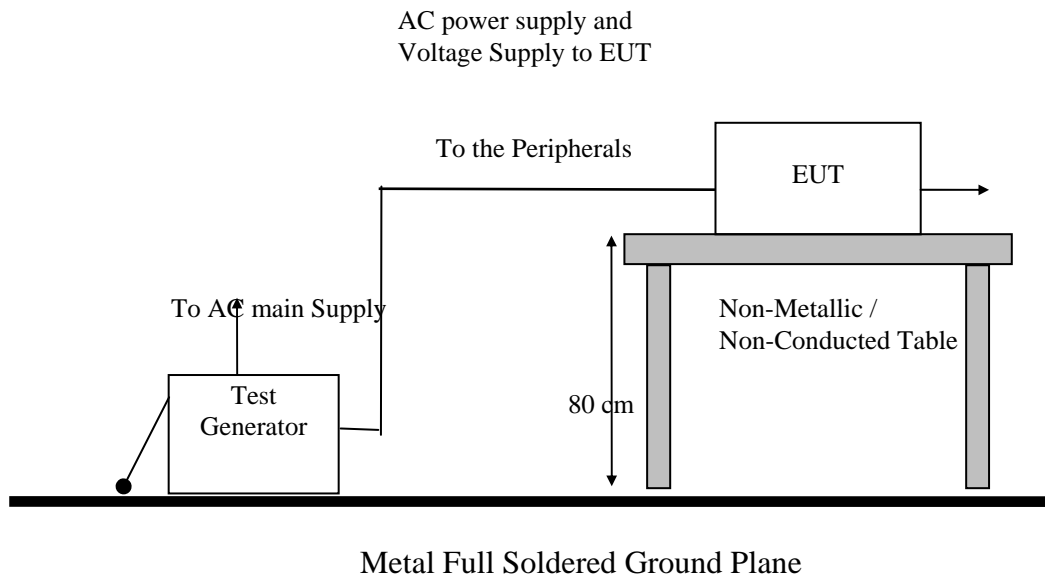

Test Result

Performance of EUT complies with the given specification.

13. Power Frequency Magnetic Field immunity

13.1 Power Frequency Magnetic field immunity test

Port:	Enclosure
Basic Standard:	EN 61000-4-8/ IEC EN61000-4-8 (details referred to Sec 2.2)
Test Level:	1A/m
Polarization:	X, Y, Z
Criteria:	A
Test Procedure	refer to ISL QA T04-S02
Temperature:	17°C
Humidity:	54%

Test Setup

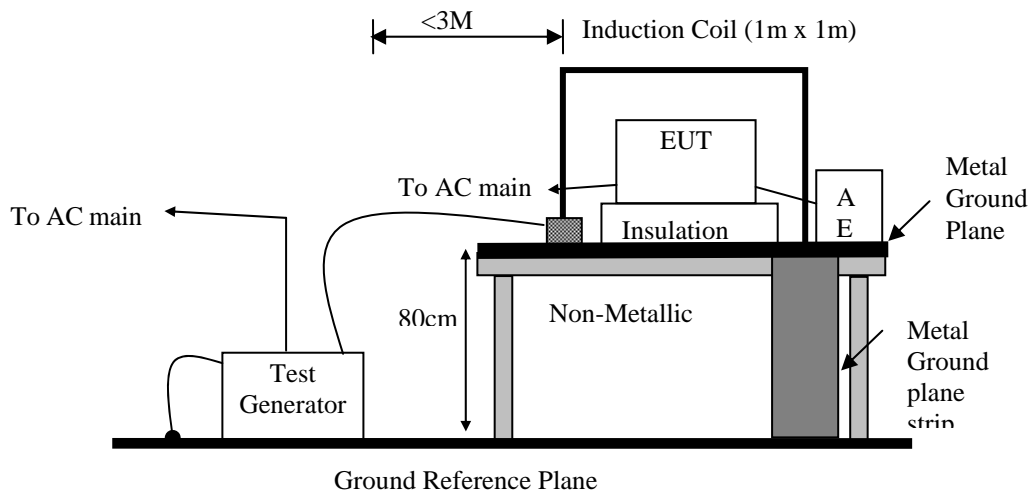

Test Result

Performance of EUT complies with the given specification.

14. Voltage Dips, Short Interruption and Voltage Variation immunity

14.1 Voltage Dips, Short Interruption and Voltage Variation immunity test

Port:	AC mains
Basic Standard:	EN 61000-4-11/ IEC EN61000-4-11 (details referred to Sec 2.2)
Test Level: Criteria:	>95% in 0.5 period B
Test Level: Criteria:	30% in 25 period C
Test Level: Criteria:	>95% in 250 period C
Phase:	0°; 180°
Test intervals:	3 times with 10s each
Test Procedure	refer to ISL QA T04-S108
Temperature:	17°C
Humidity:	54%

Test Setup

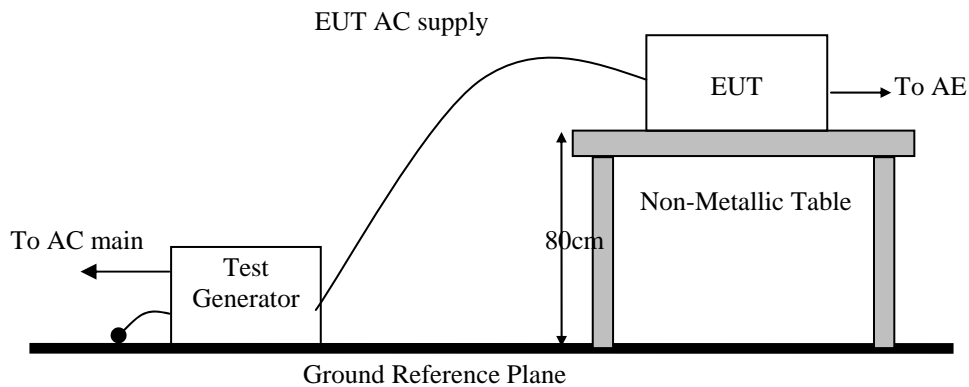

Test Result

Performance of EUT complies with the given specification.

15. Harmonics

15.1 Harmonics test

Port:	AC mains
Active Input Power:	>75W
Basic Standard:	EN61000-3-2/IEC 61000-3-2 (details referred to Sec 2.2)
Test Duration:	2.5min
Class:	D
Test Procedure	refer to ISL QA T04-S32
Temperature:	17°C
Humidity:	60%

Test Procedure

The EUT is supplied in series with shunts or current transformers from a source having the same nominal voltage and frequency as the rated supply voltage and frequency of the EUT. The EUT is configured to its rated current with additional resistive load when the testing is performed.

Equipment having more than one rated voltage shall be tested at the rated voltage producing the highest harmonics as compared with the limits.

Result

Active input power under 75W, no limit apply, declare compliance

Test Data

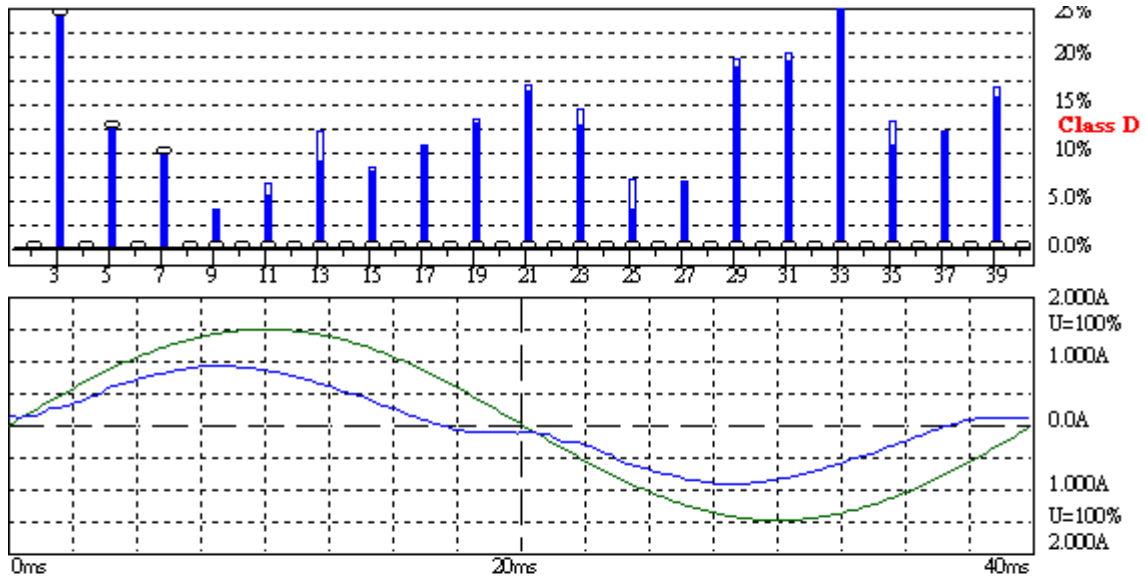

Harmonic Emission - IEC 61000-3-2, EN 61000-3-2, (EN60555-2)

2010/1/21 PM 01:38:2

U _{rms} =	229.9	V	P =	122.4	W	THC =	0.114	A
I _{rms} =	0.569	A	pf =	0.935		P _{max} =	127.5	W

Range:	2 A
V-nom:	230 V
TestTime:	5 min (100%)

Test completed, Result: PASSED

HAR-1000 EMC-Return

Urms = 229.9V Freq = 50.000 Range: 2 A
 Irms = 0.569A Ipk = 0.921A cf = 1.617
 P = 122.4W S = 130.9VA pf = 0.935
 THDi = 20.0 % THDu = 0.20 % Class D
 Test - Time : 5min (100 %)
 Limit Reference: Pmax = 127.55W

Test completed, Result: PASSED

Order	Freq. [Hz]	Iavg [A]	Iavg%L [%]	Irms [A]	Irms%L [%]	Imax [A]	Imax%L [%]	Limit [A]	Status
1	50	0.5617		0.5580		0.5796			
2	100	0.0000		0.0004		0.0007			
3	150	0.1091	25.165	0.1085	25.024	0.1108	25.559	0.4337	
4	200	0.0000		0.0004		0.0005			
5	250	0.0307	12.665	0.0304	12.542	0.0315	12.996	0.2423	
6	300	0.0000		0.0004		0.0005			
7	350	0.0126	9.8595	0.0125	9.7619	0.0128	10.049	0.1275	
8	400	0.0000		0.0002		0.0002			
9	450	0.0000	0.0000	0.0024	3.8282	0.0024	3.8282	0.0638	
10	500	0.0000		0.0001		0.0001			
11	550	0.0000	0.0000	0.0023	5.1954	0.0029	6.5626	0.0446	
12	600	0.0000		0.0002		0.0002			
13	650	0.0000	0.0000	0.0033	8.7253	0.0045	11.957	0.0378	
14	700	0.0000		0.0002		0.0002			
15	750	0.0000	0.0000	0.0026	7.8304	0.0027	8.2033	0.0327	
16	800	0.0000		0.0001		0.0002			
17	850	0.0000	0.0000	0.0031	10.565	0.0031	10.565	0.0289	
18	900	0.0000		0.0002		0.0002			
19	950	0.0000	0.0000	0.0033	12.752	0.0034	13.225	0.0258	
20	1000	0.0000		0.0002		0.0002			
21	1050	0.0000	0.0000	0.0038	16.183	0.0039	16.705	0.0234	
22	1100	0.0000		0.0002		0.0002			
23	1150	0.0000	0.0000	0.0027	12.578	0.0031	14.294	0.0214	
24	1200	0.0000		0.0002		0.0002			
25	1250	0.0000	0.0000	0.0007	3.7288	0.0013	6.8361	0.0196	
26	1300	0.0000		0.0002		0.0002			
27	1350	0.0000	0.0000	0.0012	6.7118	0.0012	6.7118	0.0182	
28	1400	0.0000		0.0002		0.0002			
29	1450	0.0000	0.0000	0.0032	18.743	0.0033	19.464	0.0169	
30	1500	0.0000		0.0002		0.0002			
31	1550	0.0000	0.0000	0.0031	19.265	0.0032	20.036	0.0158	
32	1600	0.0000		0.0002		0.0002			
33	1650	0.0000	0.0385	0.0049	32.813	0.0050	33.633	0.0149	
34	1700	0.0000		0.0002		0.0002			
35	1750	0.0000	0.0000	0.0015	10.441	0.0018	13.051	0.0140	
36	1800	0.0000		0.0002		0.0004			
37	1850	0.0000	0.0000	0.0016	11.957	0.0016	11.957	0.0133	
38	1900	0.0000		0.0002		0.0002			
39	1950	0.0000	0.0000	0.0020	15.512	0.0021	16.481	0.0126	
40	2000	0.0000		0.0002		0.0004			

16. Voltage Fluctuations

16.1 Voltage Fluctuations test

Port:	AC mains
Basic Standard:	EN61000-3-3/IEC61000-3-3 (details referred to Sec 2.2)
Test Procedure	refer to ISL QA T04-S32
Observation period:	For Pst 10min
	For Plt 2 hours
Temperature:	17°C
Humidity:	60%

Test Procedure

The EUT is supplied in series with reference impedance from a power source with the voltage and frequency as the nominal supply voltage and frequency of the EUT.

Result

Performance of EUT complies with the given specification.

Test Data

10min

Flickermeter 1000-4-15 for 230V/50Hz

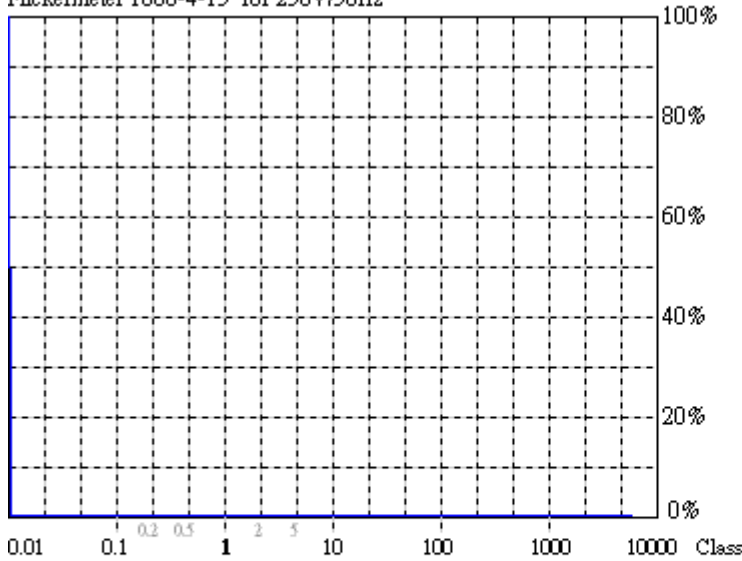

Actual Flicker (Fli): 0.00
Short-term Flicker (Pst): 0.07
 Limit (Pst): 1.00
Long-term Flicker (Plt): 0.07
 Limit (Plt): 0.65
Maximum Relative Volt. Change (dmax): 0.00%
 Limit (dmax): 4.00%
Relative Steady-state Voltage Change (dc): 0.00%
 Limit (dc): 3.30%
Maximum Interval exceeding 3.30% (dt): 0.00ms
 Limit (dt>Lim): 500ms

Flicker Emission - IEC 61000-3-3 , EN 61000-3-3 , (EN60555-3)

2010/1/21 PM 01:50:4

U_{rms} = 229.7 V P = 122.0 W
 I_{rms} = 0.568 A pf = 0.935

Range: 2 A
 V_{nom}: 230 V
 TestTime: 10 min (100%)

Test completed, Result: PASSED

Flickermeter 1000-4-15 for 230V/50Hz

HAR-1000 EMC-Retrie

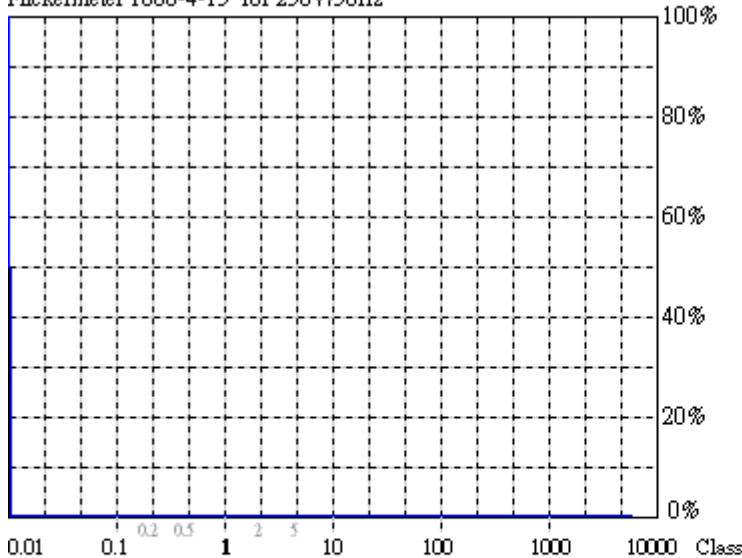

Actual Flicker (Fli): 0.00
Short-term Flicker (Pst): 0.07
 Limit (Pst): 1.00
Long-term Flicker (Plt): 0.07
 Limit (Plt): 0.65
Maximum Relative Volt. Change (dmax): 0.00%
 Limit (dmax): 4.00%
Relative Steady-state Voltage Change (dc): 0.00%
 Limit (dc): 3.30%
Maximum Interval exceeding 3.30% (dt): 0.00ms
 Limit (dt>Lim): 500ms

Flicker Emission - IEC 61000-3-3 , EN 61000-3-3 , (EN60555-3)

2010/1/21 PM 08:53:0

U_{rms} = 229.9 V P = 122.4 W
 I_{rms} = 0.569 A pf = 0.935

Range: 2 A
 V_{nom}: 230 V
 TestTime: 120 min (10000%)

Test completed, Result: PASSED

HAR-1000 EMC-Retrie

17. Appendix

17.1 Appendix A: Measurement Procedure for Main Power Port Conducted Emissions

The measurements are performed in a 3.5m x 3.4m x 2.5m shielded room, which referred as Conduction 01 test site, or a 3m x 3m x 2.3m test site, which referred as Conduction 02 test site. The EUT was placed on non-conduction 1.0m x 1.5m table, which is 0.8 meters above an earth-grounded.

Power to the EUT was provided through the LISN which has the Impedance (50ohm/50uH) vs. Frequency Characteristic in accordance with the standard. Power to the LISNs were filtered to eliminate ambient signal interference and these filters were bonded to the ground plane. Peripheral equipment required to provide a functional system (support equipment) for EUT testing was powered from the second LISN through a ganged, metal power outlet box which is bonded to the ground plane at the LISN.

If the EUT is supplied with a flexible power cord, the power cord length in excess of the distance separating the EUT from the LISN shall be folded back and forth at the center of the lead so as to form a bundle not exceeding 40cm in length. If the EUT is provided with a permanently coiled power cord, bundling of the cord is not required. If the EUT is supplied without a power cord, the EUT shall be connected to the LISN by a power cord of the type specified by the manufacturer which shall not be longer than 1 meter. The excess power cord shall be bundled as described above. If a non-flexible power cord is provided with the EUT, it shall be cut to the length necessary to attach the EUT to the LISN and shall not be bundled.

The interconnecting cables were arranged and moved to get the maximum measurement. Both the line of power cord, hot and neutral, were measured.

The highest emissions were analyzed in details by operating the spectrum analyzer in fixed tuned mode to determine the nature of the emissions and to provide information which could be useful in reducing their amplitude.

17.2 Appendix B: Measurement Procedure for Telecommunication Port Conducted Emissions

The measurements are performed in a 3.5m x 3.4m x 2.5m shielded room, which referred as Conduction 01 test site, or a 3m x 3m x 2.3m test site, which referred as Conduction 02 test site. The EUT was placed on non-conduction 1.0m x 1.5m table, which is 0.8 meters above an earth-grounded.

The EUT, any support equipment, and any interconnecting cables were arranged and moved to get the maximum measurement.

Power to the EUT was provided through the LISN which has the Impedance (50 Ohm/50uH) vs. Frequency Characteristic in accordance with the standard. Power to the LISN was filtered to eliminate ambient signal interference and this filter was bonded to ground. Peripheral equipment to provide a functional system (support equipment) for EUT testing was powered through a ganged, metal power outlet box bonded to the ground. AC input power for the auxiliary power outlets was obtained from the same filtered source that provides input power to the LISN.

If the EUT is supplied with a flexible power cord, if the power cord length in excess of 1 m, the excess cable shall be bundled at approximate center of the power cord with the bundles 30 cm to 40 cm in length. If the EUT is provided with a permanently coiled power cord, bundling of the cord is not required. If the EUT is supplied without a power cord, the EUT shall be connected to the LISN by a power cord of the type specified by the manufacturer which shall be 1 meter in length. If a non-flexible power cord is provided with the EUT, it shall be cut to the length necessary to attach the EUT to the LISN and shall not be bundled.

The highest emissions were analyzed in details by operating the spectrum analyzer in fixed tuned mode to determine the nature of the emissions and to provide information could be useful in reducing their amplitude.

17.3 Appendix C: Test Procedure for Radiated Emissions

Preliminary Measurements in the Anechoic Chamber

The radiated emissions are initially measured in the anechoic chamber at a measurement distance of 10 (or 3) meters. Desktop EUT are placed on a wooden stand 0.8 meter in height. The measurement antenna is 10 (or 3) meters from the EUT. The test setup in anechoic chamber is the same as open site. The turntable rotated 360°. The antenna height is varied from 1-2.5m. The primary objective of the radiated measurements in the anechoic chamber is to identify the frequency spectrum in the absence of the electromagnetic environment existing on the open test site. The frequencies can then be pre-selected on the open test site to obtain the corresponding amplitude. The initial scan is made with the spectrum analyzer in automatic sweep mode. The spectrum peaks are then measured manually to determine the exact frequencies.

Measurements on the Open Site or Chamber

The radiated emissions test will then be repeated on the open site or chamber to measure the amplitudes accurately and without the multiple reflections existing in the shielded room. The EUT and support equipment are set up on the turntable of one of 10 meter open field sites. Desktop EUT are set up on a wooden stand 0.8 meter above the ground.

For the initial measurements, the receiving antenna is varied from 1-4 meter height and is changed in the vertical plane from vertical to horizontal polarization at each frequency. The highest emissions between 30 MHz to 1000 MHz were analyzed in details by operating the spectrum analyzer and/or EMI receiver in quasi-peak mode to determine the precise amplitude of the emissions. The highest emissions between 1 GHz to 6 GHz were analyzed in details by operating the spectrum analyzer in peak and average mode to determine the precise amplitude of the emissions.

At the highest amplitudes observed, the EUT is rotated in the horizontal plane while changing the antenna polarization in the vertical plane to maximize the reading. The interconnecting cables were arranged and moved to get the maximum measurement. Once the maximum reading is obtained, the antenna elevation and polarization will be varied between specified limits to maximize the readings.

17.4 Appendix D: Test Equipment

17.4.1 Test Equipment List

Location	Equipment Name	Brand	Model	S/N	Last Cal. Date	Next Cal. Date
Conduction	Coaxial Cable 1F-C1	Harbourindustries	RG400	1F-C1	10/23/2009	10/23/2010
Conduction	LISN 02	EMCO	3825/2	1407	07/14/2009	07/14/2010
Conduction	LISN 03	R&S	ESH3-Z5 831.5518.52	828874/010	07/14/2009	07/14/2010
Conduction	ISN T2 03	FCC	FCC-TLISN-T 2-02	20618	08/11/2009	08/11/2010
Conduction	ISN T4 05	FCC	FCC-TLISN-T 4-02	20619	08/11/2009	08/11/2010
Conduction	ISN T8 03	FCC	FCC-TLINS-T 8-02	20620	08/11/2009	08/11/2010
Conduction	EMI Receiver 08	Schwarzbeck Mess-Elektronik	FCKL 1528	1528-202	09/10/2009	09/10/2010
Conduction	Spectrum Analyzer 05	HP	8594EM	3619A00192	02/23/2009	02/23/2010
Radiation	BILOG Antenna 10	Sumol Sciences	JB1	A013004-1	07/24/2009	07/24/2010
Radiation	Coaxial Cable 3F-10M	MIYAZAKI	8D-8F	10M-1	10/23/2009	10/23/2010
Radiation	Coaxial Cable 3F-3M	BELDEN	RG-8/U	3F-3M	10/23/2009	10/23/2010
Radiation	Spectrum Analyzer 12	Advantest	R3132	130200208	03/05/2009	03/05/2010
Radiation	EMI Receiver 09	Schwarzbeck Mess-Elektronik	FCVU 1534	1534-150	05/12/2009	05/12/2010

Location	Equipment Name	Brand	Model	S/N	Last Cal. Date	Next Cal. Date
EN61K-3-2/3	DC Burn-In Load 02	D-RAM	DBS-2100	2100-910027	N/A	N/A
EN61K-3-2/3	Harmonic/Flicker Test System 03	EMC Partner	HARMONICS-1000	178	03/27/2009	03/27/2010
EN61K-4-,4,5,8,11	TRANSIENT 2000 01	EMC Partner	TRANSIENT-2000	950	12/01/2009	12/01/2010
EN61K-4-2	ESD GUN 04	Schaffner	NSG 438	489	03/09/2009	03/09/2010
EN61K-4-3	BILOG Antenna 06	Schaffner	CBL6112B	2754	N/A	N/A
EN61K-4-3	Amplifier 80Mz~1GHz 250W	AR	250W1000A	312494	N/A	N/A
EN61K-4-3	Amplifier 800MHz~3.0GHz 60W	AR	60S1G3	312762	N/A	N/A
EN61K-4-3	Broadband coupler 10K~220Mhz	Amplifier Research	DC2500	19810	N/A	N/A
EN61K-4-3	Broadband Coupler 80M~1GHz	Amplifier Research	DC6180	20364	N/A	N/A
EN61K-4-3	Broadband Coupler 1~4GHz	Werlatone	C5291	6516	N/A	N/A
EN61K-4-3	Coaxial Cable Chmb 04-3M-2	Belden	RG-8/U	Chmb 04-3M-2	N/A	N/A
EN61K-4-3	Signal Generator 03	Anritsu	MG3642A	6200162550	02/27/2009	02/27/2010
EN61K-4-4	Digital Oscilloscope	Tektronix	TDS 684A	B010761	N/A	N/A
EN61K-4-4	EFT Clamp	Precision	1604242	CNEFT1000-103	N/A	N/A
EN61K-4-5	CDN-UTP8 01	EMC Partner	CDN-UTP8	032	12/01/2009	12/01/2010
EN61K-4-5	SURGE-TESTER 01	EMC Partner	MIG0603IN3	778	12/01/2009	12/01/2010
EN61K-4-6	6dB Attenuator	Weinschel Corp	33-6-34	BC5975	N/A	N/A
EN61K-4-6	Amplifier 4-6	Amplifier Research	150A100	1-1-R-02157	N/A	N/A
EN61K-4-6	Attenuator 6dB 4-6	BIRO	100-A-FFN-06	0123	N/A	N/A
EN61K-4-6	CDN M2+M3	Frankonia	M2+M3	A3011016	07/15/2009	07/15/2010
EN61K-4-6	CDN T2 01	Frankonia	T2	A3010003	07/16/2009	07/16/2010
EN61K-4-6	CDN T4 05	FCC Inc.	FCC-801-T4-RJ45	08020	08/11/2009	08/11/2010
EN61K-4-6	CDN T8 01	FCC Inc.	FCC-801-T8-RJ45	08021	08/11/2009	08/11/2010
EN61K-4-6	EM-Clamp 01	FCC	F-203I-23M M	539	N/A	N/A
EN61K-4-6	Coaxial Cable 4-6 01-1	Harbour Industries	M17/128-RG 400	4-6 01-1	N/A	N/A
EN61K-4-6	Coaxial Cable 4-6 01-2	Harbour Industries	M17/128-RG 400	4-6 01-2	N/A	N/A
EN61K-4-6	Coaxial Cable 4-6 01-3	Harbour Industries	M17/128-RG 400	4-6 01-3	N/A	N/A
EN61K-4-6	KAL-AD RJ45S	BIRO			N/A	N/A
EN61K-4-6	KAL-AD T2	BIRO			N/A	N/A

EN61K-4-6	Passive Impedance Adaptor 4-6	FCC	FCC-801-150-50-CDN	9758;9759	N/A	N/A
EN61K-4-6, CISPR 13, Antenna	Signal Generator 01	HP	8656B	2635A04675	08/21/2009	08/21/2010
EN61K-4-8	Clamp Meter 4-8	TES	3090	990900322	07/23/2009	07/23/2010
EN61K-4-8	Magnetic Field Antenna	Precision	TRAIZ44B	MF1000-23	N/A	N/A

17.5 Software for Controlling Spectrum/Receiver and Calculating Test Data

Test Item	Filename	Version
EN61000-3-2	HARCS.EXE	4.16
EN61000-3-3	HARCS.EXE	4.16
EN61000-4-3	Tile.Exe	2.0.P
EN61000-4-6	EN61000-4-6 Application Software	1.13.e
EN61000-4-2	N/A	2.0
EN61000-4-4	Tema.EXE	1.69
EN61000-4-5	Tema.EXE	1.69
EN61000-4-8	N/A	
EN61000-4-11	VDS-2002Rs.EXE	2.00

Radiation/Conduction	Filename	Version	Issued Date
Hsichih Conduction	EZ EMC	1.1.4.2	2/10/2007
Hsichih Radiation	EZ EMC	1.1.4.2	1/24/2007

17.6 Appendix E: Layout of EUT and Support Equipment

17.6.1 General Power Main Port Conducted Test Configuration

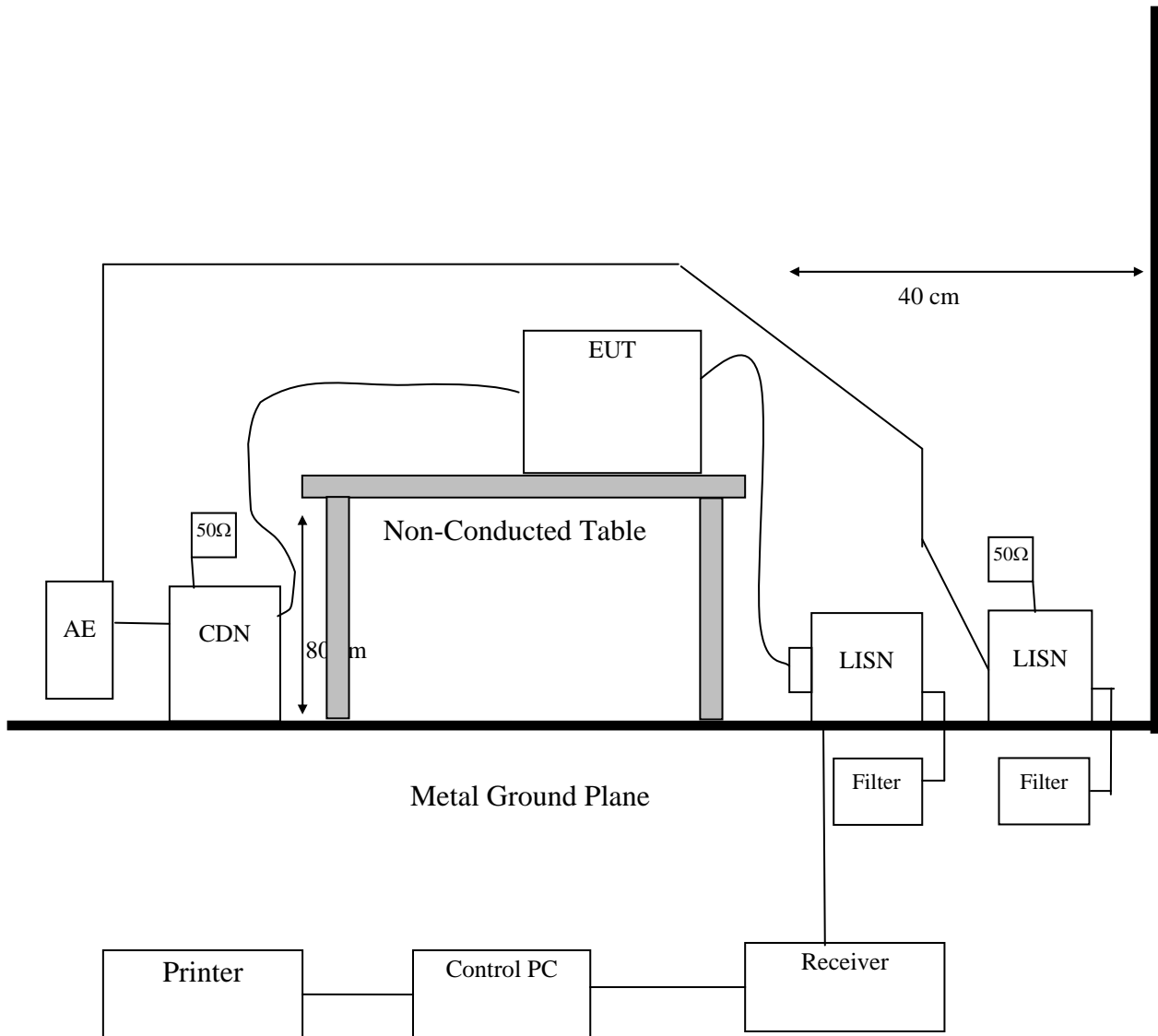

17.6.2 General Telecommunication Port Conducted Emission Test Configuration

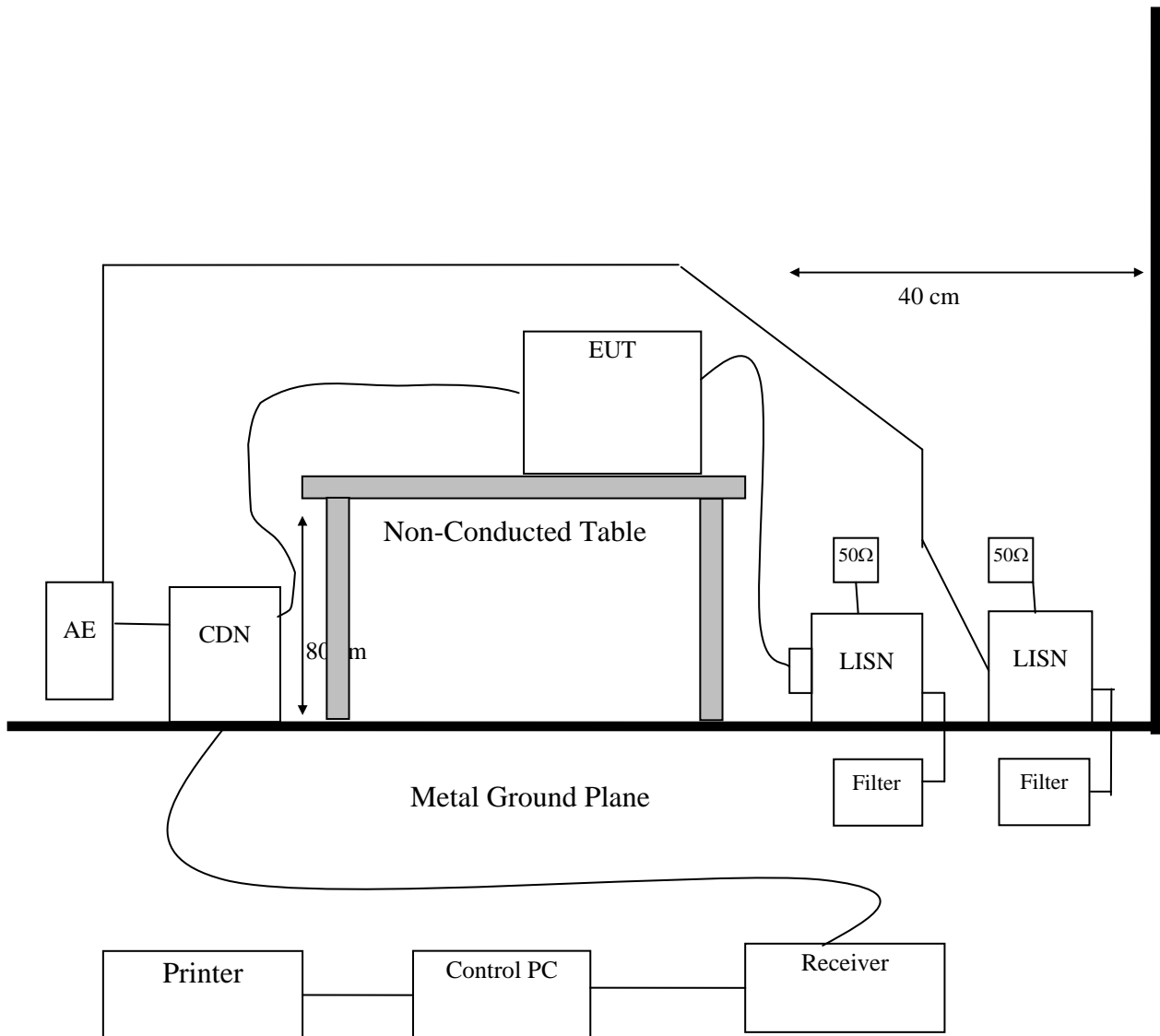

17.6.3 General Radiation Test Configuration <30MHz-1000MHz>

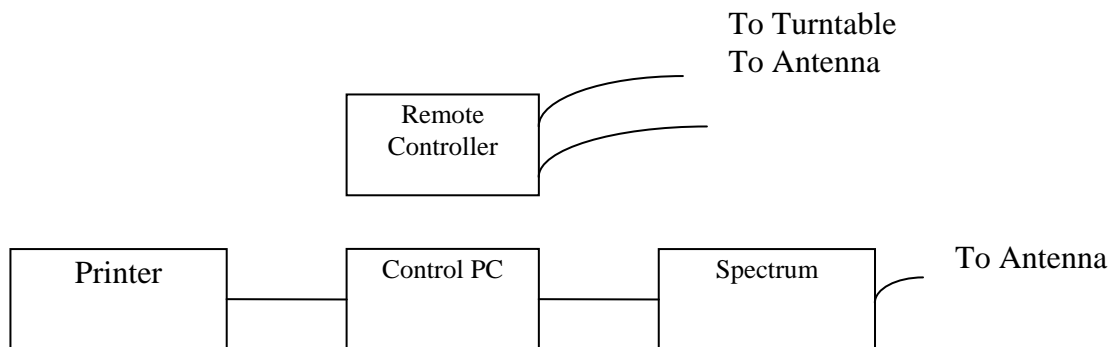
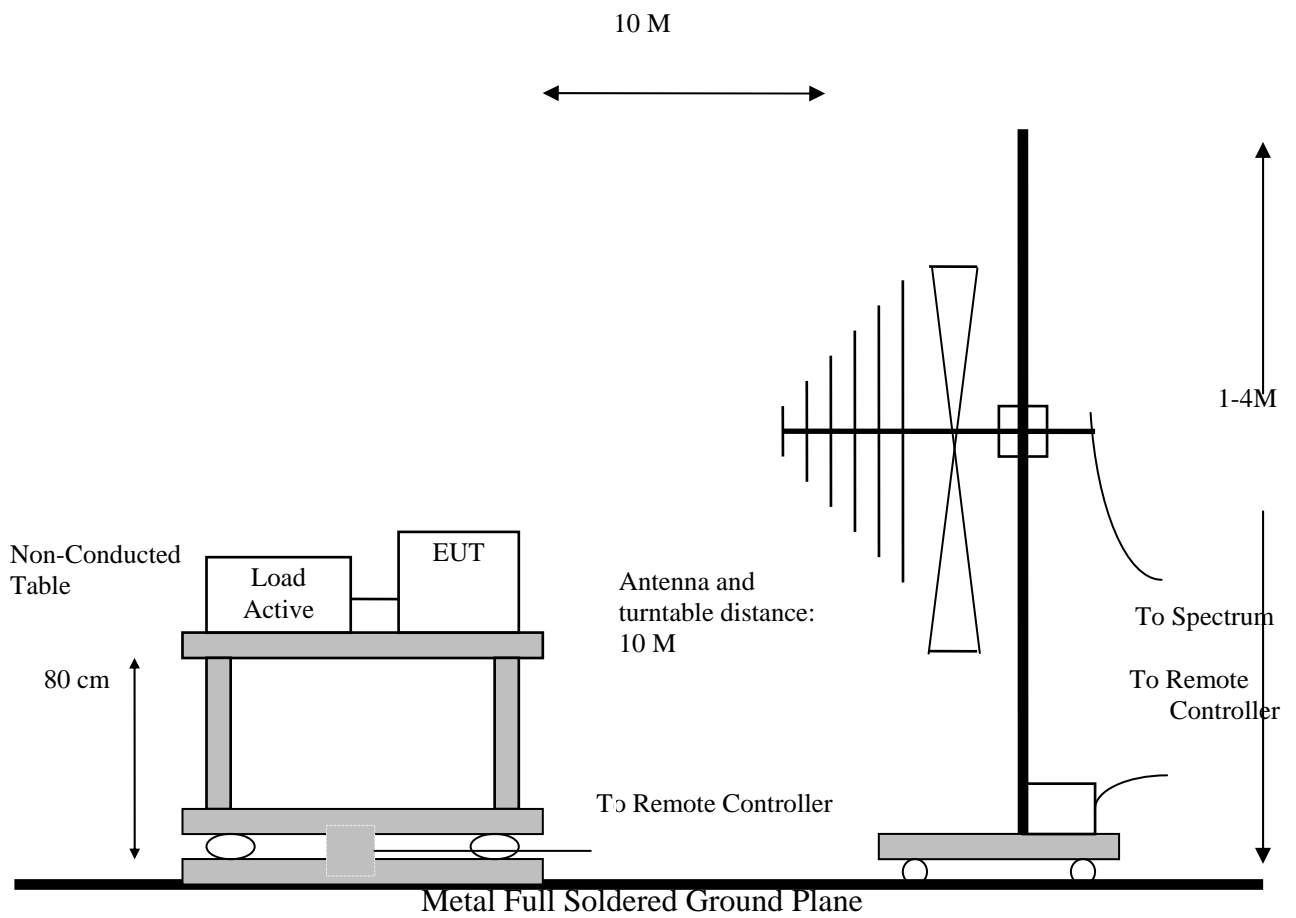

17.7 Appendix F: Uncertainty of Measurement

The measurement uncertainty refers to CISPR 16-4-2:2003. The coverage factor $k = 2$ yields approximately a 95 % level of confidence.

<Conduction 01> $\pm 2.946\text{dB}$

<OATS 01 (10M)>

30MHz~1GHz: $\pm 4.147\text{dB}$

<Immunity 01>

Test item	Uncertainty
EN61000-4-2 (ESD)	
Voltage	$\pm 1.848\%$
First Peak current	$\pm 3.233\%$
current at 30ns	$\pm 0.5\%$
current at 60ns	$\pm 0.970\%$
EN61000-4-3 (RS)	$\pm 1.776\text{dB}$
EN61000-4-4 (EFT)	
Time	$\pm 3.162\%$
Voltage	$\pm 4.624\%$
EN61000-4-5 (Surge)	
Time	$\pm 0.200\%$
Voltage	$\pm 4.041\%$
Current	$\pm 3.464\%$
EN61000-4-6 (CS)	$\pm 1.892\text{dB}$
EN61000-4-8 (Magnetic)	$\pm 0.099\%$
EN61000-4-11 (Dips)	
Time	$\pm 0.115\%$
Voltage	$\pm 4.041\%$
Current	$\pm 3.646\%$
EN61000-3-2 (Harmonics)	$\pm 0.320\%$
EN61000-3-3 (Fluctuations and Flicker)	$\pm 0.320\%$

17.8 Appendix G: Photographs of EUT Configuration Test Set Up

17.8.1 Photo of Main Power Port Conducted Emission and Telecommunication Port Conducted Emission Measurement

Front View (Configuration 1)



Front View (Configuration 2)



Back View (Configuration 1)

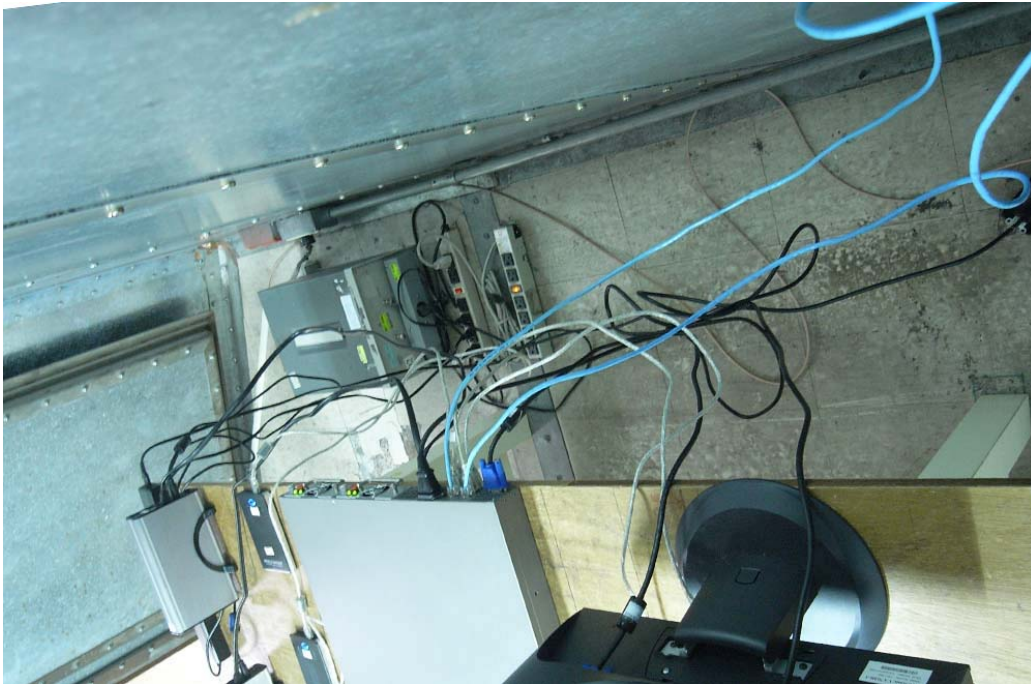

Back View (Configuration 2)

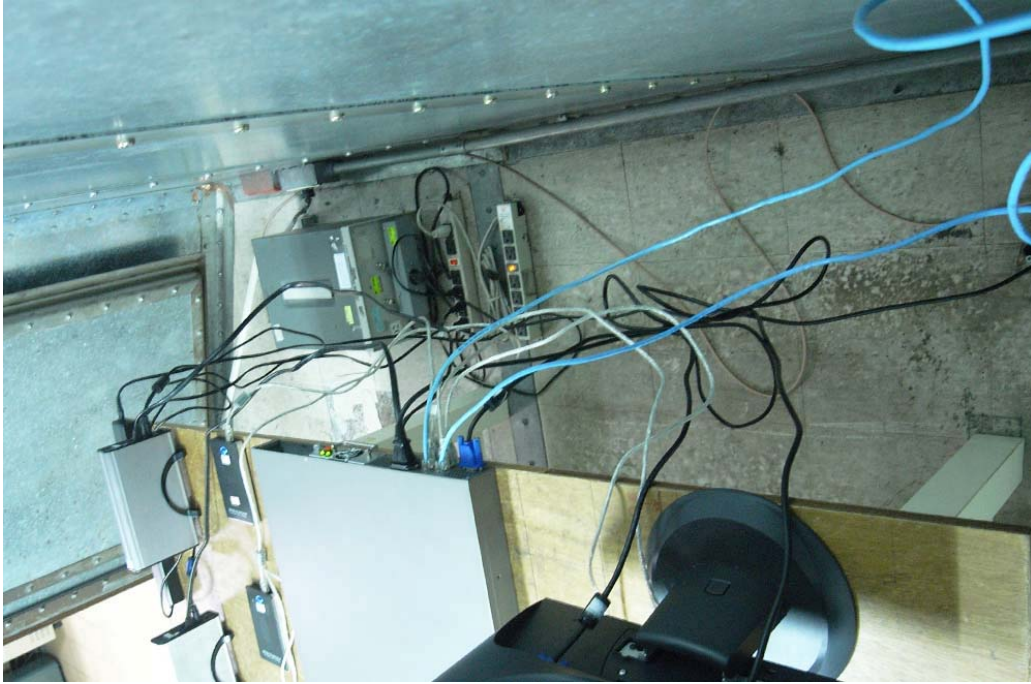

17.8.2 Photo of Radiated Emission Measurement

Front View (Configuration 1)



Back View



Front View (Configuration 2)



Back View

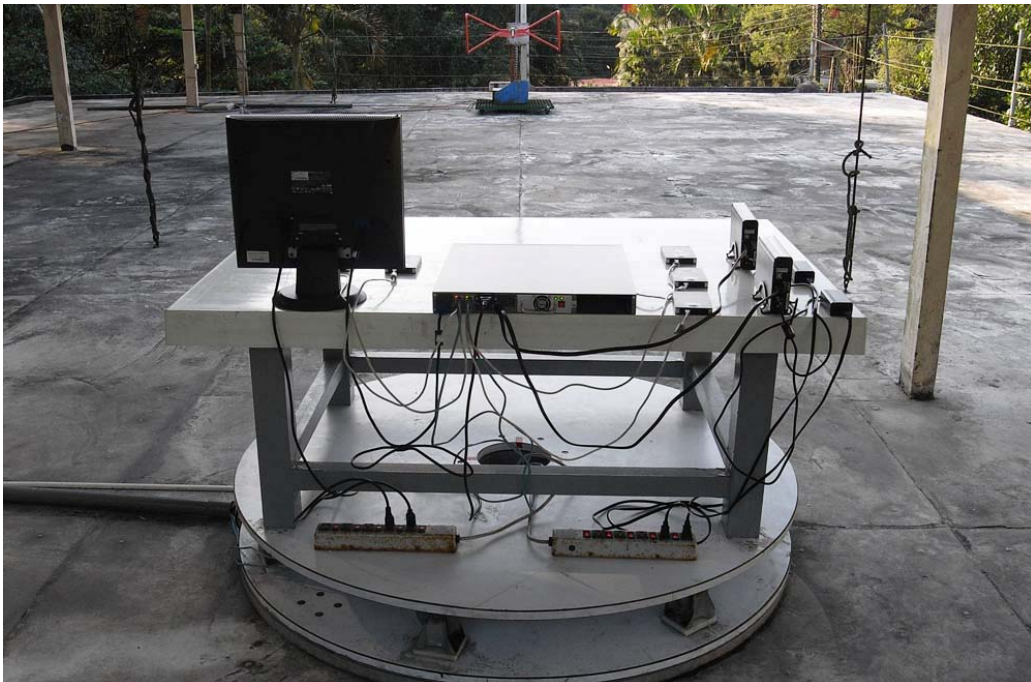

17.8.3 Photo of ESD Measurement

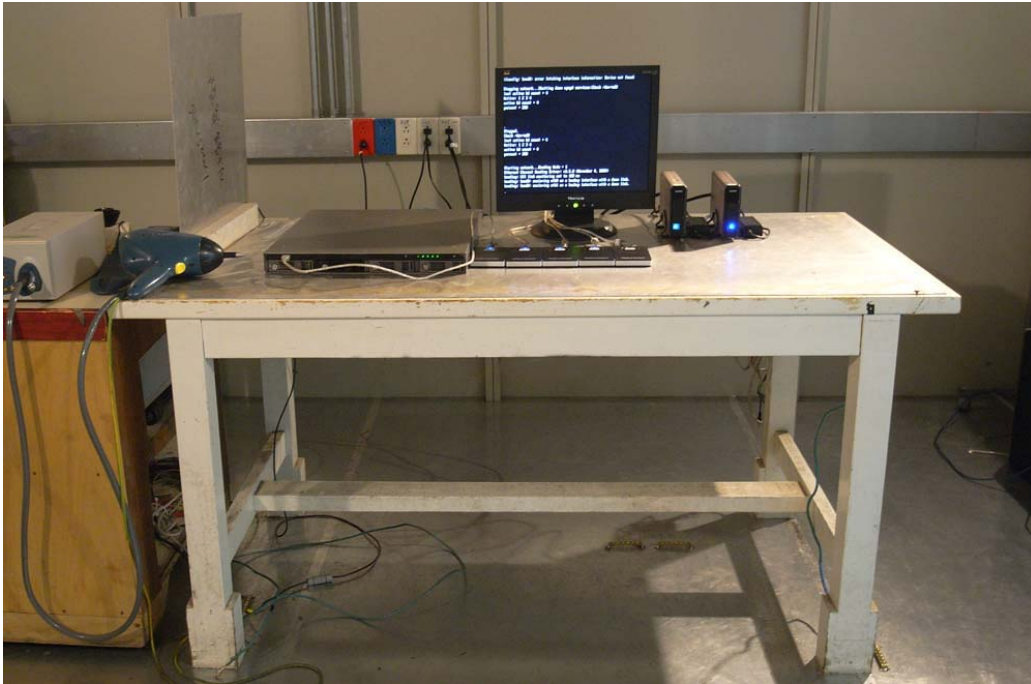

17.8.4 Photo of RF Field Strength Susceptibility Measurement

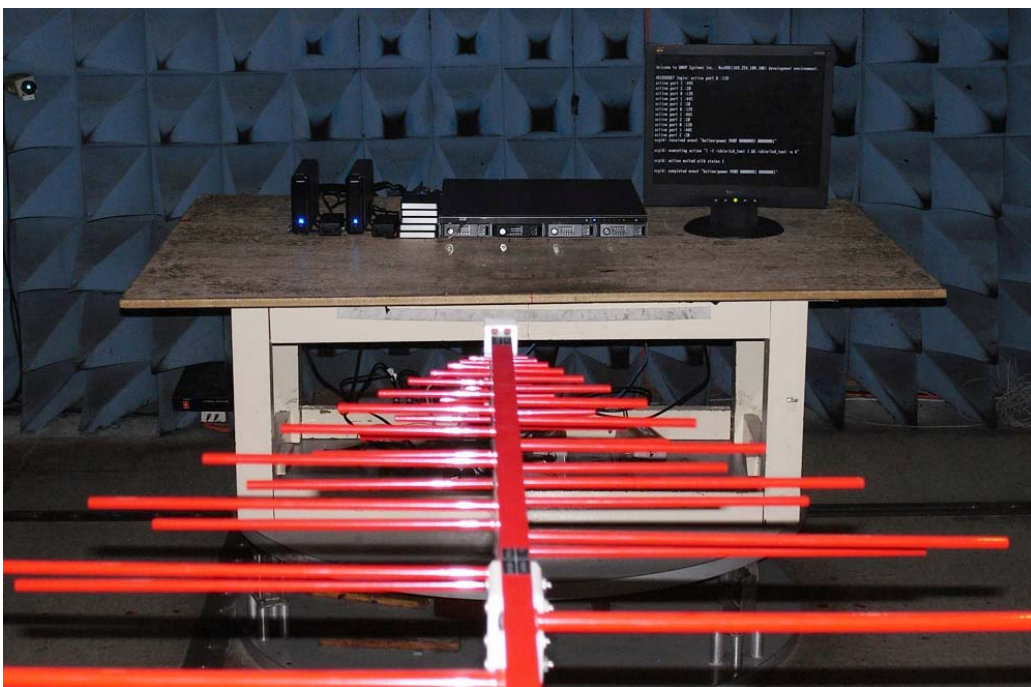

17.8.5 Photo of Electrical Fast Transient/Burst Measurement

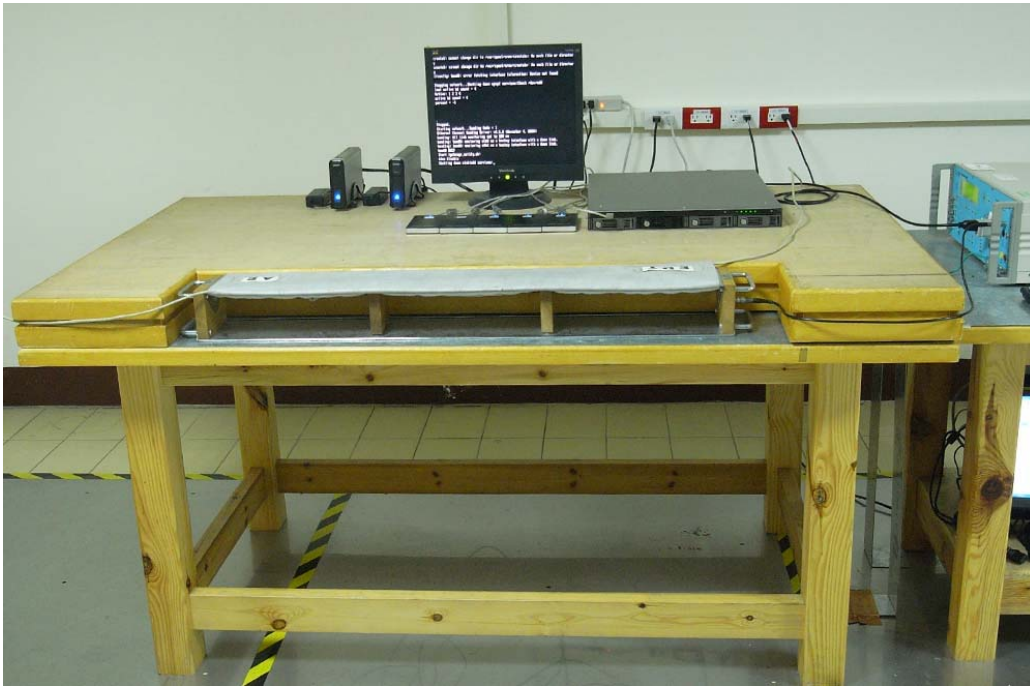

17.8.6 Photo of Surge Measurement



17.8.7 Photo of Conductive Measurement



17.8.8 Photo of Magnetic field Measurement

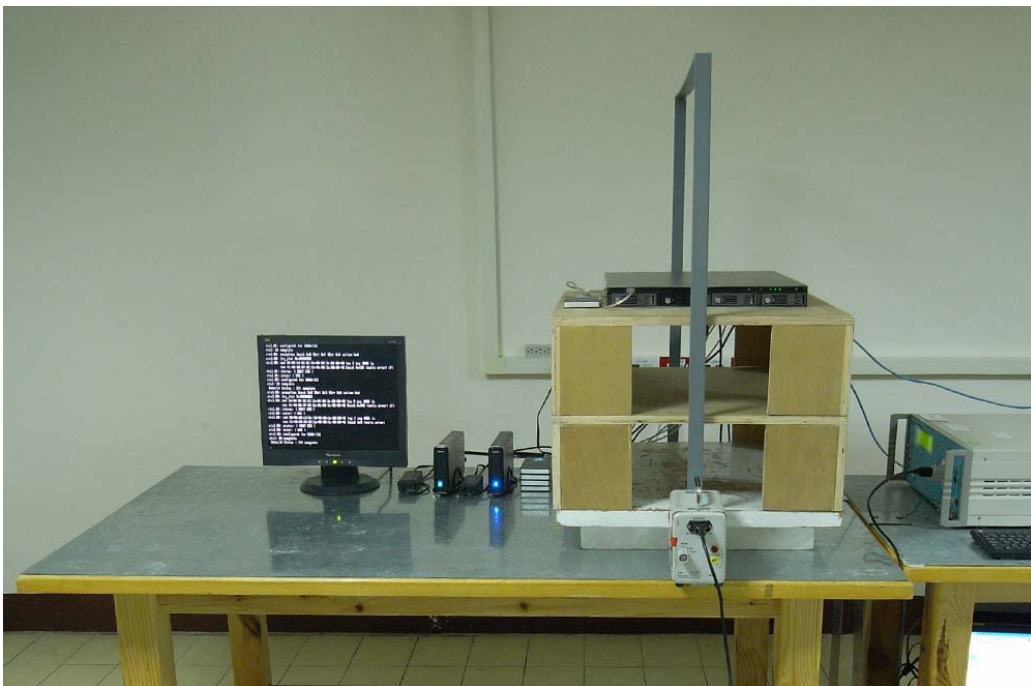

17.8.9 Photo of Voltage Dips Measurement

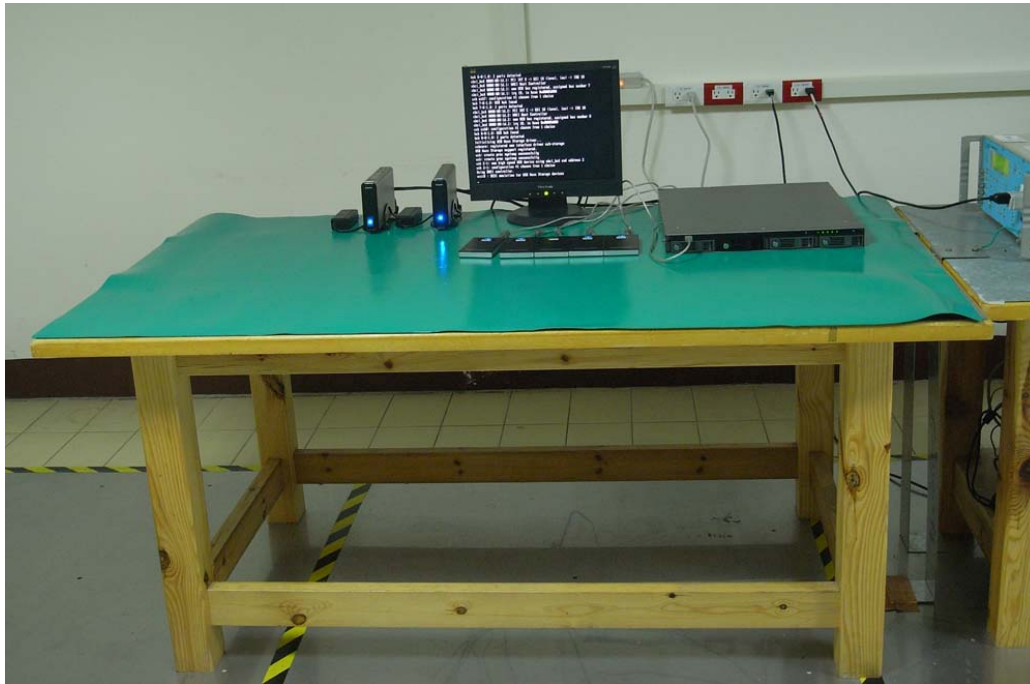

17.8.10 Photo of Harmonics and Voltage Fluctuations



17.9 Photographs of EUT

Please refer to the File of **ISL-10HE026P**

18. Attachment:

Model Number(s):

**TS-459U;TS-459U II;TS-459U II-G;TS-459U M;TS-459U Pro;TS-459U Pro II;
TS-459U Pro II-G;TS-459U Pro-G; TS-459UPro-M;TS-459U-G;DPS2140;
VS-4020U-RP Pro;VS-4004U-RP Pro;VS-4020U-SP Pro;VS-4016U-SP Pro;
VS-4012U-SP Pro;VS-4008U-SP Pro;VS-4004U-SP Pro;
NVR-4020UG-RP ;NVR-4016UG-RP;NVR-4012UG-RP ;NVR-4008UG-RP;
NVR-4004UG-RP;NVR-4020UG-SP;NVR-4016UG-SP;NVR-4012UG-SP;
NVR-4008UG-SP;NVR-4004UG-SP;NVR-4020U-RP Pro;NVR-4016U-RP Pro;
NVR-4012U-RP Pro;NVR-4008U-RP Pro;NVR-4004U-RP Pro;NVR-4020U-SP
Pro; NVR-4016U-SP Pro;NVR-4012U-SP Pro;NVR-4008U-SP
Pro;NVR-4004U-SP Pro**