

CE EMC TEST REPORT

REPORT NO.: CE980615L04B

MODEL NO.: TS-210 (refer to item 3.1 for more details)

RECEIVED: Jul. 02, 2009

TESTED: Aug. 06 ~ Aug. 14, 2009

ISSUED: Dec. 23, 2010

APPLICANT: QNAP Systems, Inc.

ADDRESS: 21 F, No. 77, Sec. 1, Xintai 5th Rd., Xizhi City, Taipei
County, 221, Taiwan

ISSUED BY: Bureau Veritas Consumer Products Services (H.K.)
Ltd., Taoyuan Branch

LAB ADDRESS: No. 19, Hwa Ya 2nd Rd., Wen Hwa Tsuen, Kwei
Shan Hsiang, Taoyuan Hsien 333, Taiwan, R.O.C.

This test report consists of 96 pages in total. It may be duplicated completely for legal use with the approval of the applicant. It should not be reproduced except in full, without the written approval of our laboratory. The client should not use it to claim product certification, approval or endorsement by TAF, NVLAP, NIST or any government agency. The test results in the report only apply to the tested sample. The test results in this report are traceable to the national or international standards.



Table of Contents

RELEASE CONTROL RECORD	6
1 CERTIFICATION	7
2 SUMMARY OF TEST RESULTS.....	8
2.1 MEASUREMENT UNCERTAINTY	9
3 GENERAL INFORMATION	10
3.1 GENERAL DESCRIPTION OF EUT	10
3.2 DESCRIPTION OF TEST MODES	12
3.3 GENERAL DESCRIPTION OF THE APPLIED STANDARD.....	13
3.4 DESCRIPTION OF SUPPORT UNITS.....	14
3.5 CONFIGURATION OF SYSTEM UNDER TEST	16
4 EMISSION TEST	18
4.1 CONDUCTED EMISSION MEASUREMENT	18
4.1.1 LIMITS OF CONDUCTED EMISSION MEASUREMENT	18
4.1.2 TEST INSTRUMENTS.....	18
4.1.3 TEST PROCEDURE.....	19
4.1.4 DEVIATION FROM TEST STANDARD	19
4.1.5 TEST SETUP	20
4.1.6 EUT OPERATING CONDITIONS.....	20
4.1.7 TEST RESULTS	21
4.2 CONDUCTED EMISSION MEASUREMENT AT TELECOMMUNICATION PORTS	23
4.2.1 LIMIT OF CONDUCTED COMMON MODE DISTURBANCE AT TELECOMMUNICATION PORTS.....	23
4.2.2 TEST INSTRUMENTS.....	24
4.2.3 TEST PROCEDURE.....	25
4.2.4 DEVIATION FROM TEST STANDARD	25
4.2.5 TEST SETUP	26
4.2.6 EUT OPERATING CONDITIONS.....	27
4.2.7 TEST RESULTS	28
4.3 RADIATED EMISSION MEASUREMENT	31
4.3.1 LIMITS OF RADIATED EMISSION MEASUREMENT	31
4.3.2 TEST INSTRUMENTS.....	32
4.3.3 TEST PROCEDURE.....	34
4.3.4 DEVIATION FROM TEST STANDARD	34
4.3.5 TEST SETUP	35

4.3.6	EUT OPERATING CONDITIONS.....	35
4.3.7	TEST RESULTS	36
4.4	HARMONICS CURRENT MEASUREMENT	40
4.4.1	LIMITS OF HARMONICS CURRENT MEASUREMENT	40
4.4.2	TEST INSTRUMENTS.....	41
4.4.3	TEST PROCEDURE.....	41
4.4.4	DEVIATION FROM TEST STANDARD	42
4.4.5	TEST SETUP	42
4.4.6	EUT OPERATING CONDITIONS.....	42
4.4.7	TEST RESULTS	43
4.5	VOLTAGE FLUCTUATION AND FLICKS MEASUREMENT	44
4.5.1	LIMITS OF VOLTAGE FLUCTUATION AND FLICKS MEASUREMENT	44
4.5.2	TEST INSTRUMENTS.....	44
4.5.3	TEST PROCEDURE.....	44
4.5.4	DEVIATION FROM TEST STANDARD	45
4.5.5	TEST SETUP	45
4.5.6	EUT OPERATING CONDITIONS.....	45
4.5.7	TEST RESULTS	46
5	IMMUNITY TEST.....	47
5.1	GENERAL DESCRIPTION	47
5.2	GENERAL PERFORMANCE CRITERIA DESCRIPTION.....	48
5.3	PARTICULAR PERFORMANCE CRITERIA DESCRIPTION FOR READ, WRITE AND STORAGE OF DATA FUNCTION.....	49
5.4	EUT OPERATING CONDITION.....	49
5.5	ELECTROSTATIC DISCHARGE IMMUNITY TEST (ESD).....	50
5.5.1	TEST SPECIFICATION	50
5.5.2	TEST INSTRUMENTS.....	50
5.5.3	TEST PROCEDURE.....	51
5.5.4	DEVIATION FROM TEST STANDARD	52
5.5.5	TEST SETUP	52
5.5.6	TEST RESULTS	53
5.6	RADIATED, RADIO-FREQUENCY, ELECTROMAGNETIC FIELD IMMUNITY TEST (RS).....	56
5.6.1	TEST SPECIFICATION	56
5.6.2	TEST INSTRUMENTS.....	56
5.6.3	TEST PROCEDURE.....	57

5.6.4	DEVIATION FROM TEST STANDARD	57
5.6.5	TEST SETUP	58
5.6.6	TEST RESULTS	59
5.7	ELECTRICAL FAST TRANSIENT/BURST IMMUNITY TEST (EFT)	60
5.7.1	TEST SPECIFICATION	60
5.7.2	TEST INSTRUMENTS.....	60
5.7.3	TEST PROCEDURE.....	60
5.7.4	DEVIATION FROM TEST STANDARD	61
5.7.5	TEST SETUP	61
5.7.6	TEST RESULTS	62
5.8	SURGE IMMUNITY TEST	63
5.8.1	TEST SPECIFICATION	63
5.8.2	TEST INSTRUMENTS.....	63
5.8.3	TEST PROCEDURE.....	64
5.8.4	DEVIATION FROM TEST STANDARD	64
5.8.5	TEST SETUP	65
5.8.6	TEST RESULTS	66
5.9	IMMUNITY TO CONDUCTED DISTURBANCES INDUCED BY RF FIELDS (CS) ..	67
5.9.1	TEST SPECIFICATION	67
5.9.2	TEST INSTRUMENTS.....	67
5.9.3	TEST PROCEDURE.....	68
5.9.4	DEVIATION FROM TEST STANDARD	68
5.9.5	TEST SETUP	69
5.9.6	TEST RESULTS	70
5.10	POWER FREQUENCY MAGNETIC FIELD IMMUNITY TEST	71
5.10.1	TEST SPECIFICATION	71
5.10.2	TEST INSTRUMENTS.....	71
5.10.3	TEST PROCEDURE.....	71
5.10.4	DEVIATION FROM TEST STANDARD	71
5.10.5	TEST SETUP	72
5.10.6	TEST RESULTS	73
5.11	VOLTAGE DIP/SHORT INTERRUPTIONS/VOLTAGE VARIATIONS (DIP) IMMUNITY TEST.....	74
5.11.1	TEST SPECIFICATION	74
5.11.2	TEST INSTRUMENTS.....	74
5.11.3	TEST PROCEDURE.....	74



5.11.4	DEVIATION FROM TEST STANDARD	74
5.11.5	TEST SETUP	75
5.11.6	TEST RESULTS	76
6	PHOTOGRAPHS OF THE TEST CONFIGURATION.....	77
7	PHOTOGRAPHS OF THE EQUIPMENT UNDER TEST.....	86
8	INFORMATION ON THE TESTING LABORATORIES	96



A D T

RELEASE CONTROL RECORD

ISSUE NO.	REASON FOR CHANGE	DATE ISSUED
Original release	N/A	Dec. 23, 2010

1 CERTIFICATION

PRODUCT: Network Attached Storage
BRAND: QNAP
MODEL NO.: TS-210 (refer to item 3.1 for more details)
APPLICANT: QNAP Systems, Inc.
TESTED: Aug. 06 ~ Aug. 14, 2009
TEST SAMPLE: ENGINEERING SAMPLE
STANDARD: EN 55022: 2006+A1: 2007, Class B
EN 61000-3-2: 2006+A1: 2009+A2: 2009, Class A
EN 61000-3-3: 2008
EN 55024: 1998+A1: 2001+A2: 2003
IEC 61000-4-2: 2008 ED. 2.0
IEC 61000-4-3: 2006+A1: 2007 ED. 3.0
IEC 61000-4-4: 2004+A1: 2010 ED. 2.0
IEC 61000-4-5: 2005 ED. 2.0
IEC 61000-4-6: 2008 ED. 3.0
IEC 61000-4-8: 2009 ED. 2.0
IEC 61000-4-11: 2004 ED. 2.0

The above equipment (Model: TS-210) has been tested by **Bureau Veritas Consumer Products Services (H.K.) Ltd., Taoyuan Branch**, and found compliance with the requirement of the above standards. The test record, data evaluation & Equipment Under Test (EUT) configurations represented herein are true and accurate accounts of the measurements of the sample's EMC characteristics under the conditions specified in this report.

PREPARED BY :  , DATE : Dec. 23, 2010
Suntee Liu / Specialist

APPROVED BY :  , DATE : Dec. 23, 2010
David Liu / Senior Engineer

2 SUMMARY OF TEST RESULTS

After estimating all the combination of every test mode, the result shown as below is the worst case.

The EUT has been tested according to the following specifications.

EMISSION			
Standard	Test Type	Result	Remarks
EN 55022: 2006+A1: 2007, Class B	Conducted emission test	PASS	Meet the requirement of limit. Minimum passing margin is -10.00dB at 17.264MHz.
	Conducted emission test at telecom port	PASS	Meet the requirement of limit. Minimum passing margin is -20.20dB at 17.606MHz.
	Radiated emission test (30MHz~6GHz)	PASS	Meet the requirement of limit. Minimum passing margin is -3.21dB at 2800.01MHz.
EN 61000-3-2: 2006+A1: 2009+A2: 2009, Class A	Harmonic current emission test	PASS	The power consumption of EUT is less than 75W and no limits apply
EN 61000-3-3: 2008	Voltage fluctuations & flicker tests	PASS	Meets the requirements

IMMUNITY (EN 55024: 1998+A1: 2001+A2: 2003)			
Standard	Test Type	Result	Remarks
IEC 61000-4-2: 2008 ED. 2.0	Electrostatic discharge immunity test	PASS	Meets the requirements of Performance Criterion B
IEC 61000-4-3: 2006+A1: 2007 ED. 3.0	Radiated, radio-frequency, electromagnetic field immunity test	PASS	Meets the requirements of Performance Criterion A
IEC 61000-4-4: 2004+A1: 2010 ED. 2.0	Electrical fast transient / burst immunity test	PASS	Meets the requirements of Performance Criterion A
IEC 61000-4-5: 2005 ED. 2.0	Surge immunity test	PASS	Meets the requirements of Performance Criterion A
IEC 61000-4-6: 2008 ED. 3.0	Immunity to conducted disturbances, induced by radio-frequency fields	PASS	Meets the requirements of Performance Criterion A
IEC 61000-4-8: 2009 ED. 2.0	Power frequency magnetic field immunity test.	PASS	Meets the requirements of Performance Criterion A
IEC 61000-4-11: 2004 ED. 2.0	Voltage dips, short interruptions and voltage variations immunity tests	PASS	Meets the requirements of Voltage Dips: 1. >95% reduction - Performance Criterion A 2. 30% reduction - Performance Criterion A Voltage Interruptions: 1. >95% reduction - Performance Criterion C

2.1 MEASUREMENT UNCERTAINTY

Where relevant, the following measurement uncertainty levels have been estimated for tests performed on the EUT as specified in CISPR 16-4-2:

Measurement	Frequency	Uncertainty
Conducted emission	150kHz ~ 30MHz	2.44dB
Conducted emission at telecom port	150kHz ~ 30MHz	2.69dB
Radiated emission	30MHz ~ 200MHz	3.69dB
	200MHz ~ 1000MHz	3.84dB
	1GHz ~ 6GHz	2.26dB

This uncertainty represents an expanded uncertainty expressed at approximately the 95% confidence level using a coverage factor of k=2.

3 GENERAL INFORMATION

3.1 GENERAL DESCRIPTION OF EUT

PRODUCT	Network Attached Storage
MODEL NO.	TS-210 (refer to Note for more details)
POWER SUPPLY	12Vdc from adapter
DATA CABLE	NA
ACCESSORY DEVICE	Adapter

NOTE:

1. This is a duplicate report of CE980615L04A. The only difference compared with original report is adding model designation.
2. The EUT uses following models. (New models are marked in boldface.)

MODEL	DESCRIPTION
Q700	Original models
TS-209 V	
TS-210 Pro	
TS-210	
TS-210 Pro II	
TS-210 II	
TS-210 Pro-G	
TS-210-G	
TS-210 Pro II-G	
TS-210 II-G	
TS-210 Pro-M	
TS-210 M	
TS-219 V	
VS-2204	
VS-2208	
VS-2212	
VS-2216	
NVR-2204	
NVR-2208	
NVR-2212	
NVR-2216	
NV-2204	
NV-2208	
NV-2212	
NV-2216	

MODEL	DESCRIPTION
TS-212	New models have only half memory from original models.
TS-212P II	
TS-212P II+	
TS-212j	
TS-212j+	
TS-212J II	
TS-212j II+	
TS-212 Pro	
TS-212 Pro+	
TS-212G	
TS-212G+	
TS-212G Pro	
TS-212G Pro+	
TS-212G Pro II	

3. The EUT uses following adapter.

BRAND	FSP GROUP INC.
MODEL	FSP060-DBAB1
INPUT POWER	100-240Vac, 1.5A, 50-60Hz
OUTPUT POWER	12Vdc, 5A
POWER LINE	AC 1.8 m shielded cable without core DC 1.5 m non-shielded cable with 1 core

4. The EUT's highest operating frequency is 1.2 GHz.
5. The above EUT information was declared by manufacturer and for more detailed features description, please refer to the manufacturer's specifications or User's Manual.

3.2 DESCRIPTION OF TEST MODES

The EUT is designed with AC power supply of 100-240Vac, 50/60Hz. For EMI evaluation, 230Vac/50Hz (for EN 55022) & 120Vac/60Hz (for FCC Part 15) had been covered during the pre-test. The worst radiated emission data was found at **230Vac/50Hz** and recorded in the applied test report.

2 samples were pre-tested, and sample 2 was the worst case for final test.

The EUT was pre-tested under following modes, and test mode 1 was the worst case for final test.

Test Mode	Test Condition
1	LAN 1 Gbps, 230 Vac / 50 Hz
2	LAN 100 Mbps, 230 Vac / 50 Hz
3	LAN 10 Mbps, 230 Vac / 50 Hz
4	LAN 1 Gbps, EUT horizontal, 230 Vac / 50 Hz
5	LAN 1 Gbps, 120 Vac / 60 Hz

3.3 GENERAL DESCRIPTION OF THE APPLIED STANDARD

The EUT is a kind of ITE equipment, and according to the specifications of the manufacturers, must comply with the requirements of the following standards:

EN 55022: 2006+A1: 2007, Class B

EN 61000-3-2: 2006+A1: 2009+A2: 2009, Class A

EN 61000-3-3: 2008

EN 55024: 1998+A1: 2001+A2: 2003

IEC 61000-4-2: 2008 ED. 2.0

IEC 61000-4-3: 2006+A1: 2007 ED. 3.0

IEC 61000-4-4: 2004+A1: 2010 ED. 2.0

IEC 61000-4-5: 2005 ED. 2.0

IEC 61000-4-6: 2008 ED. 3.0

IEC 61000-4-8: 2009 ED. 2.0

IEC 61000-4-11: 2004 ED. 2.0

Note: The above IEC basic standards are applied with latest version if customer has no special requirement.

All tests have been performed and recorded as per the above standards.

3.4 DESCRIPTION OF SUPPORT UNITS

The EUT has been tested as an independent unit together with other necessary accessories or support units. The following support units or accessories were used to form a representative test configuration during the tests.

For emission test

NO.	PRODUCT	BRAND	MODEL NO.	SERIAL NO.	FCC ID
1	IPOD MINI	apple	A1051	YM5270HGS41	NA
2	IPOD MINI	apple	A1051	YM5270HGS41	NA
3	EXTERNAL HARD DISK	Terasys	F12-UF	A0100222-4990026	FCC DoC Approved
4	NOTEBOOK	DELL	PP18L	D1T5W1S 28407620224	QDS-BRCM1019

NO.	SIGNAL CABLE DESCRIPTION OF THE ABOVE SUPPORT UNITS
1	1.5 m shielded cable, terminated with USB connector, w/o core
2	1.5 m shielded cable, terminated with USB connector, w/o core
3	1.5 m shielded cable, terminated with USB connector, w/o core
4	10 m shielded RJ45 cable

NOTE:

1. All power cords of the above support units are non-shielded (1.8 m).
2. Item 4 acted as a communication partner to transfer data.

For harmonic, flicker & immunity tests

NO.	PRODUCT	BRAND	MODEL NO.	SERIAL NO.	FCC ID
1	EXTERNAL HARD DISK	Sarotech	FHD-354	NA	PBCFHD-354
2	EXTERNAL HARD DISK	Sarotech	FHD-354	NA	PBCFHD-354
3	EXTERNAL HARD DISK	Sarotech	FHD-354	NA	PBCFHD-354
4	PC	DELL	GX620	9C34M1S	NA
5	24" LCD MONITOR	DELL	2407WFPb	CN-0YY528-46633-76I-1E7S	FCC DoC Approved
6	KEYBOARD	DELL	SK8115	CN-0J4635-71616-53A-0CL5	FCC DoC Approved
7	MOUSE	Microsoft	ITE78CJ	NA	FCC DoC Approved

NO.	SIGNAL CABLE DESCRIPTION OF THE ABOVE SUPPORT UNITS
1	1.5 m shielded cable, terminated with USB connector, w/o core
2	1.5 m shielded cable, terminated with USB connector, w/o core
3	1.5 m shielded cable, terminated with USB connector, w/o core
4	10 m shielded RJ45 cable
5	1.8 m braid shielded wire, D-SUB connector, with two cores
6	1.8 m shielded cable, terminated with USB connector, w/o core
7	1.8 m foil shielded wire, USB Connector, with core

NOTE:

1. All power cords of the above support units are non-shielded (1.8 m).
2. Items 4-7 acted as communication partners to transfer data.

3.5 CONFIGURATION OF SYSTEM UNDER TEST

For emission test

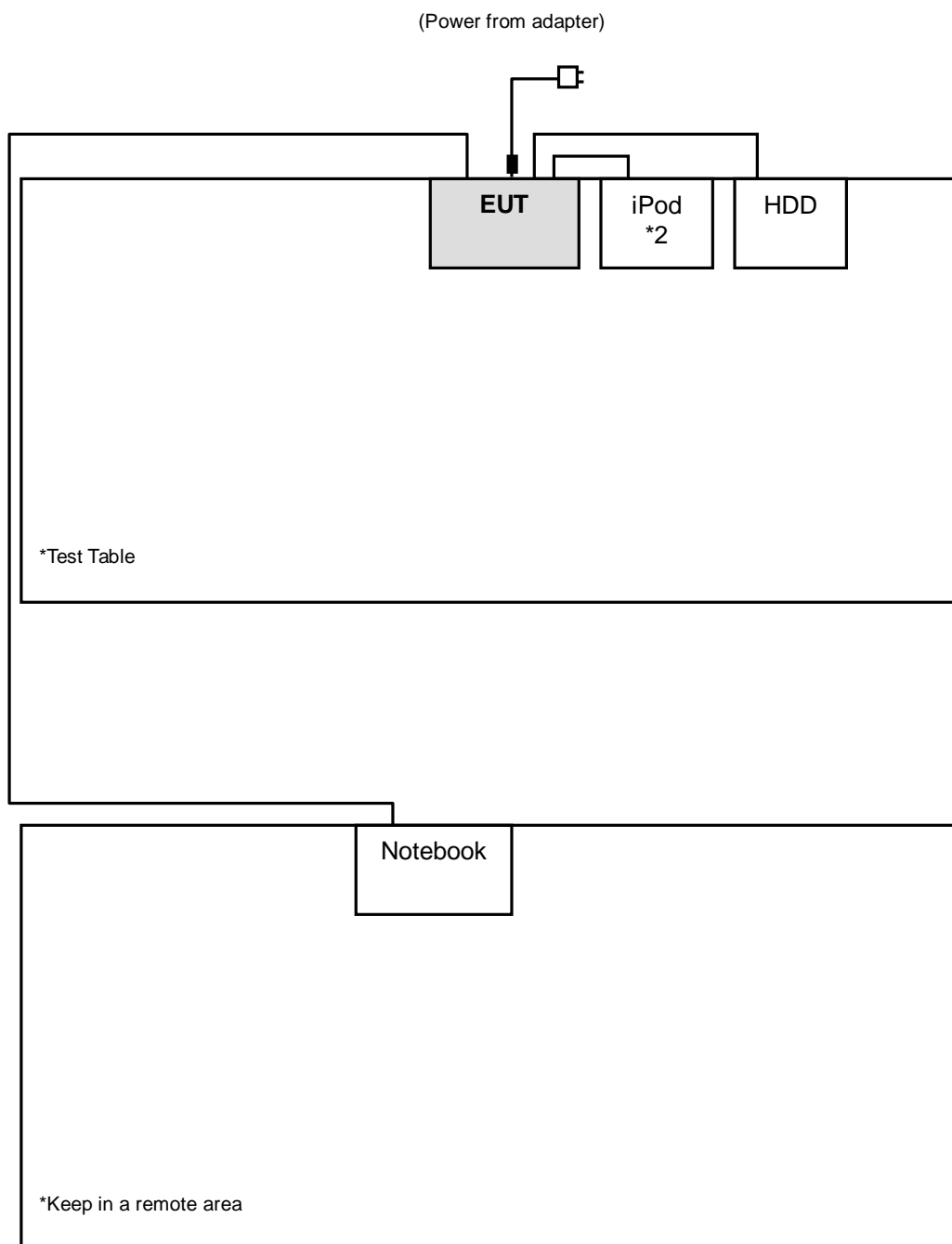

For harmonic, flicker & immunity tests

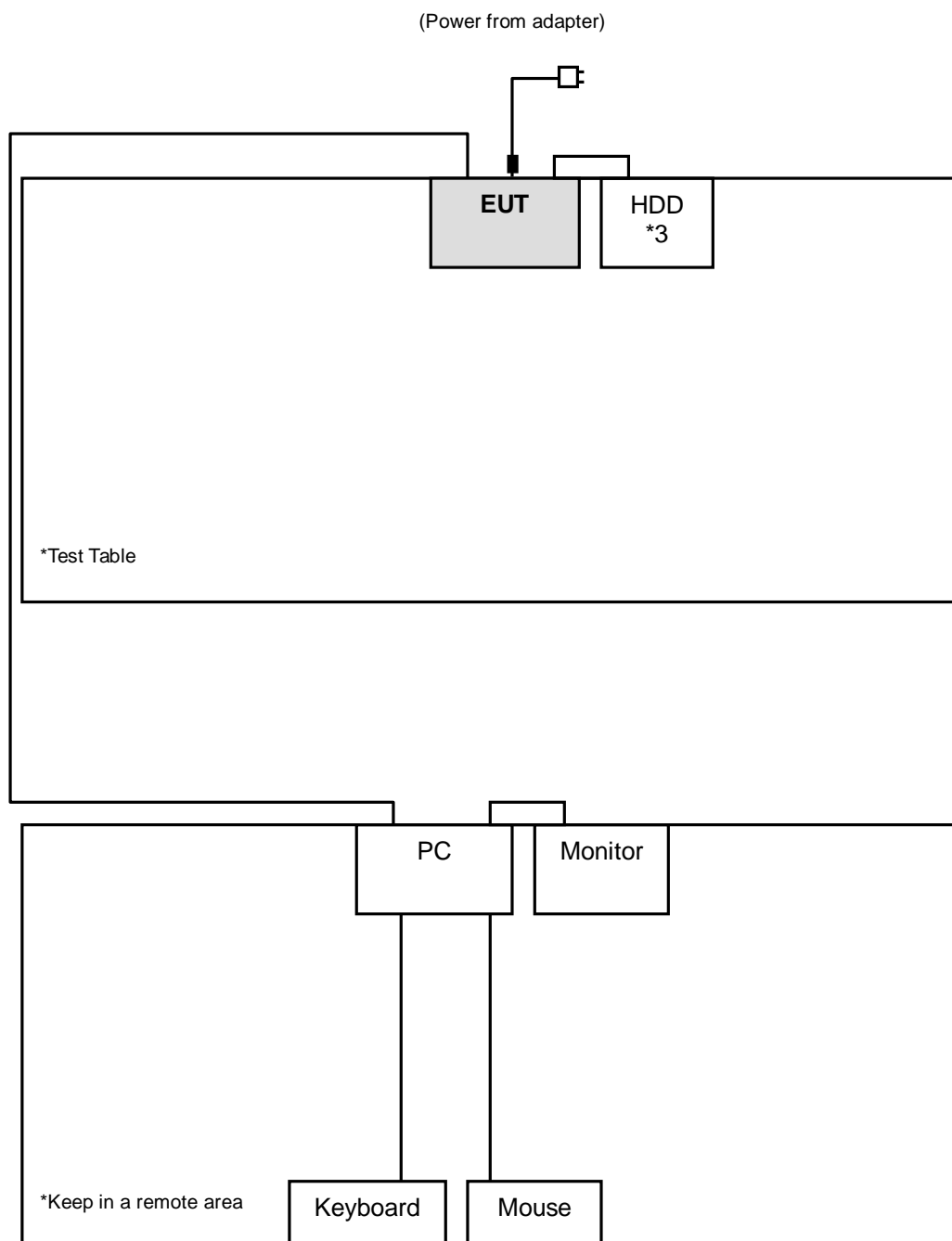

4 EMISSION TEST

4.1 CONDUCTED EMISSION MEASUREMENT

4.1.1 LIMITS OF CONDUCTED EMISSION MEASUREMENT

TEST STANDARD: EN 55022

Frequency (MHz)	Class A (dBuV)		Class B (dBuV)	
	Quasi-peak	Average	Quasi-peak	Average
0.15-0.5	79	66	66-56	56-46
0.5-5	73	60	56	46
5-30	73	60	60	50

- NOTE:**
1. The lower limit shall apply at the transition frequencies.
 2. The limit decreases in line with the logarithm of the frequency in the range of 0.15 to 0.50 MHz.
 3. All emanations from a class A/B digital device or system, including any network of conductors and apparatus connected thereto, shall not exceed the level of field strengths specified above.

4.1.2 TEST INSTRUMENTS

DESCRIPTION & MANUFACTURER	MODEL NO.	SERIAL NO.	DATE OF CALIBRATION	DUE DATE OF CALIBRATION
Test Receiver ROHDE & SCHWARZ	ESCS30	100291	Nov. 19, 2008	Nov. 18, 2009
RF signal cable Woken	5D-FB	Cable-HYC01-01	Dec. 31, 2008	Dec. 30, 2009
LISN SCHWARZBECK	NNBL 8226-2	8226-142	Jun. 03, 2009	Jun. 02, 2010
LISN ROHDE & SCHWARZ	ESH2-Z5	100104	Dec. 04, 2008	Dec. 03, 2009
Software ADT	ADT_Cond_ V7.3.7	NA	NA	NA

- NOTE:**
1. The calibration interval of the above test instruments is 12 months and the calibrations are traceable to NML/ROC and NIST/USA.
 2. The test was performed in HwaYa Shielded Room 1.
 3. The VCCI Site Registration No. is C-2040.

4.1.3 TEST PROCEDURE

- a. The EUT was placed 0.4 meters from the conducting wall of the shielded room with EUT being connected to the power mains through a line impedance stabilization network (LISN). Other support units were connected to the power mains through another LISN. The two LISNs provide 50 Ohm/ 50uH of coupling impedance for the measuring instrument.
- b. Both lines of the power mains connected to the EUT were checked for maximum conducted interference.
- c. The frequency range from 150 kHz to 30 MHz was searched. Emission levels under (Limit - 20dB) was not reported.

4.1.4 DEVIATION FROM TEST STANDARD

No deviation.

4.1.5 TEST SETUP

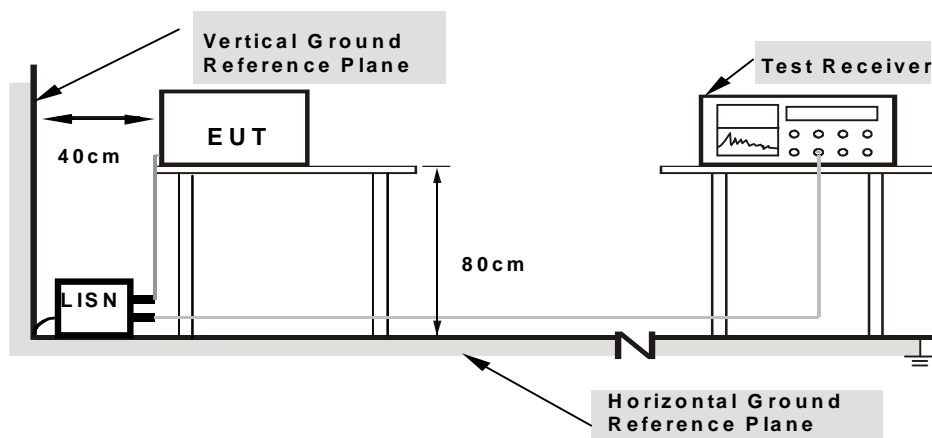

- Note:**
1. Support units were connected to second LISN.
 2. Both of LISNs (AMN) are 80 cm from EUT and at least 80 cm from other units and other metal planes

For the actual test configuration, please refer to the related item – Photographs of the Test Configuration.

4.1.6 EUT OPERATING CONDITIONS

- a. The notebook ran a test program to enable all functions.
- b. The notebook communicated data with the EUT, iPods and external HDD.

4.1.7 TEST RESULTS

INPUT POWER	230 Vac, 50 Hz	6dB BANDWIDTH	9 kHz
ENVIRONMENTAL CONDITIONS	22 deg. C, 66% RH, 980 hPa	PHASE	Line 1
TESTED BY	Kevin Chen		

No	Freq. [MHz]	Corr. Factor (dB)	Reading Value [dB (uV)]		Emission Level [dB (uV)]		Limit [dB (uV)]		Margin (dB)	
			Q.P.	AV.	Q.P.	AV.	Q.P.	AV.	Q.P.	AV.
1	0.197	0.13	39.59	30.04	39.72	30.17	63.74	53.74	-24.02	-23.57
2	0.263	0.13	32.75	26.06	32.88	26.19	61.33	51.33	-28.44	-25.13
3	0.988	0.15	28.02	27.83	28.17	27.98	56.00	46.00	-27.83	-18.02
4	1.384	0.17	28.96	28.35	29.13	28.52	56.00	46.00	-26.87	-17.48
5	2.832	0.25	28.54	27.06	28.79	27.31	56.00	46.00	-27.21	-18.69
6	9.945	0.75	35.78	33.29	36.53	34.04	60.00	50.00	-23.47	-15.96
7	17.130	1.19	40.84	36.09	42.03	37.28	60.00	50.00	-17.97	-12.72

- REMARKS:**
1. Q.P. and AV. are abbreviations of quasi-peak and average individually.
 2. "-": The Quasi-peak reading value also meets average limit and measurement with the average detector is unnecessary.
 3. The emission levels of other frequencies were very low against the limit.
 4. Margin value = Emission level - Limit value
 5. Correction factor = Insertion loss + Cable loss
 6. Emission Level = Correction Factor + Reading Value.

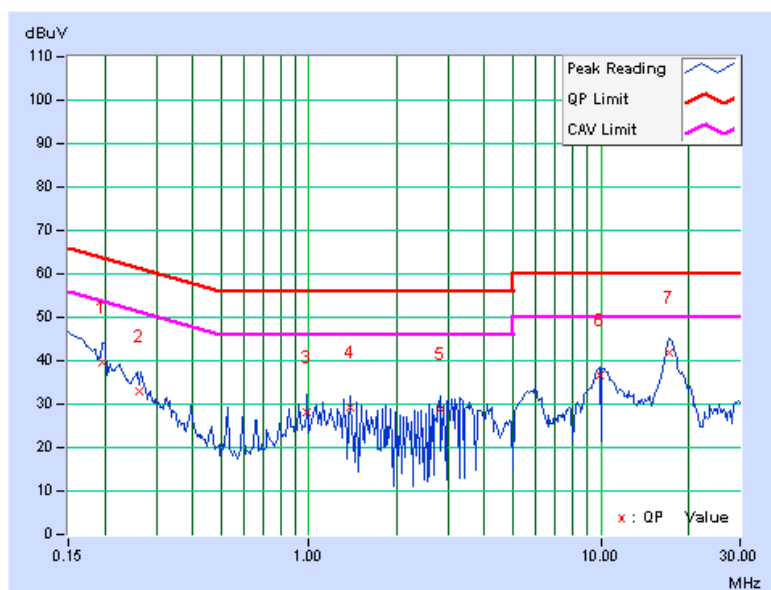

INPUT POWER	230 Vac, 50 Hz	6dB BANDWIDTH	9 kHz
ENVIRONMENTAL CONDITIONS	22 deg. C, 66% RH, 980 hPa	PHASE	Line 2
TESTED BY	Kevin Chen		

No	Freq. [MHz]	Corr. Factor (dB)	Reading Value [dB (uV)]		Emission Level [dB (uV)]		Limit [dB (uV)]		Margin (dB)	
			Q.P.	AV.	Q.P.	AV.	Q.P.	AV.	Q.P.	AV.
1	0.197	0.09	39.12	31.27	39.21	31.36	63.74	53.74	-24.53	-22.38
2	0.330	0.10	30.12	28.32	30.22	28.42	59.46	49.46	-29.24	-21.04
3	0.923	0.11	31.75	31.05	31.86	31.16	56.00	46.00	-24.14	-14.84
4	1.582	0.13	33.25	32.97	33.38	33.10	56.00	46.00	-22.62	-12.90
5	2.637	0.18	32.01	30.80	32.19	30.98	56.00	46.00	-23.81	-15.02
6	17.264	0.83	45.09	39.17	45.92	40.00	60.00	50.00	-14.08	-10.00

- REMARKS:**
1. Q.P. and AV. are abbreviations of quasi-peak and average individually.
 2. "-": The Quasi-peak reading value also meets average limit and measurement with the average detector is unnecessary.
 3. The emission levels of other frequencies were very low against the limit.
 4. Margin value = Emission level - Limit value
 5. Correction factor = Insertion loss + Cable loss
 6. Emission Level = Correction Factor + Reading Value.

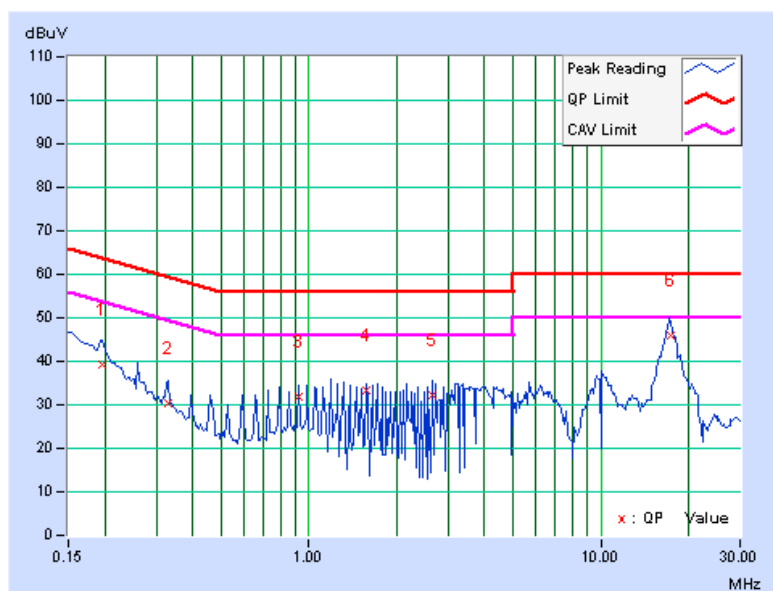

4.2 CONDUCTED EMISSION MEASUREMENT AT TELECOMMUNICATION PORTS

4.2.1 LIMIT OF CONDUCTED COMMON MODE DISTURBANCE AT TELECOMMUNICATION PORTS

TEST STANDARD: EN 55022

For Class A Equipment

Frequency (MHz)	Voltage Limit (dBuV)		Current Limit (dBuA)	
	Quasi-peak	Average	Quasi-peak	Average
0.15-0.5	97-87	84-74	53-43	40-30
0.5-30	87	74	43	30

NOTE: The limits decrease linearly with the logarithm of the frequency in the range 0.15 MHz to 0.5 MHz.

For Class B Equipment

Frequency (MHz)	Voltage Limit (dBuV)		Current Limit (dBuA)	
	Quasi-peak	Average	Quasi-peak	Average
0.15-0.5	84-74	74-64	40-30	30-20
0.5-30	74	64	30	20

NOTE: The limits decrease linearly with the logarithm of the frequency in the range 0.15 MHz to 0.5 MHz.

4.2.2 TEST INSTRUMENTS

DESCRIPTION & MANUFACTURER	MODEL NO.	SERIAL NO.	DATE OF CALIBRATION	DUE DATE OF CALIBRATION
Test Receiver ROHDE & SCHWARZ	ESCS30	100291	Nov. 19, 2008	Nov. 18, 2009
RF signal cable Woken	5D-FB	Cable-HYC01-01	Dec. 31, 2008	Dec. 30, 2009
LISN SCHWARZBECK	NNBL 8226-2	8226-142	Jun. 03, 2009	Jun. 02, 2010
LISN ROHDE & SCHWARZ	ESH2-Z5	100104	Dec. 04, 2008	Dec. 03, 2009
Software ADT	ADT_Cond_V7.3.7	NA	NA	NA
ISN	FCC-TLISN-T4-02	20161	Jun. 25, 2009	Jun. 24, 2010
ISN	FCC-TLISN-T2-02	20180	Jun. 25, 2009	Jun. 24, 2010
ISN	FCC-TLISN-T8-02	20181	Jun. 25, 2009	Jun. 24, 2010
COMMON MODE ISN	F-CMISN-CAT5	06001	Jan. 12, 2009	Jan. 11, 2010
Capacitive Voltage Probe	F-CVP-1	82	Jun. 17, 2009	Jun. 16, 2010
RF Current Probe	F-33-4	45	Sep. 15, 2008	Sep. 14, 2009
Coupling And Decoupling Network	CDN RJ45-S	07	Apr. 01, 2008	Mar. 31, 2010

- NOTE:**
1. The calibration interval of the above test instruments is 12 months and the calibrations are traceable to NML/ROC and NIST/USA.
 2. The test was performed in HwaYa Shielded Room 1.
 3. The VCCI Site Registration No. is C-2040, T-308.

4.2.3 TEST PROCEDURE

For ISN:

- a. The EUT was placed 0.4 meters from the conducting wall of the shielded room and connected to the power mains through a line impedance stabilization network (LISN). Other support units were connected to the power mains through another LISN.
- b. Voltage at the measurement port of the ISN was detected, the reading was corrected by adding the voltage division factor of the ISN, and was compared to the voltage limits.
- c. The disturbance levels and the frequencies of at least six highest disturbances were recorded from each telecommunication port, which comprises the EUT.

For Current Probe:

- a. Current probe shall be placed at 0.1 m from the ISN.
- b. Current at the measurement port of the ISN was detected, the reading was corrected by adding the current division factor of the current probe, and was compared to the current limits.
- c. The disturbance levels and the frequencies of at least six highest disturbances were recorded from each telecommunication port, which comprises the EUT.
- d. Break the insulation and connect a $150\ \Omega$ resistor from the outside surface of the shield to ground and apply a clamp between $150\ \Omega$ connection and associated equipment (For STP LAN only).

For Voltage Probe:

- a. The EUT was placed 0.4 meters from the conducting wall of the shielded room and connected to the power mains through a line impedance stabilization network (LISN). Other support units were connected to the power mains through another LISN.
- b. Voltage at the measurement port of the voltage probe was detected, the reading was corrected by adding the voltage division factor of the voltage probe, and was compared to the voltage limits.
- c. The disturbance levels and the frequencies of at least six highest disturbances were recorded from each telecommunication port, which comprises the EUT.

4.2.4 DEVIATION FROM TEST STANDARD

No deviation.

4.2.5 TEST SETUP

For ISN & Current Probe (UTP LAN cable):

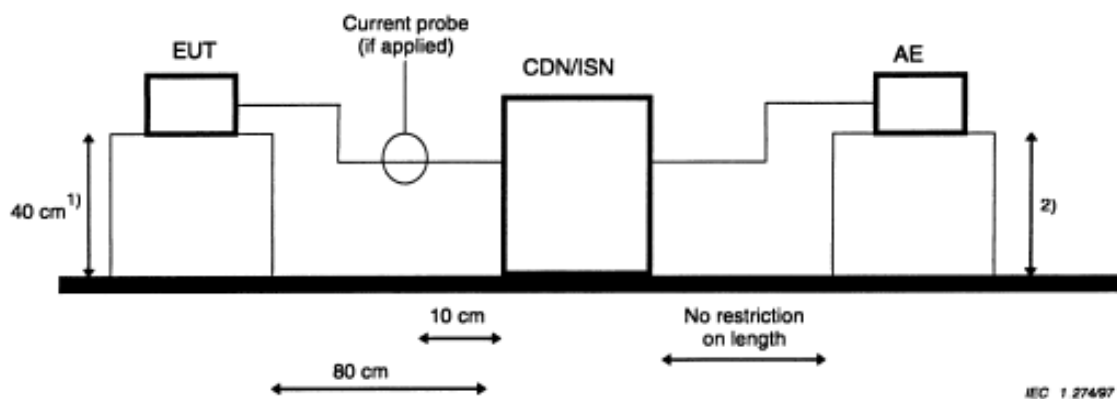

AE = Associated equipment
EUT = Equipment under test

- 1) Distance to the reference groundplane (vertical or horizontal).
- 2) Distance to the reference groundplane is not critical.

For Current Probe (STP LAN cable):

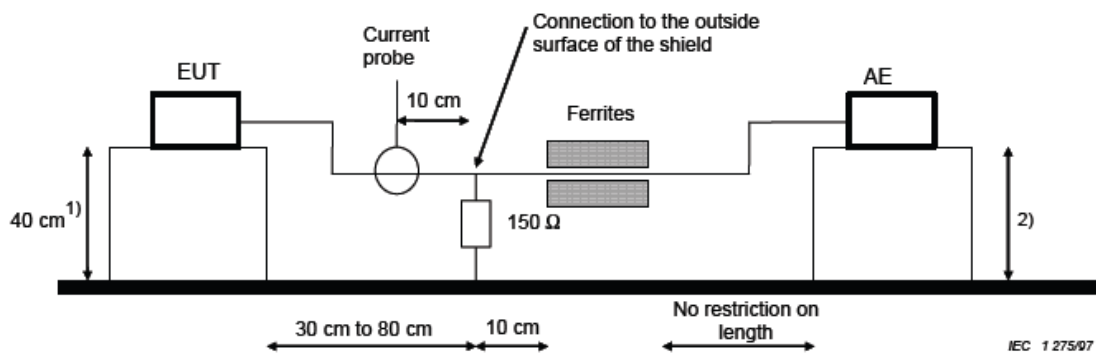

AE = Associated equipment
EUT = Equipment under test

For Voltage & Current Probe:

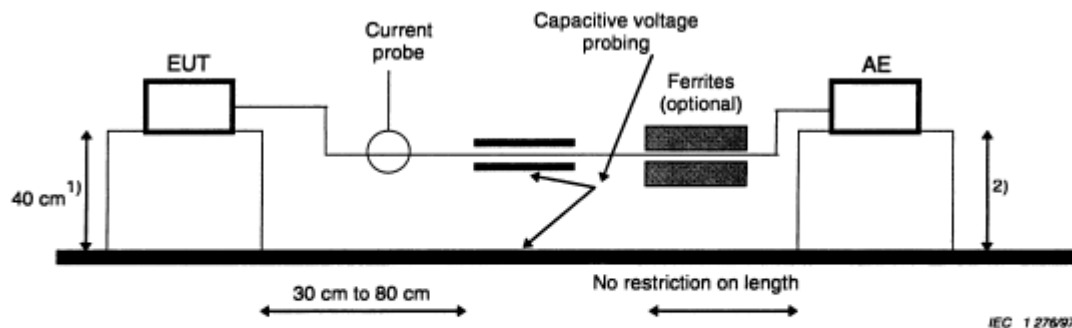

AE = Associated equipment
EUT = Equipment under test

1) Distance to the reference groundplane (vertical or horizontal).

2) Distance to the reference groundplane is not critical.

For the actual test configuration, please refer to the related item – Photographs of the Test Configuration.

NOTE:

1. The methods of conformance testing were selected according to EN55022: 2006+A1: 2007, section: 9.6.1 of measurement method using an ISN with a longitudinal conversion loss (LCL) as defined in section: 9.6.2.
2. When measurements were performed on a single unscreened balanced pair, an adequate ISN for two wires were used; when performed on unscreened cables containing two balanced pairs, an adequate ISN for four wires were used.
3. The communication function of EUT was executed and ISN was connected between EUT and associated equipment and the ISN was connected directly to reference ground plane.

4.2.6 EUT OPERATING CONDITIONS

Ethernet connection was better than 10% utilization by command PING or TfGen.

4.2.7 TEST RESULTS

INPUT POWER	230 Vac, 50 Hz	6dB BANDWIDTH	9 kHz
ENVIRONMENTAL CONDITIONS	22 deg. C, 66% RH, 980 hPa	TEST MODE	Shielded RJ45 cable with ISN (10 Mbps)
TESTED BY	Kevin Chen		

No	Freq. [MHz]	Corr. Factor (dB)	Reading Value [dB (uV)]		Emission Level [dB (uV)]		Limit [dB (uV)]		Margin (dB)	
			Q.P.	AV.	Q.P.	AV.	Q.P.	A.V.	Q.P.	A.V.
1	0.388	9.75	40.86	-	50.61	-	76.10	66.10	-25.49	-
2	0.517	9.74	38.80	-	48.54	-	74.00	64.00	-25.46	-
3	0.775	9.77	38.04	-	47.81	-	74.00	64.00	-26.19	-
4	1.355	9.81	36.49	-	46.30	-	74.00	64.00	-27.70	-
5	10.000	9.93	33.57	-	43.50	-	74.00	64.00	-30.50	-
6	18.711	9.98	39.86	-	49.84	-	74.00	64.00	-24.16	-

- REMARKS:**
1. Q.P. and AV. are abbreviations of quasi-peak and average individually.
 2. "-": The Quasi-peak reading value also meets average limit and measurement with the average detector is unnecessary.
 3. The emission levels of other frequencies were very low against the limit.
 4. Margin value = Emission level - Limit value
 5. Correction factor = Insertion loss + Cable loss
 6. Emission Level = Correction Factor + Reading Value.

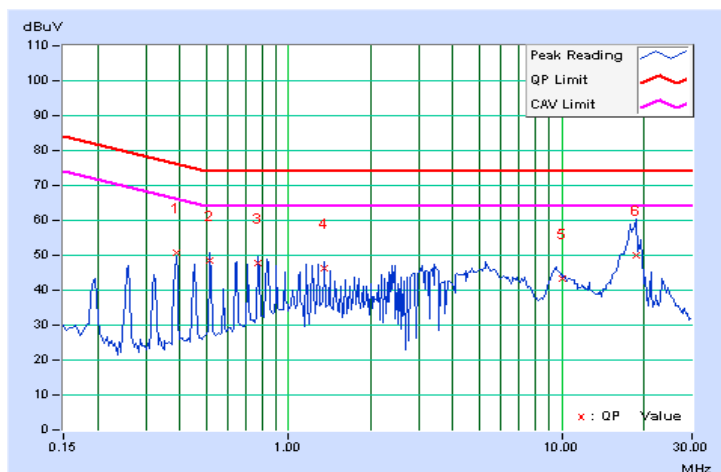

INPUT POWER	230 Vac, 50 Hz	6dB BANDWIDTH	9 kHz
ENVIRONMENTAL CONDITIONS	22 deg. C, 66% RH, 980 hPa	TEST MODE	Shielded RJ45 cable with ISN (100 Mbps)
TESTED BY	Kevin Chen		

No	Freq. [MHz]	Corr. Factor (dB)	Reading Value [dB (uV)]		Emission Level [dB (uV)]		Limit [dB (uV)]		Margin (dB)	
			Q.P.	AV.	Q.P.	AV.	Q.P.	A.V.	Q.P.	A.V.
1	0.388	9.75	39.01	-	48.76	-	76.10	66.10	-27.34	-
2	0.451	9.75	36.04	-	45.79	-	74.86	64.86	-29.07	-
3	0.713	9.77	34.77	-	44.54	-	74.00	64.00	-29.46	-
4	0.970	9.80	32.71	-	42.51	-	74.00	64.00	-31.49	-
5	2.969	9.86	33.63	-	43.49	-	74.00	64.00	-30.51	-
6	17.871	9.98	42.21	-	52.19	-	74.00	64.00	-21.81	-

- REMARKS:**
1. Q.P. and AV. are abbreviations of quasi-peak and average individually.
 2. "-": The Quasi-peak reading value also meets average limit and measurement with the average detector is unnecessary.
 3. The emission levels of other frequencies were very low against the limit.
 4. Margin value = Emission level - Limit value
 5. Correction factor = Insertion loss + Cable loss
 6. Emission Level = Correction Factor + Reading Value.

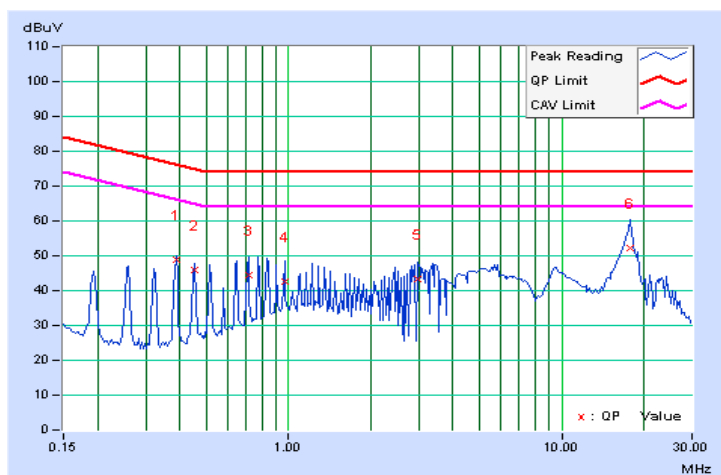

INPUT POWER	230 Vac, 50 Hz	6dB BANDWIDTH	9 kHz
ENVIRONMENTAL CONDITIONS	22 deg. C, 66% RH, 980 hPa	TEST MODE	Shielded RJ45 cable with ISN (1 Gbps)
TESTED BY	Kevin Chen		

No	Freq. [MHz]	Corr. Factor (dB)	Reading Value [dB (uV)]		Emission Level [dB (uV)]		Limit [dB (uV)]		Margin (dB)	
			Q.P.	AV.	Q.P.	AV.	Q.P.	A.V.	Q.P.	A.V.
1	0.388	9.75	39.76	-	49.51	-	76.10	66.10	-26.59	-
2	0.451	9.75	38.56	-	48.31	-	74.86	64.86	-26.55	-
3	0.710	9.77	38.10	-	47.87	-	74.00	64.00	-26.13	-
4	0.968	9.80	31.78	-	41.58	-	74.00	64.00	-32.42	-
5	3.355	9.88	35.67	-	45.55	-	74.00	64.00	-28.45	-
6	17.606	9.98	43.82	-	53.80	-	74.00	64.00	-20.20	-

- REMARKS:**
1. Q.P. and AV. are abbreviations of quasi-peak and average individually.
 2. "-": The Quasi-peak reading value also meets average limit and measurement with the average detector is unnecessary.
 3. The emission levels of other frequencies were very low against the limit.
 4. Margin value = Emission level - Limit value
 5. Correction factor = Insertion loss + Cable loss
 6. Emission Level = Correction Factor + Reading Value.

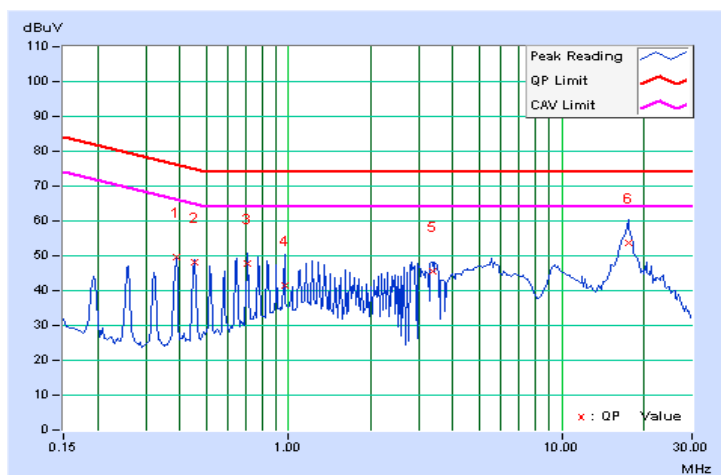

4.3 RADIATED EMISSION MEASUREMENT

4.3.1 LIMITS OF RADIATED EMISSION MEASUREMENT

TEST STANDARD: EN 55022

Frequency (MHz)	Class A (at 10m)	Class B (at 10m)
	Quasi-peak (dBuV/m)	Quasi-peak (dBuV/m)
30-230	40	30
230-1000	47	37

Frequency (MHz)	Class A (at 3m)		Class B (at 3m)	
	Peak (dBuV/m)	Average (dBuV/m)	Peak (dBuV/m)	Average (dBuV/m)
1000-3000	76	56	70	50
3000-6000	80	60	74	54

- NOTE:**
1. The lower limit shall apply at the transition frequencies.
 2. Emission level (dBuV/m) = 20 log Emission level (uV/m).
 3. All emanations from a class A/B digital device or system, including any network of conductors and apparatus connected thereto, shall not exceed the level of field strengths specified above.

FREQUENCY RANGE OF RADIATED MEASUREMENT

Highest frequency generated or used within the EUT or on which the EUT operates or tunes (MHz)	Upper frequency of measurement range (MHz)
Below 108	1000
108-500	2000
500-1000	5000
Above 1000	Up to 5 times of the highest frequency or 6 GHz, whichever is less

4.3.2 TEST INSTRUMENTS

For frequency below 1 GHz

DESCRIPTION & MANUFACTURER	MODEL NO.	SERIAL NO.	DATE OF CALIBRATION	DUE DATE OF CALIBRATION
Test Receiver ROHDE & SCHWARZ	ESIB7	100186	Dec. 05, 2008	Dec. 04, 2009
Test Receiver ROHDE & SCHWARZ	ESIB7	100187	Sep. 22, 2008	Sep. 21, 2009
Spectrum Analyzer ROHDE & SCHWARZ	FSP40	100025	Oct. 22, 2008	Oct. 21, 2009
BILOG Antenna SCHWARZBECK	VULB9168	9168-148	Apr. 28, 2009	Apr. 27, 2010
BILOG Antenna SCHWARZBECK	VULB9168	9168-149	Apr. 28, 2009	Apr. 27, 2010
Preamplifier Agilent	8447D	2944A10637	Dec. 04, 2008	Dec. 03, 2009
Preamplifier Agilent	8447D	2944A10636	Dec. 04, 2008	Dec. 03, 2009
RF signal cable Woken	8D-FB	Cable-Hych1-01	Oct. 28, 2008	Oct. 27, 2009
RF signal cable Woken	8D-FB	Cable-Hych1-02	Oct. 28, 2008	Oct. 27, 2009
Software ADT	ADT_Radiated_ V 7.7.03.6	NA	NA	NA
Antenna Tower(V)	MFA-440	9707	NA	NA
Antenna Tower(H)	MFA-440	970705	NA	NA
Turn Table	DS430	50303	NA	NA
Controller	MF7802	074	NA	NA
Controller	MF7802	08093	NA	NA
RF signal cable EAST COST Microwave	HP 160S-29	NA	Feb. 17, 2009	Feb. 16, 2010

- NOTE:**
1. The calibration interval of the above test instruments is 12 months and the calibrations are traceable to NML/ROC and NIST/USA.
 2. The test was performed in HwaYa Chamber 1.
 3. The FCC Site Registration No. is 477732.
 4. The IC Site Registration No. is IC 7450F-1.
 5. The VCCI Site Registration No. is R-1893.

For frequency above 1 GHz

DESCRIPTION & MANUFACTURER	MODEL NO.	SERIAL NO.	DATE OF CALIBRATION	DUE DATE OF CALIBRATION
Test Receiver ROHDE & SCHWARZ	ESIB7	100188	Dec. 22, 2008	Dec. 21, 2009
Spectrum Analyzer ROHDE & SCHWARZ	FSP40	100025	Oct. 22, 2008	Oct. 21, 2009
BILOG Antenna SCHWARZBECK	VULB9168	9168-157	Apr. 28, 2009	Apr. 27, 2010
HORN Antenna SCHWARZBECK	BBHA 9120 D	9120D-405	Jan. 12, 2009	Jan. 11, 2010
HORN Antenna SCHWARZBECK	BBHA 9170	BBHA9170148	Jul. 06, 2009	Jul. 05, 2010
Preamplifier Agilent	8449B	3008A01961	Oct. 03, 2008	Oct. 02, 2009
Preamplifier Agilent	8447D	2944A10629	Oct. 23, 2008	Oct. 22, 2009
RF signal cable HUBER+SUHNER	SUCOFLEX 104	23636/6	Aug. 21, 2008	Aug. 20, 2009
RF signal cable HUBER+SUHNER	SUCOFLEX 104	283402/4	Aug. 21, 2008	Aug. 20, 2009
Software ADT.	ADT_Radiated_ V7.6.15.9.2	NA	NA	NA
Antenna Tower ADT.	AT100	AT93021702	NA	NA
Turn Table ADT.	TT100.	TT93021702	NA	NA
Controller ADT.	SC100.	SC93021702	NA	NA

- NOTE:**
1. The calibration interval of the above test instruments is 12 months and the calibrations are traceable to NML/ROC and NIST/USA.
 2. The test was performed in HwaYa Chamber 2.
 3. The horn antenna and HP preamplifier (model: 8449B) are used only for the measurement of emission frequency above 1GHz if tested.
 4. The FCC Site Registration No. is 686814.
 5. The IC Site Registration No. is IC 7450F-2.
 6. The VCCI Site Registration No. is G-18.

4.3.3 TEST PROCEDURE

- a. The EUT was placed on the top of a rotating table 0.8 meters above the ground at a 10 meter semi-anechoic chamber room. The table was rotated 360 degrees to determine the position of the highest radiation. The EUT was set 10 meters away from the interference-receiving antenna, which was mounted on the top of a variable-height antenna tower. **<Frequency Range below 1GHz>**
- b. The EUT was placed on the top of a rotating table 0.8 meters above the ground at a 3 meter semi-anechoic chamber room. The table was rotated 360 degrees to determine the position of the highest radiation. The EUT was set 3 meters away from the interference-receiving antenna, which was mounted on the top of a variable-height antenna tower. **<Frequency Range above 1GHz>**
- c. The height of antenna is varied from one meter to four meters above the ground to determine the maximum value of the field strength. Both horizontal and vertical polarizations of the antenna are set to make the measurement.
- d. For each suspected emission, the EUT was arranged to its worst case and then the antenna was tuned to heights from 1 meter to 4 meters and the rotatable table was turned from 0 degrees to 360 degrees to find the maximum reading.
- e. The test-receiver system was set to quasi-peak detect function and specified bandwidth with maximum hold mode when the test frequency is below 1 GHz.
- f. The test-receiver system was set to peak and average detect function and specified bandwidth with maximum hold mode when the test frequency is above 1 GHz.

NOTE:

1. The resolution bandwidth of test receiver/spectrum analyzer is 120 kHz for Quasi-peak detection (QP) at frequency below 1 GHz.
2. The resolution bandwidth is 1MHz and video bandwidth of test receiver/spectrum analyzer is 3 MHz for Peak (PK) detection at frequency above 1 GHz. The resolution bandwidth of test receiver/spectrum analyzer is 1 MHz for Average (AV) detection at frequency above 1 GHz.
3. For measurement of frequency above 1000 MHz, the EUT was set 3 meters away from the receiver antenna.

4.3.4 DEVIATION FROM TEST STANDARD

No deviation.

4.3.5 TEST SETUP

For frequency below 1 GHz

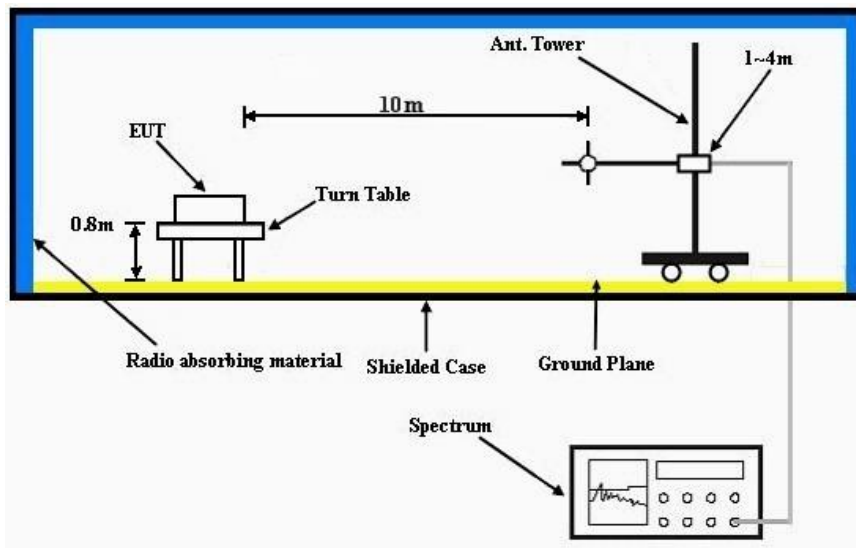

For frequency above 1 GHz

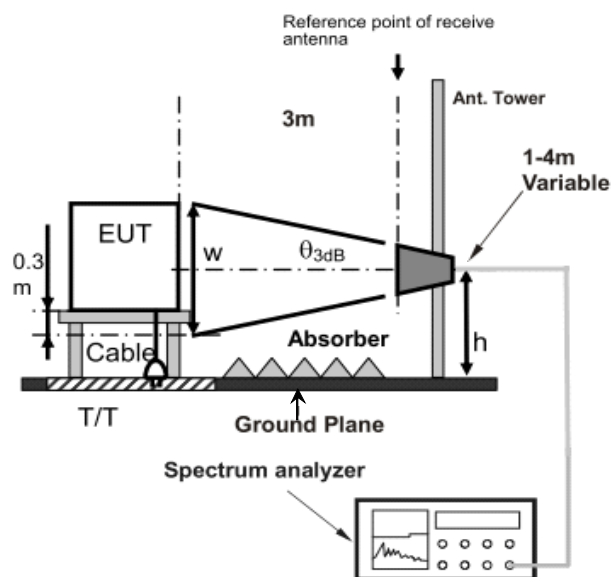

For the actual test configuration, please refer to the related item – Photographs of the Test Configuration.

4.3.6 EUT OPERATING CONDITIONS

Same as item 4.1.6.

4.3.7 TEST RESULTS

ENVIRONMENTAL CONDITIONS	25 deg. C, 66% RH, 980 hPa	FREQUENCY RANGE	30-1000 MHz
DETECTOR FUNCTION & BANDWIDTH	Quasi-Peak, 120 kHz	TESTED BY	Sam Chang

ANTENNA POLARITY & TEST DISTANCE: HORIZONTAL AT 10 m								
No.	Freq. (MHz)	Emission Level (dBuV/m)	Limit (dBuV/m)	Margin (dB)	Antenna Height (m)	Table Angle (Degree)	Raw Value (dBuV)	Correction Factor (dB/m)
1	240.04	30.31 QP	37.00	-6.69	3.50 H	185	17.74	12.57
2	399.34	30.18 QP	37.00	-6.82	2.00 H	73	12.70	17.48
3	480.98	31.52 QP	37.00	-5.48	2.50 H	134	12.36	19.16
4	624.83	32.47 QP	37.00	-4.53	1.50 H	336	10.10	22.37
5	751.18	30.31 QP	37.00	-6.69	3.50 H	286	6.03	24.28
6	875.59	31.53 QP	37.00	-5.47	1.00 H	15	5.49	26.04

- REMARKS:**
1. Emission level(dBuV/m)=Raw Value(dBuV) + Correction Factor(dB/m)
 2. Correction Factor(dB/m) = Antenna Factor (dB/m) + Cable Factor (dB)
 3. The other emission levels were very low against the limit.
 4. Margin value = Emission level – Limit value.

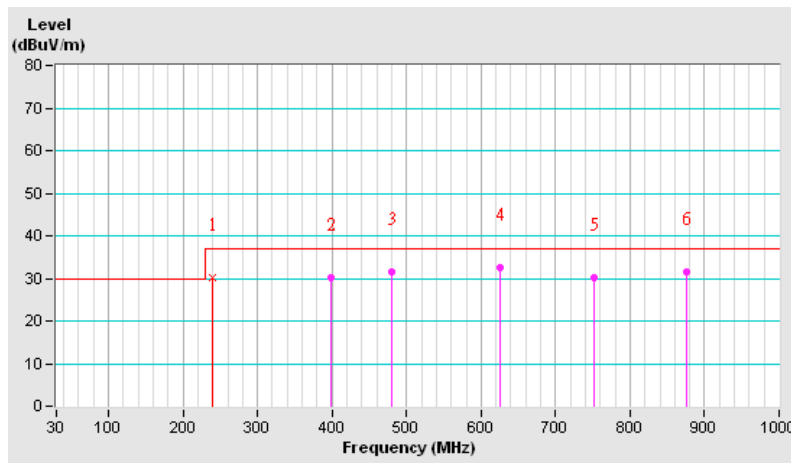

ENVIRONMENTAL CONDITIONS	25 deg. C, 66% RH, 980 hPa	FREQUENCY RANGE	30-1000 MHz
DETECTOR FUNCTION & BANDWIDTH	Quasi-Peak, 120 kHz	TESTED BY	Sam Chang

ANTENNA POLARITY & TEST DISTANCE: VERTICAL AT 10 m								
No.	Freq. (MHz)	Emission Level (dBuV/m)	Limit (dBuV/m)	Margin (dB)	Antenna Height (m)	Table Angle (Degree)	Raw Value (dBuV)	Correction Factor (dB/m)
1	149.96	20.52 QP	30.00	-9.48	1.50 V	321	6.40	14.12
2	180.32	25.75 QP	30.00	-4.25	1.00 V	68	13.19	12.56
3	195.23	25.85 QP	30.00	-4.15	1.00 V	119	14.20	11.65
4	480.98	28.06 QP	37.00	-8.94	1.50 V	304	8.19	19.87
5	624.83	28.28 QP	37.00	-8.72	1.50 V	100	5.28	23.00
6	875.59	29.84 QP	37.00	-7.16	4.00 V	134	2.64	27.20

- REMARKS:**
1. Emission level(dBuV/m)=Raw Value(dBuV) + Correction Factor(dB/m)
 2. Correction Factor(dB/m) = Antenna Factor (dB/m) + Cable Factor (dB)
 3. The other emission levels were very low against the limit.
 4. Margin value = Emission level – Limit value.

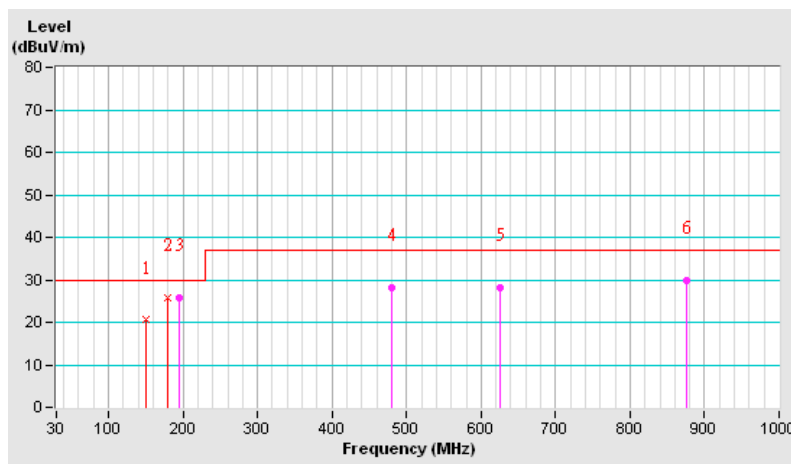

INPUT POWER	230 Vac, 50 Hz	FREQUENCY RANGE	1-6 GHz
ENVIRONMENTAL CONDITIONS	24 deg. C, 62% RH, 980 hPa	DETECTOR FUNCTION & BANDWIDTH	Peak/Average, 1 MHz
TESTED BY	Peter Lin		

ANTENNA POLARITY & TEST DISTANCE: HORIZONTAL AT 3 m								
No.	Freq. (MHz)	Emission Level (dBuV/m)	Limit (dBuV/m)	Margin (dB)	Antenna Height (m)	Table Angle (Degree)	Raw Value (dBuV)	Correction Factor (dB/m)
1	1800.00	49.49 PK	70.00	-20.51	1.25 H	116	20.88	28.61
2	1800.00	31.64 AV	50.00	-18.36	1.25 H	116	3.03	28.61
3	2000.01	56.15 PK	70.00	-13.85	2.00 H	360	27.15	29.00
4	2000.01	36.98 AV	50.00	-13.02	2.00 H	360	7.98	29.00
5	2800.01	53.39 PK	70.00	-16.61	1.25 H	109	21.83	31.56
6	2800.01	46.79 AV	50.00	-3.21	1.25 H	109	15.23	31.56
7	2999.88	50.68 PK	70.00	-19.32	1.00 H	228	18.60	32.08
8	2999.88	40.55 AV	50.00	-9.45	1.00 H	228	8.47	32.08
9	3599.84	55.44 PK	74.00	-18.56	1.00 H	183	22.39	33.05
10	3599.84	46.23 AV	54.00	-7.77	1.00 H	183	13.18	33.05

- REMARKS:**
1. Emission level(dBuV/m)=Raw Value(dBuV) + Correction Factor(dB/m)
 2. Correction Factor(dB/m) = Antenna Factor (dB/m) + Cable Factor (dB)
 3. The other emission levels were very low against the limit.
 4. Margin value = Emission level – Limit value.

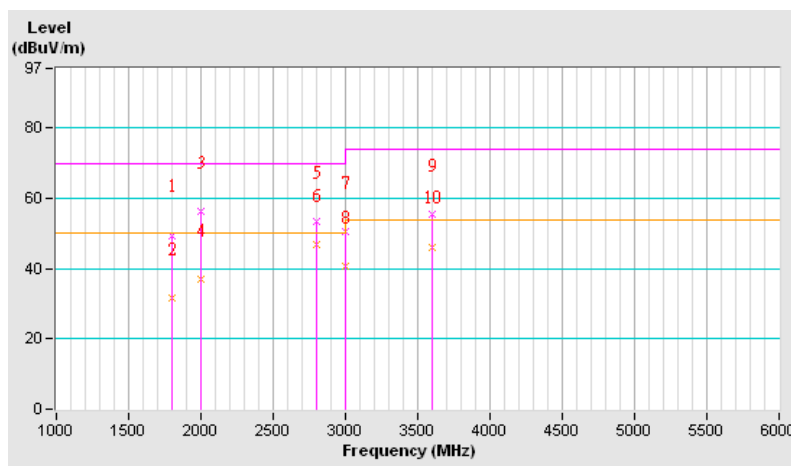

INPUT POWER	230 Vac, 50 Hz	FREQUENCY RANGE	1-6 GHz
ENVIRONMENTAL CONDITIONS	24 deg. C, 62% RH, 980 hPa	DETECTOR FUNCTION & BANDWIDTH	Peak/Average, 1 MHz
TESTED BY	Peter Lin		

ANTENNA POLARITY & TEST DISTANCE: VERTICAL AT 3 m								
No.	Freq. (MHz)	Emission Level (dBuV/m)	Limit (dBuV/m)	Margin (dB)	Antenna Height (m)	Table Angle (Degree)	Raw Value (dBuV)	Correction Factor (dB/m)
1	1399.58	52.10 PK	70.00	-17.90	1.00 V	274	24.46	27.64
2	1399.58	31.21 AV	50.00	-18.79	1.00 V	274	3.57	27.64
3	1800.00	52.29 PK	70.00	-17.71	1.00 V	121	23.68	28.61
4	1800.00	32.76 AV	50.00	-17.24	1.00 V	121	4.15	28.61
5	1999.98	54.39 PK	70.00	-15.61	1.00 V	360	25.39	29.00
6	1999.98	36.65 AV	50.00	-13.35	1.00 V	360	7.65	29.00
7	2799.99	48.86 PK	70.00	-21.14	1.00 V	107	17.30	31.56
8	2799.99	44.76 AV	50.00	-5.24	1.00 V	107	13.20	31.56
9	2999.93	50.71 PK	70.00	-19.29	1.00 V	183	18.63	32.08
10	2999.93	39.64 AV	50.00	-10.36	1.00 V	183	7.56	32.08

- REMARKS:**
1. Emission level(dBuV/m)=Raw Value(dBuV) + Correction Factor(dB/m)
 2. Correction Factor(dB/m) = Antenna Factor (dB/m) + Cable Factor (dB)
 3. The other emission levels were very low against the limit.
 4. Margin value = Emission level – Limit value.

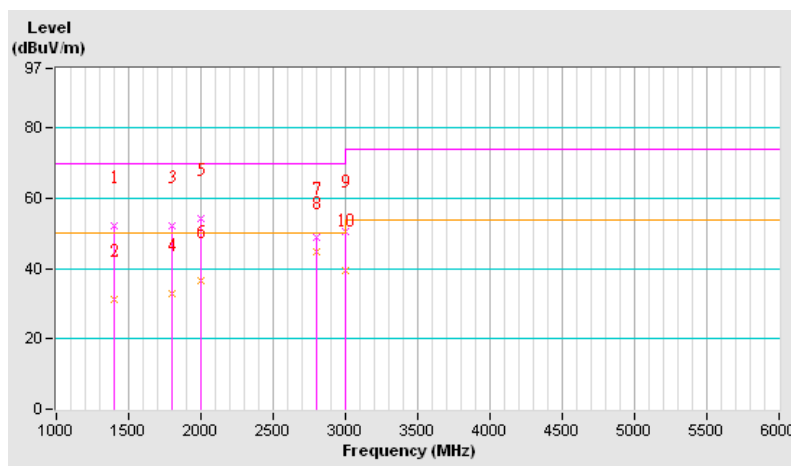

4.4 HARMONICS CURRENT MEASUREMENT

4.4.1 LIMITS OF HARMONICS CURRENT MEASUREMENT

TEST STANDARD: EN 61000-3-2

Limits for Class A equipment	
Harmonics Order n	Max. permissible harmonics current A
Odd harmonics	
3	2.30
5	1.14
7	0.77
9	0.40
11	0.33
13	0.21
15<=n<=39	0.15x15/n
Even harmonics	
2	1.08
4	0.43
6	0.30
8<=n<=40	0.23x8/n

Limits for Class D equipment		
Harmonics Order n	Max. permissible harmonics current per watt mAW	Max. permissible harmonics current A
Odd Harmonics only		
3	3.4	2.30
5	1.9	1.14
7	1.0	0.77
9	0.5	0.40
11	0.35	0.33
13	0.30	0.21
15<=n<=39	3.85/n	0.15x15/n

NOTE: 1. Class A and Class D are classified according to item section 5 of EN 61000-3-2.

2. According to section 7 of EN 61000-3-2, the above limits for all equipment except for lighting equipment having an active input power > 75 W and no limits apply for equipment with an active input power up to and including 75 W.

4.4.2 TEST INSTRUMENTS

DESCRIPTION & MANUFACTURER	MODEL NO.	SERIAL NO.	DATE OF CALIBRATION	DUE DATE OF CALIBRATION
Schaffner AC Power Source	NSG1007	55616	Nov. 06, 2008	Nov. 05, 2009
Schaffner Signal Conditioning Unit- Lumped Impedance	CCN1000-1-LR1	72224	Nov. 06, 2008	Nov. 05, 2009
Software	Schaffner Win 2100V3	NA	NA	NA

NOTE: 1. The test was performed in Hwa Ya EMS Room.

2. The calibration interval of the above test instruments is 12 months and the calibrations are traceable to NML/ROC and NIST/USA.

4.4.3 TEST PROCEDURE

- a. The EUT was placed on the top of a wooden table 0.8 meters above the ground and operated to produce the maximum harmonic components under normal operating conditions for each successive harmonic component in turn.
- b. The classification of EUT is according to section 5 of EN 61000-3-2.

The EUT is classified as follows:

Class A: Balanced three-phase equipment, Household appliances excluding equipment as Class D, Tools excluding portable tools, Dimmers for incandescent lamps, audio equipment, equipment not specified in one of the three other classes.

Class B: Portable tools. Arc welding equipment which is not professional equipment.

Class C: Lighting equipment.

Class D: Equipment having a specified power less than or equal to 600 W of the following types: Personal computers, personal computer monitors and TV receivers.

- c. The correspondent test program of test instrument to measure the current harmonics emanated from EUT is chosen. The measure time shall be not less than the time necessary for the EUT to be exercised.

4.4.4 DEVIATION FROM TEST STANDARD

No deviation.

4.4.5 TEST SETUP

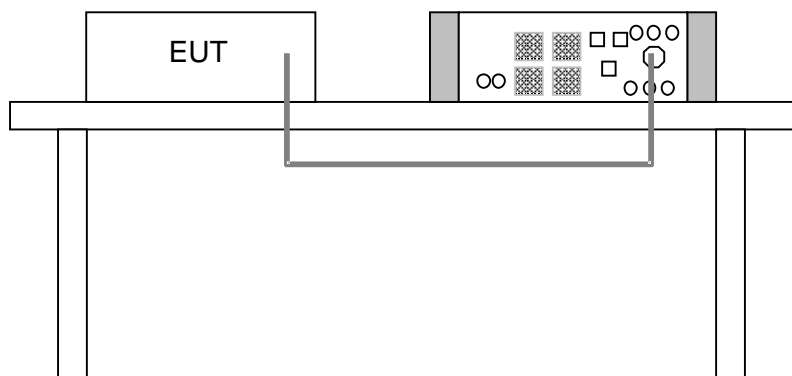

For the actual test configuration, please refer to the related item – Photographs of the Test Configuration.

4.4.6 EUT OPERATING CONDITIONS

- a. The notebook ran a test program to enable all functions.
- b. The notebook communicated data with the EUT and external HDDs.

4.4.7 TEST RESULTS

FUNDAMENTAL VOLTAGE/AMPERE	230.08 Vrms 0.120 Amps	POWER FREQUENCY	50.00 Hz
RATED POWER CONSUMPTION	29.3 W	POWER FACTOR	0.346
ENVIRONMENTAL CONDITIONS	25 deg. C, 54% RH, 980 hPa	TESTED BY	Jn Chen

- NOTE:** 1.Limits are not specified for equipment with a rated power of 75W or less (other than lighting equipment).
- 2.The EUT is not required to meet this test item as its power consumption is lower than 75W.

4.5 VOLTAGE FLUCTUATION AND FLICKS MEASUREMENT

4.5.1 LIMITS OF VOLTAGE FLUCTUATION AND FLICKS MEASUREMENT

TEST STANDARD: EN 61000-3-3

Test Item	Limit	Note
Pst	1.0	Pst means short-term flicker indicator.
Plt	0.65	Plt means long-term flicker indicator.
Tdt (ms)	500	Tdt means maximum time that dt exceeds 3.3 %.
dmax (%)	4%	dmax means maximum relative voltage change.
dc (%)	3.3%	dc means relative steady-state voltage change

4.5.2 TEST INSTRUMENTS

DESCRIPTION & MANUFACTURER	MODEL NO.	SERIAL NO.	DATE OF CALIBRATION	DUE DATE OF CALIBRATION
Schaffner AC Power Source	NSG1007	55616	Nov. 06, 2008	Nov. 05, 2009
Schaffner Signal Conditioning Unit- Lumped Impedance	CCN1000-1-LR1	72224	Nov. 06, 2008	Nov. 05, 2009
Software	Schaffner Win 2100V3	NA	NA	NA

NOTE: 1. The test was performed in Hwa Ya EMS Room.

2. The calibration interval of the above test instruments is 12 months and the calibrations are traceable to NML/ROC and NIST/USA.

4.5.3 TEST PROCEDURE

- a. The EUT was placed on the top of a wooden table 0.8 meters above the ground and operated to produce the most unfavorable sequence of voltage changes under normal operating conditions.
- b. During the flick measurement, the measure time shall include that part of whole operation cycle in which the EUT produce the most unfavorable sequence of voltage changes. The observation period for short-term flicker indicator is 10 minutes and the observation period for long-term flicker indicator is 2 hours.

4.5.4 DEVIATION FROM TEST STANDARD

No deviation.

4.5.5 TEST SETUP

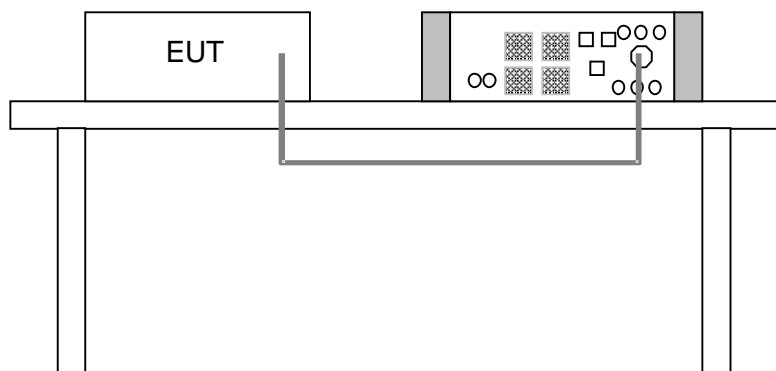

For the actual test configuration, please refer to the related item – Photographs of the Test Configuration.

4.5.6 EUT OPERATING CONDITIONS

Same as item 4.4.6.

4.5.7 TEST RESULTS

FUNDAMENTAL VOLTAGE/AMPERE	230.13 Vrms 0.120 Amps	POWER FREQUENCY	50.00 Hz
ENVIRONMENTAL CONDITIONS	25 deg. C, 54% RH, 980 hPa	POWER FACTOR	0.346
OBSERVATION PERIOD (Tp)	10 mins	TESTED BY	Jn Chen

Test Parameter	Measurement Value	Limit	Remark
P _{st}	0.226	1.0	PASS
P _{lt}	0.099	0.65	PASS
T _{dt} (ms)	0	500	PASS
d _{max} (%)	0	4%	PASS
dc (%)	0.14	3.3%	PASS

- NOTE:** 1. P_{st} means short-term flicker indicator.
 2. P_{lt} means long-term flicker indicator.
 3. T_{dt} means maximum time that dt exceeds 3.3 %.
 4. d_{max} means maximum relative voltage change.
 5. dc means relative steady-state voltage change.

5.2 GENERAL PERFORMANCE CRITERIA DESCRIPTION

According to Clause 7.1 of EN 55024 standard, the following describes the general performance criteria.

<p>Criterion A</p>	<p>The equipment shall continue to operate as intended without operator intervention. No degradation of performance or loss of function is allowed below a performance level specified by the manufacturer when the equipment is used as intended. The performance level may be replaced by a permissible loss of performance. If the minimum performance level or the permissible performance loss is not specified by the manufacturer, then either of these may be derived from the product description and documentation, and by what the user may reasonably expect from the equipment if used as intended.</p>
<p>Criterion B</p>	<p>After the test, the equipment shall continue to operate as intended without operator intervention. No degradation of performance or loss of function is allowed, after the application of the phenomenon below a performance level specified by the manufacturer, when the equipment is used as intended. The performance level may be replaced by a permissible loss of performance.</p> <p>During the test, degradation of performance is allowed. However, no change of operating state if stored data is allowed to persist after the test. If the minimum performance level (or the permissible performance loss) is not specified by the manufacturer, then either of these may be derived from the product description and documentation, and by what the user may reasonably expect from the equipment if used as intended.</p>
<p>Criterion C</p>	<p>Loss of function is allowed, provided the function is self-recoverable, or can be restored by the operation of the controls by the user in accordance with the manufacturer's instructions.</p> <p>Functions, and/or information stored in non-volatile memory, or protected by a battery backup, shall not be lost.</p>

5.3 PARTICULAR PERFORMANCE CRITERIA DESCRIPTION FOR READ, WRITE AND STORAGE OF DATA FUNCTION

Criterion A	Storage devices shall maintain normal operation both in read/write and in stand-by conditions.
Criterion B	Failures which can be recovered by read and write retries are permissible (temporary delay in processing caused by this process is acceptable). Normal operation of the EUT shall be restored after the test, self-recovery to the conditions immediately prior to the application of the test is accepted where this is a normal means of recovery. In these cases, operator response is permitted to re-initialise an operation.
Criterion C	Failures resulting in a delay in processing after the external disturbance is removed, but which can be recovered to normal operation by reset or reboot are permissible. Failures resulting in a system abort, which can be recovered to normal operation by reset or reboot are permissible.

5.4 EUT OPERATING CONDITION

Same as item 4.4.6.

5.5 ELECTROSTATIC DISCHARGE IMMUNITY TEST (ESD)

5.5.1 TEST SPECIFICATION

Basic Standard:	IEC 61000-4-2
Discharge Impedance:	330 ohm / 150 pF
Discharge Voltage:	Air Discharge: 2, 4, 8 kV (Direct) Contact Discharge: 2, 4 kV (Direct / Indirect)
Polarity:	Positive & Negative
Number of Discharge:	Air Discharge: min. 20 times at each test point Contact Discharge: min. 50 times at each test point
Discharge Mode:	Single Discharge
Discharge Period:	1 second minimum

5.5.2 TEST INSTRUMENTS

DESCRIPTION & MANUFACTURER	MODEL NO.	SERIAL NO.	DATE OF CALIBRATION	DUE DATE OF CALIBRATION
Schaffner ESD generator	NSG 435	5976	Feb. 03, 2009	Feb. 02, 2010

- NOTE:** 1. The test was performed in Hwa Ya ESD Room No. 1.
2. The calibration interval of the above test instruments is 12 months and the calibrations are traceable to NML/ROC and NIST/USA.

5.5.3 TEST PROCEDURE

The discharges shall be applied in two ways:

a. Contact discharges to the conductive surfaces and coupling planes:

The EUT shall be exposed to at least 200 discharges, 100 each at negative and positive polarity, at a minimum of four test points. One of the test points shall be subjected to at least 50 indirect discharges to the center of the front edge of the horizontal coupling plane. The remaining three test points shall each receive at least 50 direct contact discharges. If no direct contact test points are available, then at least 200 indirect discharges shall be applied in the indirect mode. Test shall be performed at a maximum repetition rate of one discharge per second.

b. Air discharges at slots and apertures and insulating surfaces:

On those parts of the EUT where it is not possible to perform contact discharge testing, the equipment should be investigated to identify user accessible points where breakdown may occur. Such points are tested using the air discharge method. This investigation should be restricted to those area normally handled by the user. A minimum of 10 single air discharges shall be applied to the selected test point for each such area.

The basic test procedure was in accordance with IEC 61000-4-2:

- a. Electrostatic discharges were applied only to those points and surfaces of the EUT that are accessible to users during normal operation.
- b. The test was performed with at least ten single discharges on the pre-selected points in the most sensitive polarity.
- c. The time interval between two successive single discharges was at least 1 second.
- d. The ESD generator was held perpendicularly to the surface to which the discharge was applied and the return cable was at least 0.2 meters from the EUT.
- e. Contact discharges were applied to the non-insulating coating, with the pointed tip of the generator penetrating the coating and contacting the conducting substrate.
- f. Air discharges were applied with the round discharge tip of the discharge electrode approaching the EUT as fast as possible (without causing mechanical damage) to touch the EUT. After each discharge, the ESD generator was removed from the EUT and re-triggered for a new single discharge. The test was repeated until all discharges were complete.
- g. At least ten single discharges (in the most sensitive polarity) were applied to the **Horizontal Coupling Plane** at points on each side of the EUT. The ESD generator was positioned horizontally at a distance of 0.1 meters from the EUT with the discharge electrode touching the **HCP**.
- h. At least ten single discharges (in the most sensitive polarity) were applied to the center of one vertical edge of the **Vertical Coupling Plane** in sufficiently different positions that the four faces of the EUT were completely illuminated. The **VCP** (dimensions 0.5m x 0.5m) was placed vertically to and 0.1 meters from the EUT.

5.5.4 DEVIATION FROM TEST STANDARD

No deviation.

5.5.5 TEST SETUP

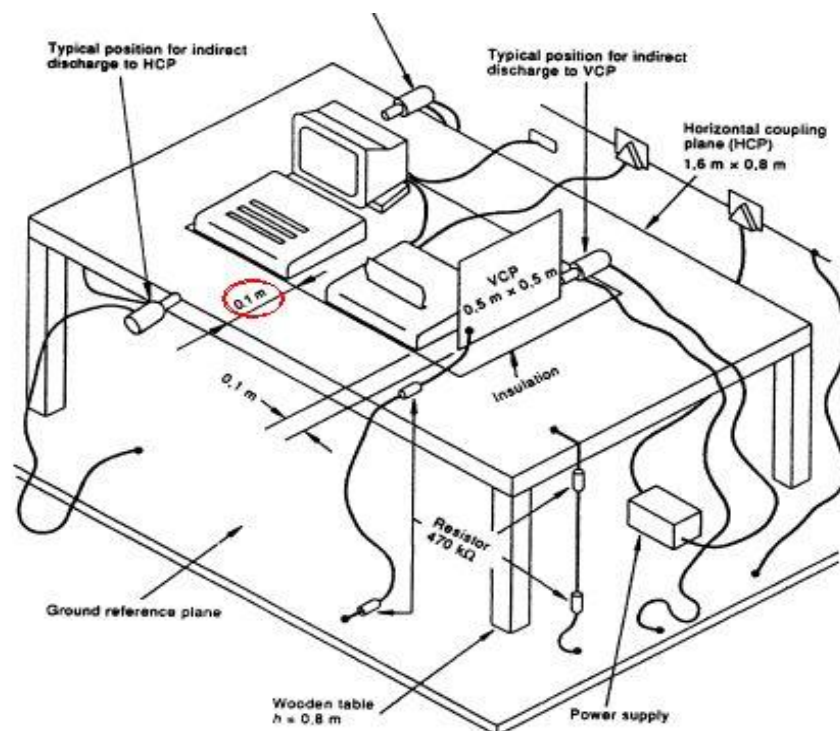

For the actual test configuration, please refer to the related item – Photographs of the Test Configuration.

NOTE:

TABLE-TOP EQUIPMENT

The configuration consisted of a wooden table 0.8 meters high standing on the **Ground Reference Plane**. The **GRP** consisted of a sheet of aluminum at least 0.25mm thick, and 2.5 meters square connected to the protective grounding system. A **Horizontal Coupling Plane** (1.6m x 0.8m) was placed on the table and attached to the **GRP** by means of a cable with 940kΩ total impedance. The equipment under test, was installed in a representative system as described in section 7 of IEC 61000-4-2, and its cables were placed on the **HCP** and isolated by an insulating support of 0.5mm thickness. A distance of 1-meter minimum was provided between the EUT and the walls of the laboratory and any other metallic structure.

FLOOR-STANDING EQUIPMENT

The equipment under test was installed in a representative system as described in section 7 of IEC 61000-4-2, and its cables were isolated from the Ground Reference Plane by an insulating support of 0.1-meter thickness. The GRP consisted of a sheet of aluminum that is at least 0.25mm thick, and 2.5 meters square connected to the protective grounding system and extended at least 0.5 meters from the EUT on all sides.

5.5.6 TEST RESULTS

INPUT POWER	230 Vac, 50 Hz	ENVIRONMENTAL CONDITIONS	25 deg. C, 45% RH 1006 hPa
TESTED BY	Andy Chang		

TEST RESULTS OF DIRECT APPLICATION					
Discharge Level (kV)	Polarity	Test Point	Contact Discharge	Air Discharge	Performance Criterion
2, 4	+/-	1	NOTE 1	NA	A
2, 4, 8	+/-	3, 5	NA	NOTE 1	A
2, 4	+/-	1, 2, 4	NA	NOTE 1	A
8	+/-	1, 2, 4	NA	NOTE 2	B

Description of test point: Please refer to following photos for representative mark only.

TEST RESULTS OF INDIRECT APPLICATION					
Discharge Level (kV)	Polarity	Test Point	Horizontal Coupling Plane	Vertical Coupling Plane	Performance Criterion
2, 4	+/-	4 sides	NOTE 1	NOTE 1	A

Description of test point:

1. Front side 2. Rear side 3. Right side 4. Left side

NOTE:

1. There was no change compared with initial operation during and after the test.
2. The LAN connection broke off during the test, but could self-recover to the initial operation after the test.

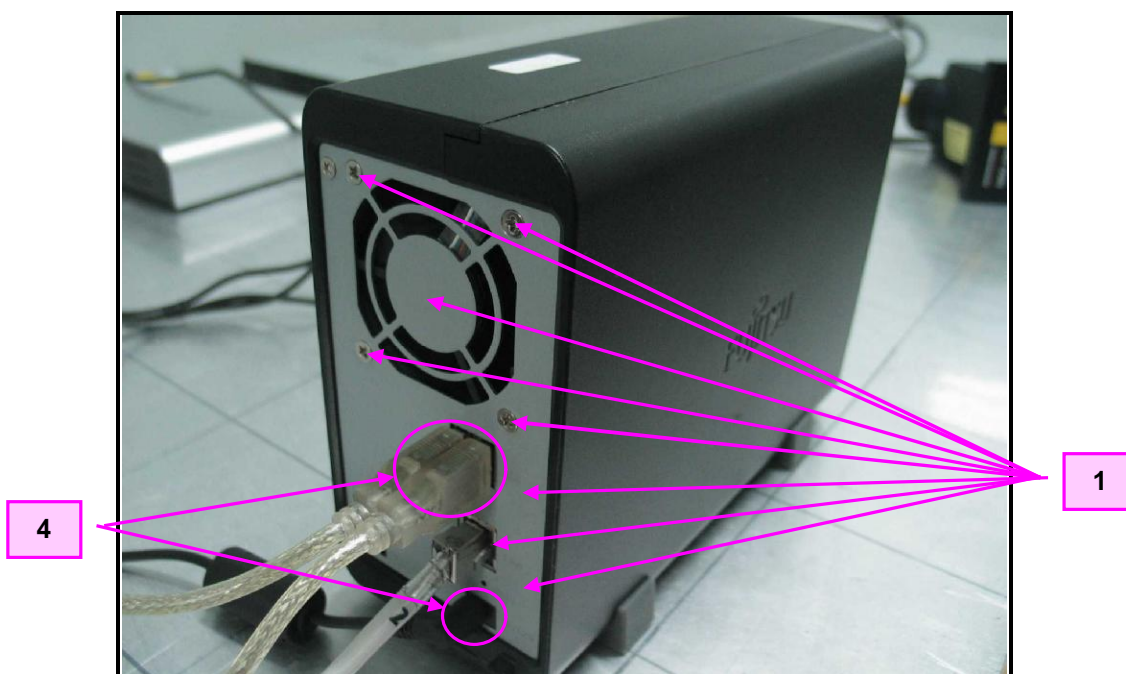
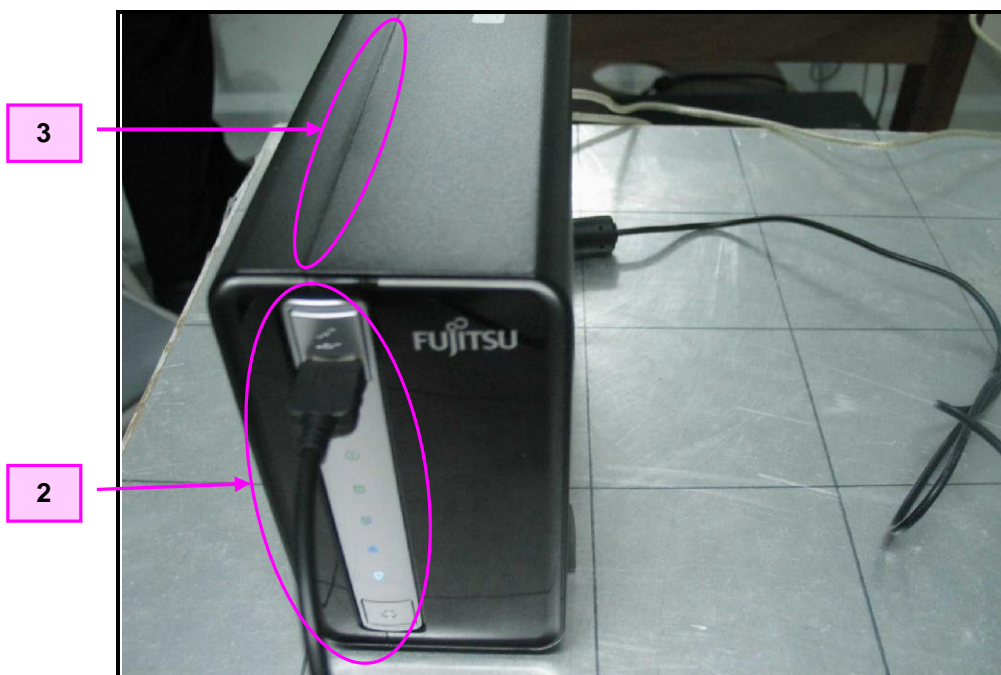

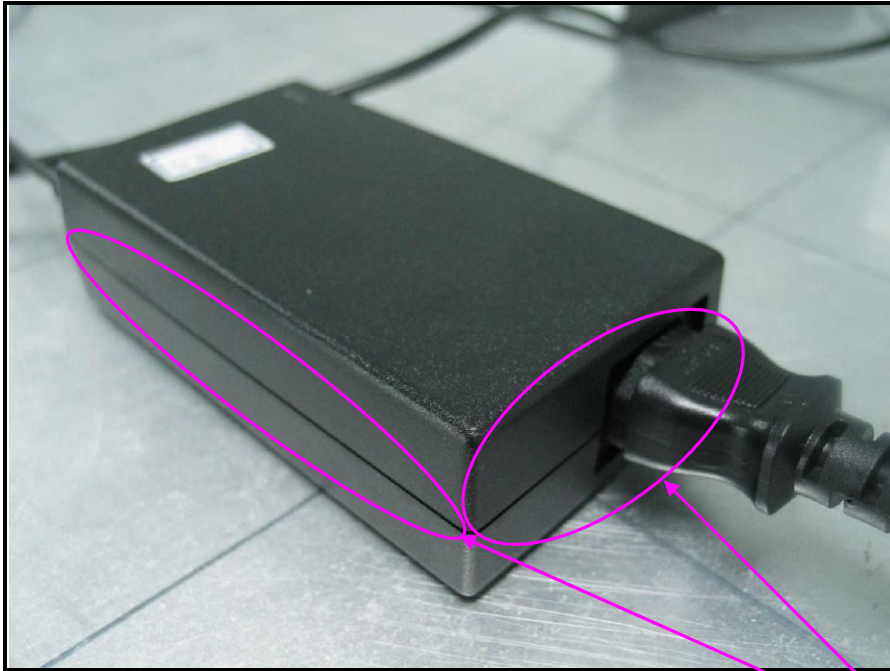

5

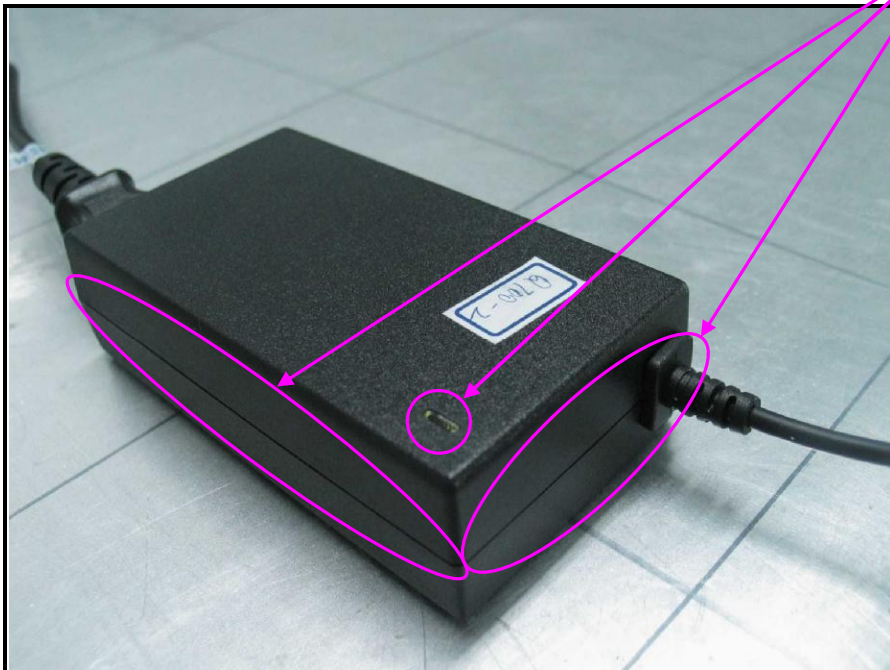

5.6 RADIATED, RADIO-FREQUENCY, ELECTROMAGNETIC FIELD IMMUNITY TEST (RS)

5.6.1 TEST SPECIFICATION

Basic Standard:	IEC 61000-4-3
Frequency Range:	80 MHz ~ 1000 MHz
Field Strength:	3 V/m
Modulation:	1 kHz Sine Wave, 80%, AM Modulation
Frequency Step:	1 % of preceding frequency value
Polarity of Antenna:	Horizontal and Vertical
Antenna Height:	1.5 m
Dwell Time:	3 seconds

5.6.2 TEST INSTRUMENTS

DESCRIPTION & MANUFACTURER	MODEL NO.	SERIAL NO.	DATE OF CALIBRATION	DUE DATE OF CALIBRATION
Boonton RF Power Meter	4232A-01-02	104302	Nov. 03, 2008	Nov. 02, 2009
R&S Signal Generator	SML03	101499	Nov. 27, 2008	Nov. 26, 2009
LOG ANTENNA	AT5080ANT	303730	NA	NA
Amplifier	60S1G3M1	308049	NA	NA
Amplifier RF TEST SYCTRLR	SC1000M1	308057	NA	NA
Amplifier	150W1000	322011	NA	NA
Amplifier	DC7144A	307880	NA	NA
POWER SENSOR	51011-EMC	30028	Nov. 03, 2008	Nov. 02, 2009
POWER SENSOR	51011-EMC	33029	Nov. 03, 2008	Nov. 02, 2009
Software	ADT_RS_V450	NA	NA	NA

- NOTE:**
1. The test was performed in Hwa Ya RS Room.
 2. The calibration interval of the above test instruments is 12 months and the calibrations are traceable to NML/ROC and NIST/USA.
 3. The transmit antenna was located at a distance of 2.0 meters from the EUT. (For frequency range 80MHz ~ 1GHz).

5.6.3 TEST PROCEDURE

The test procedure was in accordance with IEC 61000-4-3

- a. The testing was performed in a fully-anechoic chamber.
- b. The frequency range is swept from 80 MHz to 1000 MHz, with the signal 80% amplitude modulated with a 1 kHz sinewave.
- c. The dwell time at each frequency shall not be less than the time necessary for the EUT to be exercised and to respond, but shall in no case be less than 0.5s.
- d. The field strength level was 3 V/m.
- e. The test was performed with the EUT exposed to both vertically and horizontally polarized fields on each of the four sides.

5.6.4 DEVIATION FROM TEST STANDARD

No deviation.

5.6.5 TEST SETUP

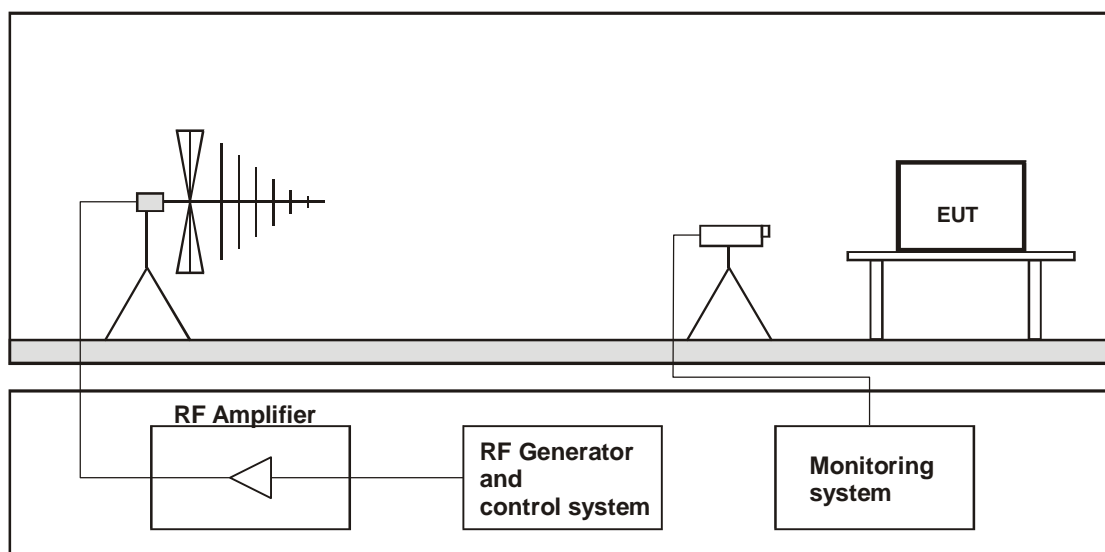

For the actual test configuration, please refer to the related item – Photographs of the Test Configuration.

NOTE:

TABLETOP EQUIPMENT

The EUT installed in a representative system as described in section 7 of IEC 61000-4-3 was placed on a non-conductive table 0.8 meters in height. The system under test was connected to the power and signal wire according to relevant installation instructions.

FLOOR STANDING EQUIPMENT

The EUT installed in a representative system as described in section 7 of IEC 61000-4-3 was placed on a non-conductive wood support 0.1 meters in height. The system under test was connected to the power and signal wire according to relevant installation instructions.

5.6.6 TEST RESULTS

INPUT POWER	230 Vac, 50 Hz	ENVIRONMENTAL CONDITIONS	25 deg. C, 45% RH 1008 hPa
TESTED BY	Dark Su		

Frequency (MHz)	Polarity	Azimuth	Field Strength (V/m)	Observation	Performance Criterion
80-1000	V&H	0, 90, 180, 270	3	NOTE	A

NOTE: There was no change compared with initial operation during and after the test.

5.7 ELECTRICAL FAST TRANSIENT/BURST IMMUNITY TEST (EFT)

5.7.1 TEST SPECIFICATION

Basic Standard:	IEC 61000-4-4
Test Voltage:	Power line: 1 kV Signal line: 0.5 kV
Polarity:	Positive & Negative
Impulse Frequency:	5 kHz
Impulse Waveshape:	5/50 ns
Burst Duration:	15 ms
Burst Period:	300 ms
Test Duration:	1 min.

5.7.2 TEST INSTRUMENTS

DESCRIPTION & MANUFACTURER	MODEL NO.	SERIAL NO.	DATE OF CALIBRATION	DUE DATE OF CALIBRATION
EMC-Partner EFT Generator	TRA2000EFT-C1	623	Sep. 16, 2008	Sep. 15, 2009
EMC-Partner Capacitive Coupling clamp	CN-EFT1000	364	NA	NA
EFT Adapter WONPRO	WA	EF1Ada-001	NA	NA
Software	EMC-Partner GENECS	NA	NA	NA

- NOTE:** 1. The test was performed in Hwa Ya EFT Room.
2. The calibration interval of the above test instruments is 12 months and the calibrations are traceable to NML/ROC and NIST/USA.

5.7.3 TEST PROCEDURE

- Both positive and negative polarity discharges were applied.
- The length of the "hot wire" from the coaxial output of the EFT generator to the terminals on the EUT was 0.5 m.
- The duration time of each test sequential was 1 minute.
- The transient/burst waveform was in accordance with IEC 61000-4-4, 5/50ns.

5.7.4 DEVIATION FROM TEST STANDARD

No deviation.

5.7.5 TEST SETUP

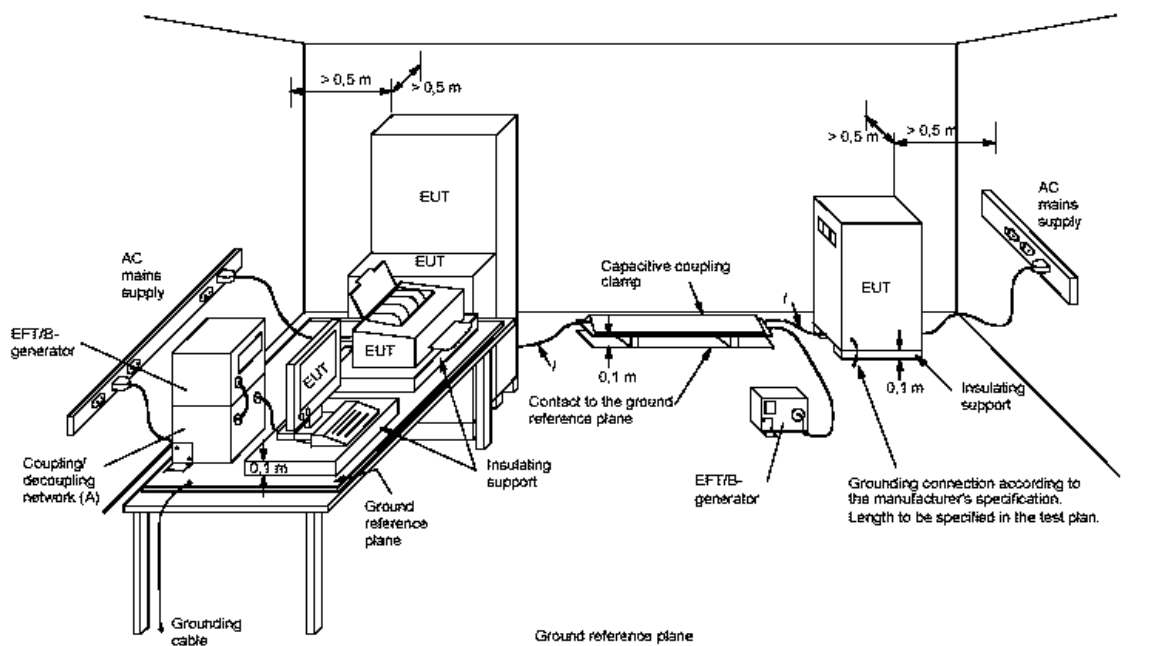

NOTE:

/ length between clamp and the EUT to be tested (should be $0.5 \text{ m} \pm 0.05 \text{ m}$)

(A) location for supply line coupling

(B) location for signal lines coupling

For the actual test configuration, please refer to the related item – Photographs of the Test Configuration.

NOTE:

EUTs, whether stationary floor-mounted or table top, and equipment designed to be mounted in other configurations, shall be placed on a ground reference plane and shall be insulated from it by an insulating support $0.1 \text{ m} \pm 0.01 \text{ m}$ thick. A minimum distance of 0.5m was provided between the EUT and the walls of the laboratory or any other metallic structure.

5.7.6 TEST RESULTS

INPUT POWER	230 Vac, 50 Hz	ENVIRONMENTAL CONDITIONS	25 deg. C, 45% RH 1008 hPa
TESTED BY	Jn Chen		

Test Point	Polarity	Test Level (kV)	Observation	Performance Criterion
L1	+/-	1	NOTE	A
L2	+/-	1	NOTE	A
PE	+/-	1	NOTE	A
L1-L2-PE	+/-	1	NOTE	A
LAN	+/-	0.5	NOTE	A

NOTE: There was no change compared with initial operation during and after the test.

5.8 SURGE IMMUNITY TEST

5.8.1 TEST SPECIFICATION

Basic Standard:	IEC 61000-4-5
Wave-Shape:	Combination Wave 1.2/50 us Open Circuit Voltage 8 /20 us Short Circuit Current
Test Voltage:	Power port: 0.5, 1, 2 kV
Surge Input/Output:	L1-L2, L1-PE, L2-PE
Generator Source Impedance:	2 ohm between networks 12 ohm between network and ground
Polarity:	Positive/Negative
Phase Angle:	0°/90°/180°/270°
Pulse Repetition Rate:	1 time / min
Number of Tests:	5 positive and 5 negative at selected points

5.8.2 TEST INSTRUMENTS

DESCRIPTION & MANUFACTURER	MODEL NO.	SERIAL NO.	DATE OF CALIBRATION	DUE DATE OF CALIBRATION
EMC Immunity Tester	TRANSIENT 2000	622	Aug. 03, 2009	Aug. 02, 2010

- NOTE:** 1. The test was performed in Hwa Ya Surge Room.
2. The calibration interval of the above test instruments is 12 months and the calibrations are traceable to NML/ROC and NIST/USA.

5.8.3 TEST PROCEDURE

a. For EUT power supply:

The surge is to be applied to the EUT power supply terminals via the capacitive coupling network. Decoupling networks are required in order to avoid possible adverse effects on equipment not under test that may be powered by the same lines, and to provide sufficient decoupling impedance to the surge wave. The power cord between the EUT and the coupling/decoupling networks shall be 2 meters in length (or shorter).

b. For test applied to unshielded unsymmetrically operated interconnection lines of EUT:

The surge is applied to the lines via the capacitive coupling. The coupling / decoupling networks shall not influence the specified functional conditions of the EUT. The interconnection line between the EUT and the coupling/decoupling networks shall be 2 meters in length (or shorter).

c. For test applied to unshielded symmetrically operated interconnection / telecommunication lines of EUT:

The surge is applied to the lines via gas arrestors coupling. Test levels below the ignition point of the coupling arrestor cannot be specified. The interconnection line between the EUT and the coupling/decoupling networks shall be 2 meters in length (or shorter).

5.8.4 DEVIATION FROM TEST STANDARD

No deviation.

5.8.5 TEST SETUP

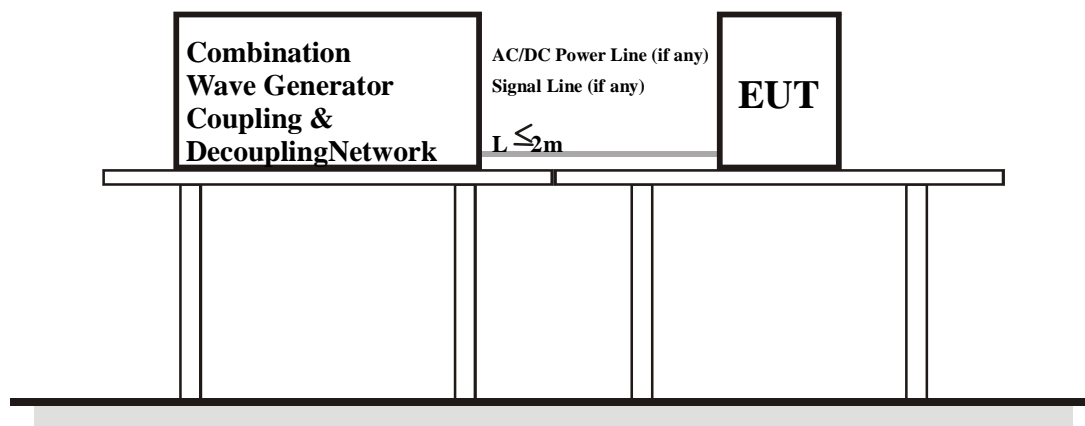

For the actual test configuration, please refer to the related item – Photographs of the Test Configuration.

5.8.6 TEST RESULTS

INPUT POWER	230 Vac, 50 Hz	ENVIRONMENTAL CONDITIONS	25 deg. C, 50% RH 1001 hPa
TESTED BY	Eason Chang		

AC/DC power port

Voltage (kV)	Test Point	Polarity	Observation				Performance Criterion
			0°	90°	180°	270°	
0.5, 1	L1-L2	+/-	NOTE	NOTE	NOTE	NOTE	A
0.5, 1, 2	L1-PE	+/-	NOTE	NOTE	NOTE	NOTE	A
0.5, 1, 2	L2-PE	+/-	NOTE	NOTE	NOTE	NOTE	A

NOTE: There was no change compared with initial operation during and after the test.

5.9 IMMUNITY TO CONDUCTED DISTURBANCES INDUCED BY RF FIELDS (CS)

5.9.1 TEST SPECIFICATION

Basic Standard:	IEC 61000-4-6
Frequency Range:	0.15 MHz ~ 80 MHz
Field Strength:	3 V _{r.m.s.}
Modulation:	1 kHz Sine Wave, 80%, AM Modulation
Frequency Step:	1 % of preceding frequency value
Coupled Cable:	Power Mains, Unshielded
Coupling Device:	CDN-M3 (3 wires), CDN-T8

5.9.2 TEST INSTRUMENTS

DESCRIPTION & MANUFACTURER	MODEL NO.	SERIAL NO.	DATE OF CALIBRATION	DUE DATE OF CALIBRATION
FCC POWER LINE COUPLING DECOUPLING NETWORK	M/N:FCC-801-M1-25A	03030	Nov. 04, 2008	Nov. 03, 2009
FCC POWER LINE COUPLING DECOUPLING NETWORK	M/N:FCC-801-M2-25A	03049	Nov. 04, 2008	Nov. 03, 2009
FCC POWER LINE COUPLING DECOUPLING NETWORK	M/N:FCC-801-M2-25A	03050	Nov. 04, 2008	Nov. 03, 2009
FCC POWER LINE COUPLING DECOUPLING NETWORK	M/N:FCC-801-M3-25A	03056	Nov. 04, 2008	Nov. 03, 2009
FCC POWER LINE COUPLING DECOUPLING NETWORK	M/N:FCC-801-M3-25A	03057	Nov. 04, 2008	Nov. 03, 2009
FCC SIGNAL LINE POWER LINE COUPLING DECOUPLING NETWORK	P/N:FCC-801-T2	03030	Nov. 04, 2008	Nov. 03, 2009
FCC SIGNAL LINE POWER LINE COUPLING DECOUPLING NETWORK	P/N:FCC-801-T4	03031	Nov. 04, 2008	Nov. 03, 2009
FCC SIGNAL LINE POWER LINE COUPLING DECOUPLING NETWORK	P/N:FCC-801-T8	03032	Nov. 04, 2008	Nov. 03, 2009
EMI Injection Clamp	P/N:F-203I-23MM	434	Nov. 04, 2008	Nov. 03, 2009
BOONTON 4232ARF POWER METER	4232A-01-02	104302	Nov. 03, 2008	Nov. 02, 2009
R&S Signal generator	SML 03	102843	Sep. 02, 2008	Dec. 23, 2010
Software	ADT_CS_V37	NA	NA	NA

- NOTE:** 1. The test was performed in Hwa Ya CS Room.
2. The calibration interval of the above test instruments is 12 months and the calibrations are traceable to NML/ROC and NIST/USA.

5.9.3 TEST PROCEDURE

- a. The EUT shall be tested within its intended operating and climatic conditions.
- b. The test shall be performed with the test generator connected to each of the coupling and decoupling devices in turn, while the other non-excited RF input ports of the coupling devices are terminated by a 50-ohm load resistor.
- c. The frequency range is swept from 150 kHz to 80 MHz, using the signal level established during the setting process and with a disturbance signal of 80 % amplitude. The signal is modulated with a 1 kHz sine wave, pausing to adjust the RF signal level or the switch coupling devices as necessary. Where the frequency is swept incrementally, the step size shall not exceed 1 % of the preceding frequency value.
- d. The dwell time of the amplitude modulated carrier at each frequency shall not be less than the time necessary for the EUT to be exercised and to respond, but shall in no case be less than 0.5 s. The sensitive frequencies (e.g. clock frequencies) shall be analyzed separately.
- e. Attempts should be made to fully exercise the EUT during testing, and to fully interrogate all exercise modes selected for susceptibility.

5.9.4 DEVIATION FROM TEST STANDARD

No deviation.

5.9.5 TEST SETUP

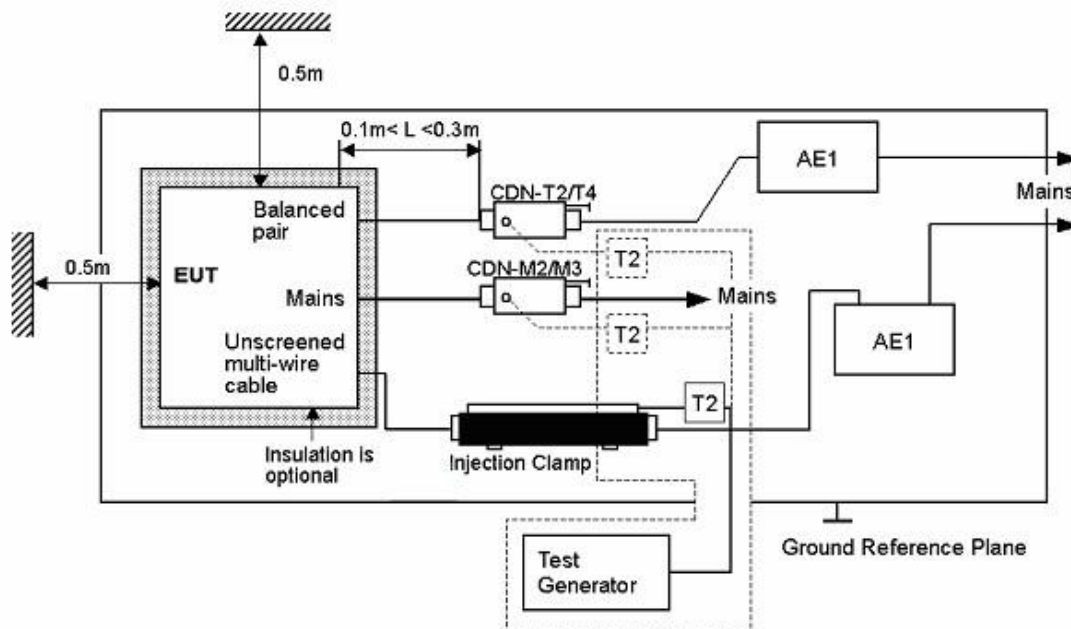

- Note:**
1. The EUT is setup 0.1 m above Ground Reference Plane
 2. The CDNs and / or EM clamp used for real test depends on ports and cables configuration of EUT.

For the actual test configuration, please refer to the related item – Photographs of the Test Configuration.

5.9.6 TEST RESULTS

INPUT POWER	230 Vac, 50 Hz	ENVIRONMENTAL CONDITIONS	25 deg. C, 52% RH 1008 hPa
TESTED BY	Jn Chen		

Frequency Band (MHz)	Applied Voltage (Vrms)	Tested Line	Injection Method	Observation	Performance Criterion
0.15-80	3	Power line	CDN-M3	NOTE	A
0.15-80	3	LAN	CDN-T8	NOTE	A

NOTE: There was no change compared with initial operation during and after the test.

5.10 POWER FREQUENCY MAGNETIC FIELD IMMUNITY TEST

5.10.1 TEST SPECIFICATION

Basic Standard:	IEC 61000-4-8
Frequency Range:	50 Hz
Field Strength:	1 A/m
Observation Time:	1 minute
Inductance Coil:	Rectangular type, 1mx1m

5.10.2 TEST INSTRUMENTS

DESCRIPTION & MANUFACTURER	MODEL NO.	SERIAL NO.	DATE OF CALIBRATION	DUE DATE OF CALIBRATION
Schaffner Induction Coil Interface	INA2141	6015	NA	NA
Schaffner AC Power Source	NSG1007	55616	Nov. 06, 2008	Nov. 05, 2009
Schaffner INA702 Coil	INA702	111	NA	NA
Software	Schaffner Win 2120V3	NA	NA	NA

- NOTE:** 1. The test was performed in Hwa Ya EMS Room.
 2. The calibration interval of the above test instruments is 12 months and the calibrations are traceable to NML/ROC and NIST/USA.

5.10.3 TEST PROCEDURE

- The equipment is configured and connected to satisfy its functional requirements.
- The power supply, input and output circuits shall be connected to the sources of power supply, control and signal.
- The cables supplied or recommended by the equipment manufacturer shall be used. 1 meter of all cables used shall be exposed to the magnetic field.

5.10.4 DEVIATION FROM TEST STANDARD

No deviation.

5.10.5 TEST SETUP

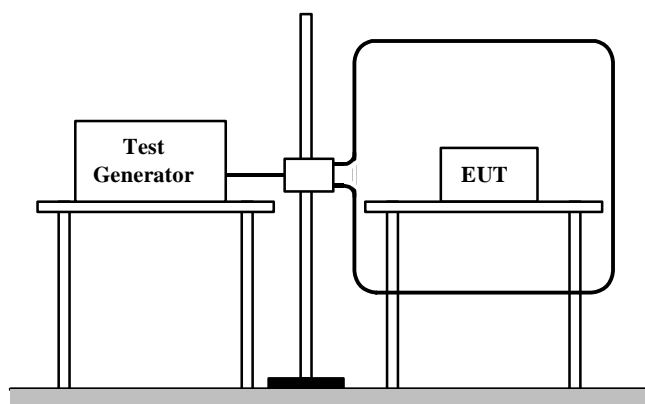

For the actual test configuration, please refer to the related item – Photographs of the Test Configuration.

NOTE:

TABLETOP EQUIPMENT

The equipment shall be subjected to the test magnetic field by using the induction coil of standard dimension (1 m x 1 m). The induction coil shall then be rotated by 90 degrees in order to expose the EUT to the test field with different orientations.

FLOOR-STANDING EQUIPMENT

The equipment shall be subjected to the test magnetic field by using induction coils of suitable dimensions. The test shall be repeated by moving and shifting the induction coils, in order to test the whole volume of the EUT for each orthogonal direction. The test shall be repeated with the coil shifted to different positions along the side of the EUT, in steps corresponding to 50 % of the shortest side of the coil. The induction coil shall then be rotated by 90 degrees in order to expose the EUT to the test field with different orientations.

5.10.6 TEST RESULTS

INPUT POWER	230 Vac, 50 Hz	ENVIRONMENTAL CONDITIONS	25 deg. C, 50% RH, 1008 hPa
TESTED BY	Jn Chen		

Direction	Field Strength (A/m)	Observation	Performance Criterion
X - Axis	1	NOTE	A
Y - Axis	1	NOTE	A
Z - Axis	1	NOTE	A

NOTE: There was no change compared with the initial operation during the test.

5.11 VOLTAGE DIP/SHORT INTERRUPTIONS/VOLTAGE VARIATIONS (DIP) IMMUNITY TEST

5.11.1 TEST SPECIFICATION

Basic Standard:	IEC 61000-4-11
Test Duration Time:	Minimum 3 test events in sequence
Interval between Event:	Minimum 10 seconds
Phase Angle:	0°/180°
Test Cycle:	3 times

5.11.2 TEST INSTRUMENTS

DESCRIPTION & MANUFACTURER	MODEL NO.	SERIAL NO.	DATE OF CALIBRATION	DUE DATE OF CALIBRATION
Schaffner AC Power Source	NSG1007	55616	Nov. 06, 2008	Nov. 05, 2009
Schaffner Signal Conditioning Unit- Lumped Impedance	CCN1000-1-LR1	72224	Nov. 06, 2008	Nov. 05, 2009
Software	Schaffner Win 2100V3	NA	NA	NA

- NOTE:** 1. The test was performed in Hwa Ya EMS Room.
2. The calibration interval of the above test instruments is 12 months and the calibrations are traceable to NML/ROC and NIST/USA.

5.11.3 TEST PROCEDURE

The EUT shall be tested for each selected combination of test levels and duration with a sequence of 3 dips/interruptions with intervals of 20 s minimum (between each test event). Each representative mode of operation shall be tested. Abrupt changes in supply voltage shall occur at zero crossings of the voltage waveform.

5.11.4 DEVIATION FROM TEST STANDARD

No deviation.

5.11.5 TEST SETUP

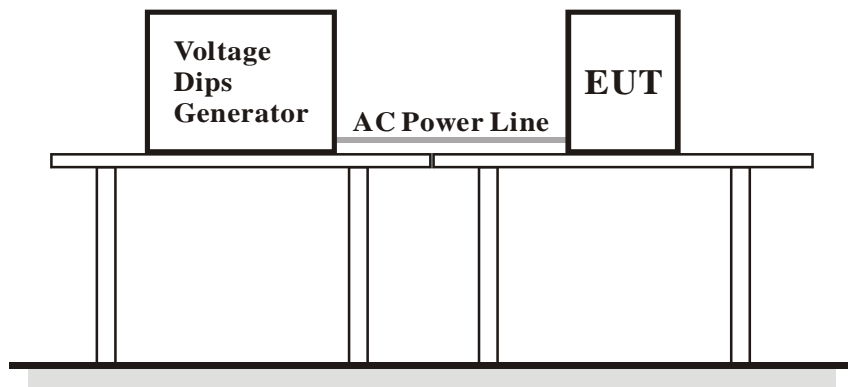

For the actual test configuration, please refer to the related item – Photographs of the Test Configuration.

5.11.6 TEST RESULTS

INPUT POWER	100-240 Vac, 50 Hz	ENVIRONMENTAL CONDITIONS	25 deg. C, 50% RH 1008 hPa
TESTED BY	Jn Chen		

Ut: 230Vac, 50Hz				
Voltage Dips (Reduction %)	Duration (Period)	Total Events (time)	Observation	Performance Criterion
>95	0.5	3	NOTE 1	A
30	25	3	NOTE 1	A
>95	250	3	NOTE 2	C

Ut: 240Vac, 50Hz				
Voltage Dips (Reduction %)	Duration (Period)	Total Events (time)	Observation	Performance Criterion
>95	0.5	3	NOTE 1	A
30	25	3	NOTE 1	A
>95	250	3	NOTE 2	C

Ut: 100Vac, 50Hz				
Voltage Dips (Reduction %)	Duration (Period)	Total Events (time)	Observation	Performance Criterion
>95	0.5	3	NOTE 1	A
30	25	3	NOTE 1	A
>95	250	3	NOTE 2	C

NOTE:

1. There was no change compared with the initial operation during the test.
2. The EUT shut down during the test, and must be recovered manually.

6 PHOTOGRAPHS OF THE TEST CONFIGURATION

Conducted Emission Test



Conducted Emission Test at Telecom Port



Radiated Emission Test (Frequency below 1GHz)

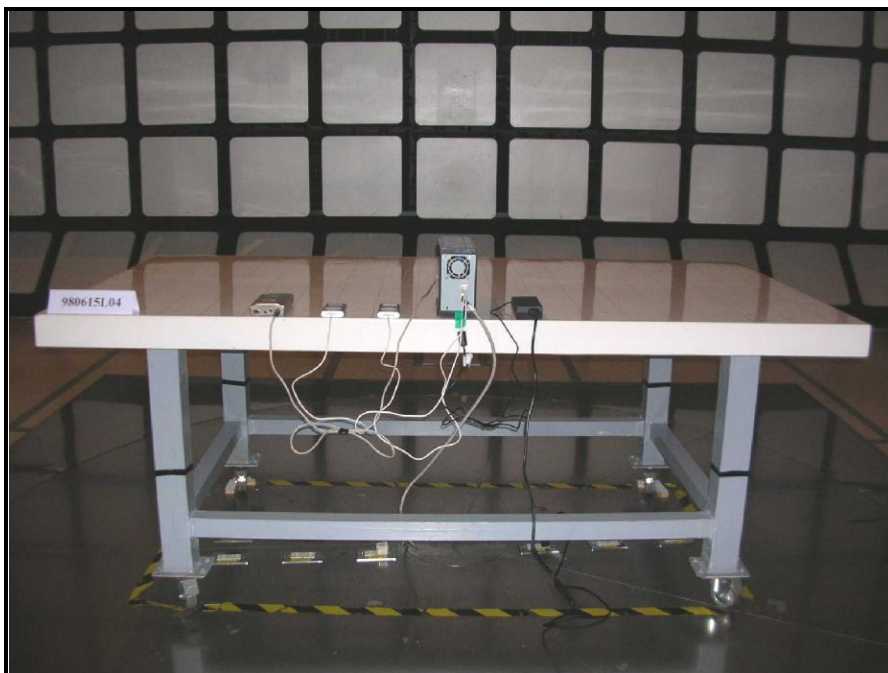

Radiated Emission Test (Frequency above 1GHz)



Harmonics Emission Test & Voltage Fluctuation and Flicker Test



ESD Test



RS Test

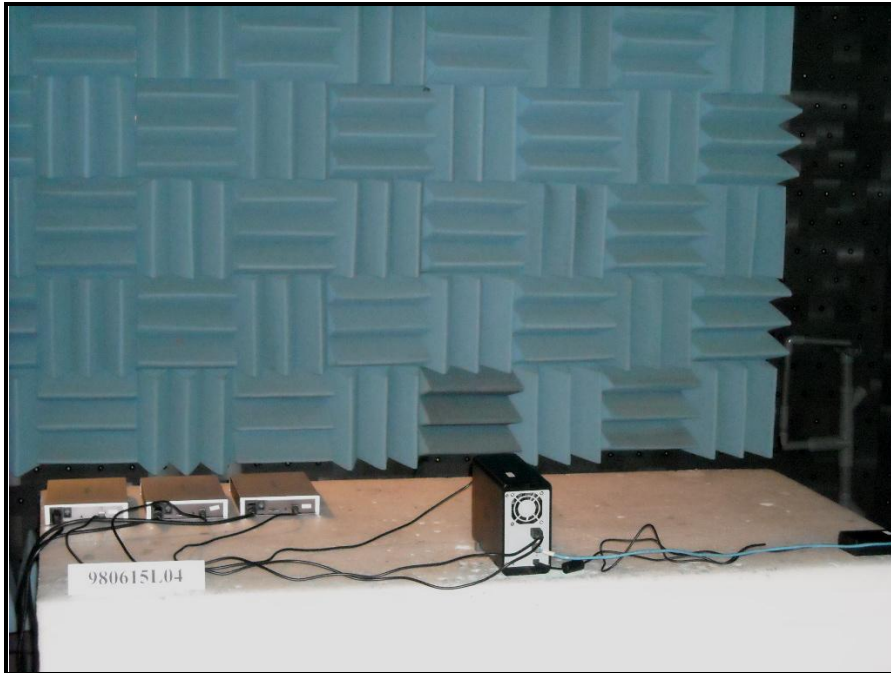

EFT Test



Surge Test

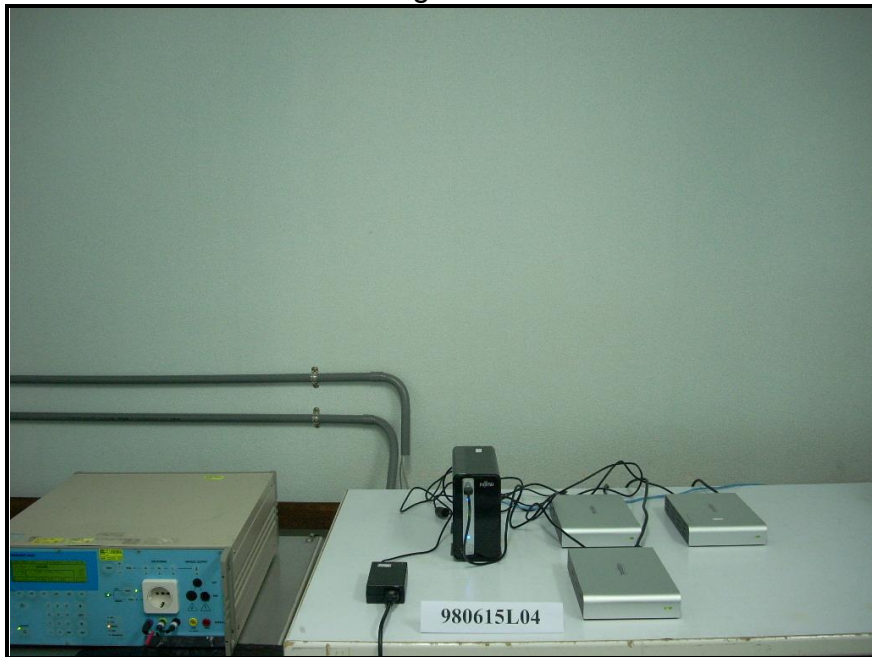

CS Test (Power line)

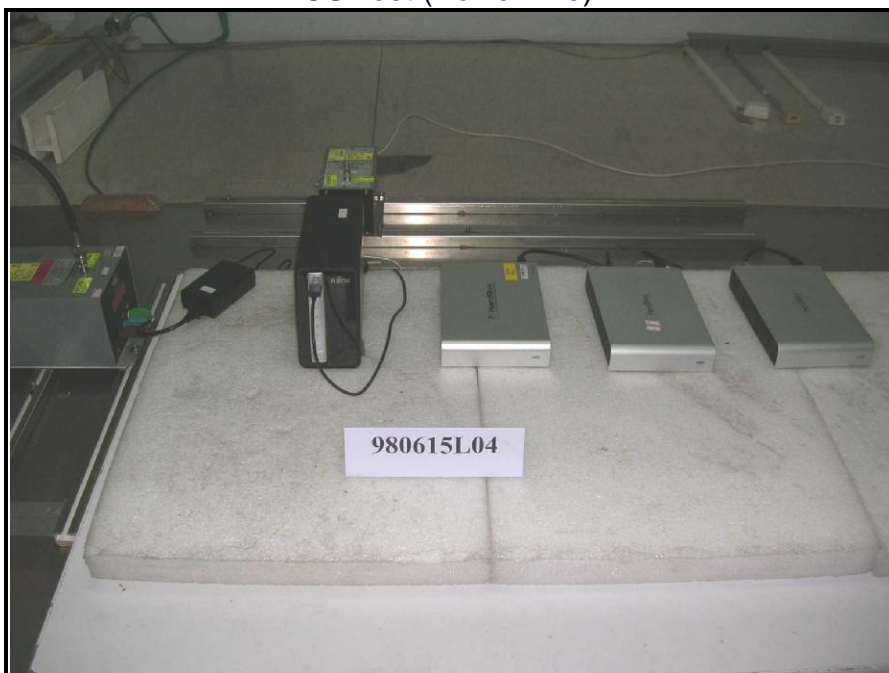

CS Test (LAN)



Magnetic Test



Voltage Dip and Interruption Test



7 PHOTOGRAPHS OF THE EQUIPMENT UNDER TEST





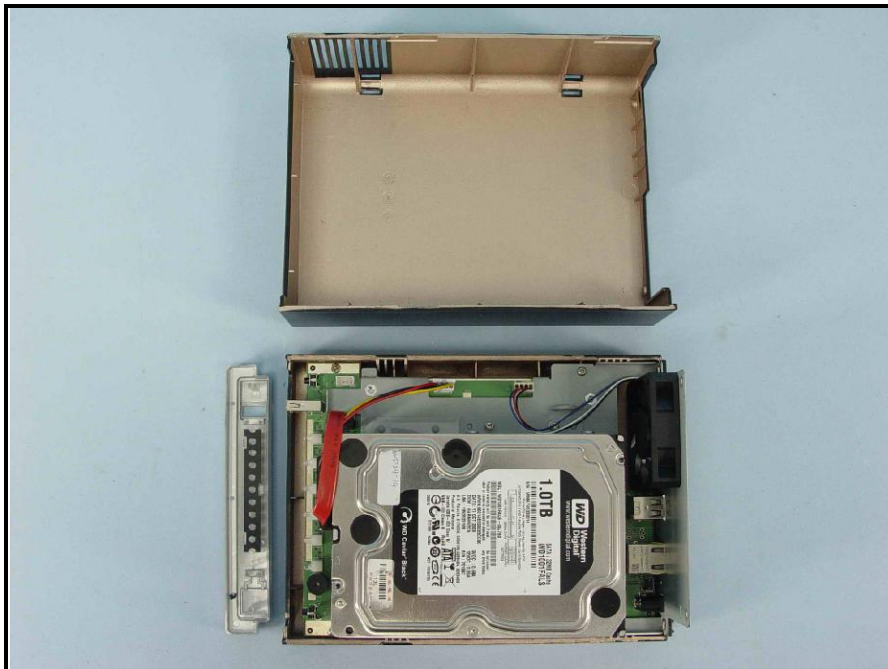



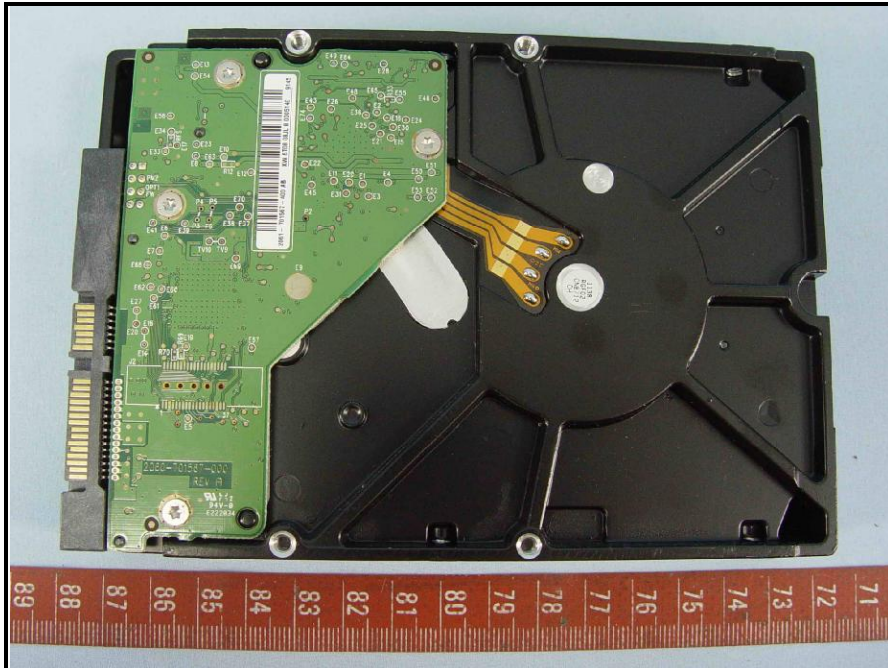

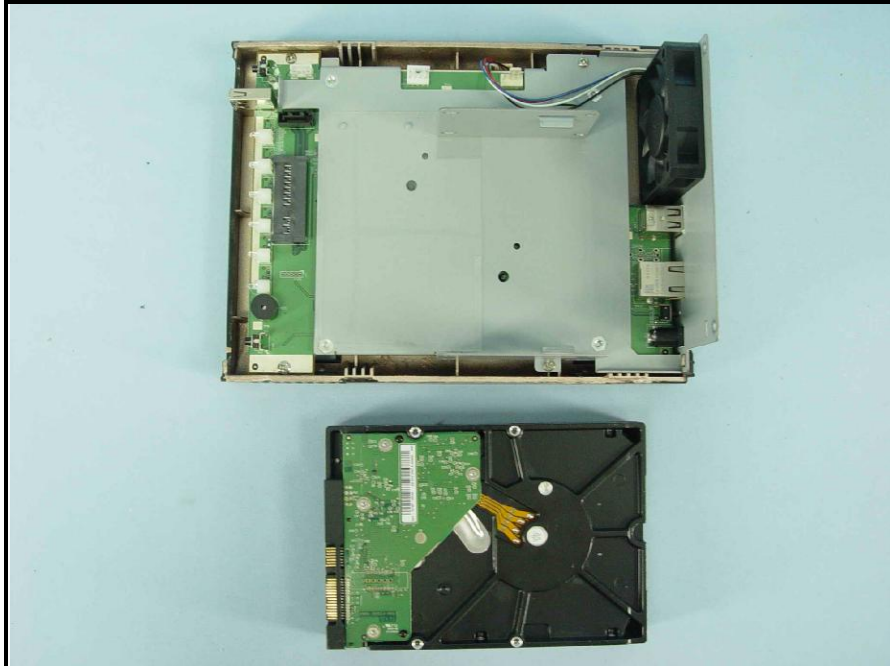

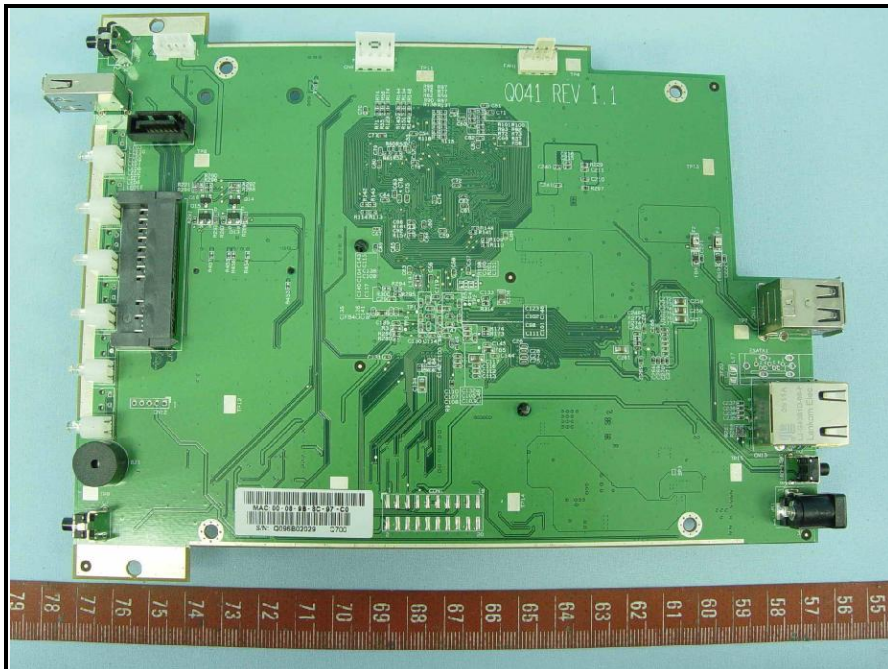
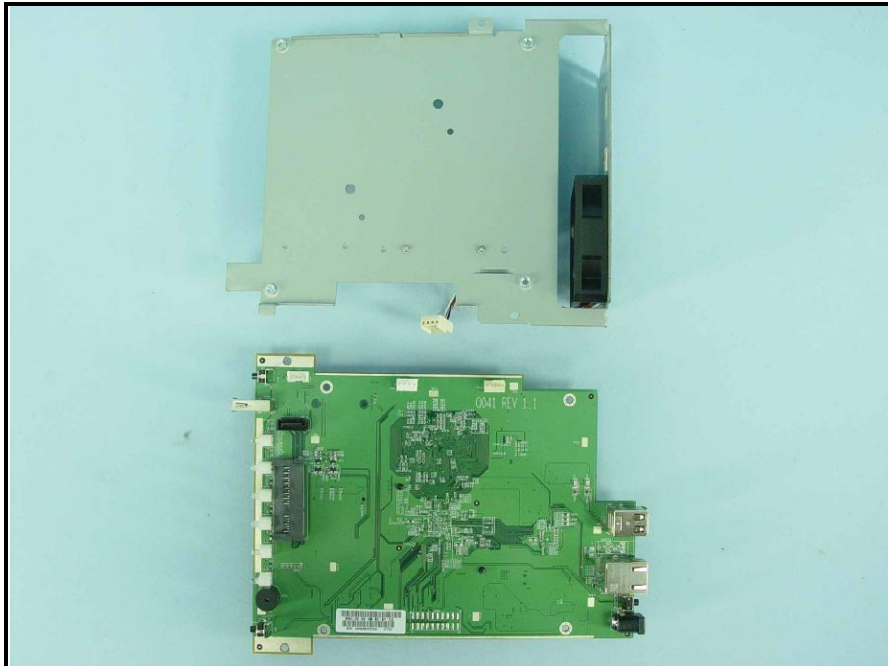

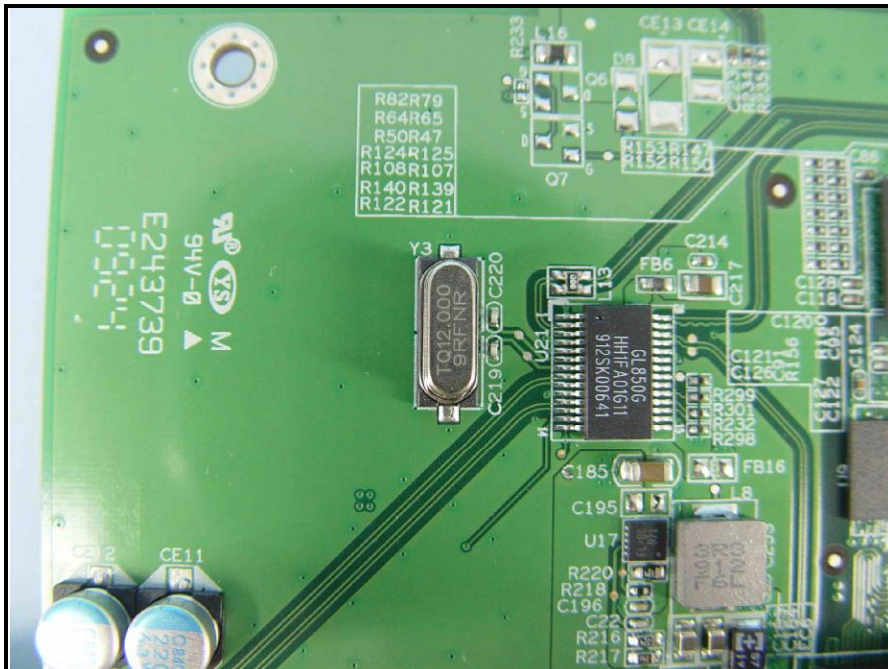
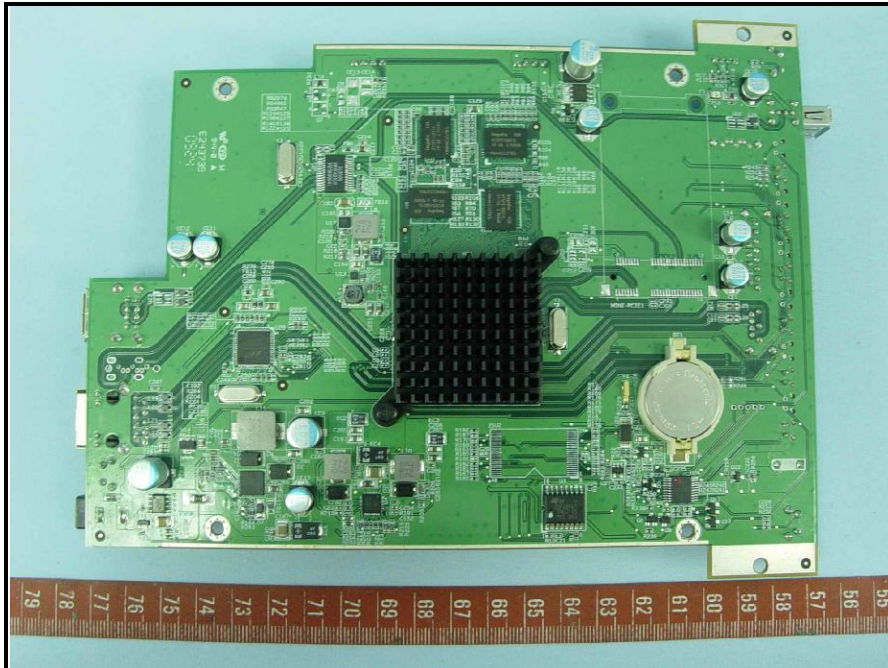





8 INFORMATION ON THE TESTING LABORATORIES

We, Bureau Veritas Consumer Products Services (H.K.) Ltd., Taoyuan Branch, were founded in 1988 to provide our best service in EMC, Radio, Telecom and Safety consultation. Our laboratories are accredited and approved according to ISO/IEC 17025.

Copies of accreditation certificates of our laboratories obtained from approval agencies can be downloaded from our web site: www.adt.com.tw/index.5/phtml. If you have any comments, please feel free to contact us at the following:

Linko EMC/RF Lab

Tel: 886-2-26052180

Fax: 886-2-26051924

Hsin Chu EMC/RF Lab

Tel: 886-3-5935343

Fax: 886-3-5935342

Hwa Ya EMC/RF/Safety/Telecom Lab

Tel: 886-3-3183232

Fax: 886-3-3185050

Email: service@adt.com.tw

Web Site: www.adt.com.tw

The address and road map of all our labs can be found in our web site also.

--- END ---