

Certificate

Issue Date: 7/4/2011
Ref. Report No. ISL-11HE173CE

Product Name : Network Attached Storage
Model(s) : TS-1279U-RP; TS-EC1279U-RP; TS-1279U-RP+; TS-EC1279U-RP+; TS-1279U II-RP; TS-EC1279U II-RP; NAS-1279UG-RP; NAS-EC1279UG-RP; NAS-1279UG-RP+; NAS-EC1279UG-RP+; NAS-1279UG II-RP; NAS-EC1279UG II-RP; NSS512R; VS-12064U-RP Pro; VS-12056U-RP Pro; VS-12048U-RP Pro; NVR-12064U-RP Pro; NVR-12056U-RP Pro; NVR-12048U-RP Pro; NVR-12064UG-RP Pro; NVR-12056UG-RP Pro; NVR-12048UG-RP Pro; VS-12000U-RP Pro; NVR-12000U-RP Pro; NVR-12000UG-RP Pro; VS-12080U-RP Pro; VS-12072U-RP Pro; VS-12040U-RP Pro; NVR-12080U-RP Pro; NVR-12072U-RP Pro; NVR-12040U-RP Pro; NVR-12080UG-RP Pro; NVR-12072UG-RP Pro; NVR-12040UG-RP Pro
Brand : QNAP
Responsible Party : QNAP Systems, Inc.
Address : 2F., No. 22, Zhongxing Rd., Xizhi Dist., New Taipei City 221, Taiwan (R. O. C.)

We, **International Standards Laboratory**, hereby certify that:

The device bearing the trade name and model specified above has been shown to comply with the applicable technical standards as indicated in the measurement report and was tested in accordance with the measurement procedures specified in European Council Directive- EMC Directive 2004/108/EC. The device was passed the test performed according to :



Standards:

EN 55022:2006 +A1:2007 / CISPR 22:2005 +A1:2005 / AS/NZS CISPR 22: 2009
EN 61000-3-2: 2006 and IEC 61000-3-2: 2005
EN 61000-3-3: 2008 and IEC 61000-3-3: 2008
EN55024:1998+A1:2001+A2:2003 / CISPR 24:1997+A1:2001+A2:2002
EN 61000-4-2: 2009 and IEC 61000-4-2: 2008
EN 61000-4-3: 2006 + A1:2008 and IEC 61000-4-3: 2006 +A1:2007
EN 61000-4-4: 2004 +A1:2010 and IEC 61000-4-4: 2004 +A1:2010
EN 61000-4-5: 2006 and IEC 61000-4-5: 2005
EN 61000-4-6: 2009 and IEC 61000-4-6: 2008
EN 61000-4-8: 1993+A1: 2001 and IEC 61000-4-8: 1993+A1: 2000
EN 61000-4-11: 2004 and IEC 61000-4-11: 2004

I attest to the accuracy of data and all measurements reported herein were performed by me or were made under my supervision and are correct to the best of my knowledge and belief. I assume full responsibility for the completeness of these measurements and vouch for the qualifications of all persons taking them.

International Standards Laboratory

Jim Chu / Director

Hsi-Chih LAB:

No. 65, Gu Dai Keng St., Hsichih District,
New Taipei City 22117, Taiwan
Tel: 886-2-2646-2550; Fax: 886-2-2646-4641



Lung-Tan LAB:

No. 120, Lane 180, San Ho Tsuen, Hsin Ho Rd.
Lung-Tan Hsiang, Tao Yuan County 325, Taiwan
Tel: 886-3-407-1718; Fax: 886-3407-1738



CE MARK TECHNICAL FILE

AS/NZS EMC CONSTRUCTION FILE

of

Product Name

Network Attached Storage

Model

**TS-1279U-RP; TS-EC1279U-RP; TS-1279U-RP+; TS-EC1279U-RP+; TS-1279U II-RP;
TS-EC1279U II-RP; NAS-1279UG-RP; NAS-EC1279UG-RP; NAS-1279UG-RP+;
NAS-EC1279UG-RP+; NAS-1279UG II-RP; NAS-EC1279UG II-RP; NSS512R;
VS-12064U-RP Pro; VS-12056U-RP Pro; VS-12048U-RP Pro; NVR-12064U-RP Pro;
NVR-12056U-RP Pro; NVR-12048U-RP Pro; NVR-12064UG-RP Pro;
NVR-12056UG-RP Pro; NVR-12048UG-RP Pro; VS-12000U-RP Pro; NVR-12000U-RP
Pro; NVR-12000UG-RP Pro; VS-12080U-RP Pro; VS-12072U-RP Pro; VS-12040U-RP
Pro; NVR-12080U-RP Pro; NVR-12072U-RP Pro; NVR-12040U-RP Pro;
NVR-12080UG-RP Pro; NVR-12072UG-RP Pro; NVR-12040UG-RP Pro**

Brand

QNAP

Contains:

1. Declaration of Conformity
2. EN55022/CISPR 22, AS/NZS CISPR 22 EMI test report
3. EN55024/CISPR 24, EN61000-3-2 / IEC 61000-3-2, and EN61000-3-3 / IEC 61000-3-3 test report
4. Certificate of EN60950-1
5. Block Diagram and Schematics
6. Users' manual

Declaration of Conformity

Name of Responsible Party: QNAP Systems, Inc.

Address of Responsible Party: 2F., No. 22, Zhongxing Rd., Xizhi Dist., New Taipei City 221, Taiwan (R. O. C.)

Declares that product: Network Attached Storage

Model: TS-1279U-RP; TS-EC1279U-RP; TS-1279U-RP+; TS-EC1279U-RP+; TS-1279U II-RP; TS-EC1279U II-RP; NAS-1279UG-RP; NAS-EC1279UG-RP; NAS-1279UG-RP+; NAS-EC1279UG-RP+; NAS-1279UG II-RP; NAS-EC1279UG II-RP; NSS512R; VS-12064U-RP Pro; VS-12056U-RP Pro; VS-12048U-RP Pro; NVR-12064U-RP Pro; NVR-12056U-RP Pro; NVR-12048U-RP Pro; NVR-12064UG-RP Pro; NVR-12056UG-RP Pro; NVR-12048UG-RP Pro; VS-12000U-RP Pro; NVR-12000U-RP Pro; NVR-12000UG-RP Pro; VS-12080U-RP Pro; VS-12072U-RP Pro; VS-12040U-RP Pro; NVR-12080U-RP Pro; NVR-12072U-RP Pro; NVR-12040U-RP Pro; NVR-12080UG-RP Pro; NVR-12072UG-RP Pro; NVR-12040UG-RP Pro

Brand: QNAP

Assembled by: Same as above

Address: Same as above

Conforms to the EMC Directive 2004/108/EC as attested by conformity with the following harmonized standards:

EN 55022:2006 +A1:2007 / CISPR 22:2005 +A1:2005 / AS/NZS CISPR 22: 2009: Limits and methods of measurement of Radio Interference characteristics of Information Technology Equipment.

EN55024:1998+A1:2001+A2:2003 / CISPR 24:1997+A1:2001+A2:2002: Information technology equipment-Immunity characteristics-Limits and methods of measurement.

Standard	Description	Results	Criteria
EN 61000-4-2:2009 IEC 61000-4-2:2008	Electrostatic Discharge	Pass	B
EN 61000-4-3:2006+A1:2008 IEC 61000-4-3:2006+A1:2007	Radio-Frequency, Electromagnetic Field	Pass	A
EN 61000-4-4: 2004 +A1:2010 IEC 61000-4-4: 2004 +A1:2010	Electrical Fast Transient/Burst	Pass	B
EN 61000-4-5: 2006 IEC 61000-4-5: 2005	Surge	Pass	B
EN 61000-4-6:2009 IEC 61000-4-6:2008	Conductive Disturbance	Pass	A
EN 61000-4-8: 1993+A1: 2001 IEC 61000-4-8: 1993+A1: 2000	Power Frequency Magnetic Field	Pass	A

<to be continued>

Standard	Description	Results	Criteria
EN 61000-4-11: 2004 IEC 61000-4-11: 2004	Voltage Dips / Short Interruption and Voltage Variation		
	>95% in 0.5 period	Pass	B
	30% in 25 period	Pass	C
	>95% in 250 period	Pass	C

Standard	Description	Results
EN 61000-3-2: 2006 IEC 61000-3-2: 2005	Limits for harmonics current emissions	Pass
EN 61000-3-3: 2008 IEC 61000-3-3: 2008	Limits for voltage fluctuations and flicker in low-voltage supply systems.	Pass

Conforms to the Low Voltage Directive 2006/95/EC, 93/68/EEC as attested by conformity with the following harmonized standard:

EN60950-1:2006+A11:2009: Safety of Information Technology Equipment Including electrical business equipment

We, QNAP Systems, Inc., hereby declare that the equipment bearing the trade name and model number specified above was tested conforming to the applicable Rules under the most accurate measurement standards possible, and that all the necessary steps have been taken and are in force to assure that production units of the same equipment will continue to comply with the requirements.

QNAP Systems, Inc.

Date: 7/4/2011

Declaration of Conformity

Name of Responsible Party: QNAP Systems, Inc.

Address of Responsible Party: 2F., No. 22, Zhongxing Rd., Xizhi Dist., New Taipei City 221, Taiwan (R. O. C.)

Declares that product: Network Attached Storage

Model: TS-1279U-RP; TS-EC1279U-RP; TS-1279U-RP+;
TS-EC1279U-RP+; TS-1279U II-RP; TS-EC1279U II-RP;
NAS-1279UG-RP; NAS-EC1279UG-RP;
NAS-1279UG-RP+; NAS-EC1279UG-RP+; NAS-1279UG
II-RP; NAS-EC1279UG II-RP; NSS512R; VS-12064U-RP
Pro; VS-12056U-RP Pro; VS-12048U-RP Pro;
NVR-12064U-RP Pro; NVR-12056U-RP Pro;
NVR-12048U-RP Pro; NVR-12064UG-RP Pro;
NVR-12056UG-RP Pro; NVR-12048UG-RP Pro;
VS-12000U-RP Pro; NVR-12000U-RP Pro;
NVR-12000UG-RP Pro; VS-12080U-RP Pro;
VS-12072U-RP Pro; VS-12040U-RP Pro; NVR-12080U-RP
Pro; NVR-12072U-RP Pro; NVR-12040U-RP Pro;
NVR-12080UG-RP Pro; NVR-12072UG-RP Pro;
NVR-12040UG-RP Pro

Brand: QNAP

Assembled by: Same as above
Address: Same as above

Conforms to the C-Tick Mark requirement as attested by conformity with the following standards:

EN 55022:2006 +A1:2007 / CISPR 22:2005 +A1:2005 / AS/NZS CISPR 22: 2009: Limits and methods of measurement of Radio Interference characteristics of Information Technology Equipment.

EN55024:1998+A1:2001+A2:2003 / CISPR 24:1997+A1:2001+A2:2002: Information technology equipment-Immunity characteristics-Limits and methods of measurement.

Standard	Description	Results	Criteria
EN 61000-4-2:2009 IEC 61000-4-2:2008	Electrostatic Discharge	Pass	B
EN 61000-4-3:2006+A1:2008 IEC 61000-4-3:2006+A1:2007	Radio-Frequency, Electromagnetic Field	Pass	A
EN 61000-4-4: 2004 +A1:2010 IEC 61000-4-4: 2004 +A1:2010	Electrical Fast Transient/Burst	Pass	B
EN 61000-4-5: 2006 IEC 61000-4-5: 2005	Surge	Pass	B
EN 61000-4-6:2009 IEC 61000-4-6:2008	Conductive Disturbance	Pass	A
EN 61000-4-8: 1993+A1: 2001 IEC 61000-4-8: 1993+A1: 2000	Power Frequency Magnetic Field	Pass	A

<to be continued>

Standard	Description	Results	Criteria
EN 61000-4-11: 2004 IEC 61000-4-11: 2004	Voltage Dips / Short Interruption and Voltage Variation		
	>95% in 0.5 period	Pass	B
	30% in 25 period	Pass	C
	>95% in 250 period	Pass	C

Standard	Description	Results
EN 61000-3-2: 2006 IEC 61000-3-2: 2005	Limits for harmonics current emissions	Pass
EN 61000-3-3: 2008 IEC 61000-3-3: 2008	Limits for voltage fluctuations and flicker in low-voltage supply systems.	Pass

We, QNAP Systems, Inc., hereby declare that the equipment bearing the trade name and model number specified above was tested conforming to the applicable Rules under the most accurate measurement standards possible, and that all the necessary steps have been taken and are in force to assure that production units of the same equipment will continue to comply with the requirements.

QNAP Systems, Inc.

Date: 7/4/2011

CE TEST REPORT

of
EN55022 / CISPR 22 / AS/NZS CISPR 22
Class B
EN55024 / CISPR 24 / IMMUNITY
EN61000-3-2 / EN61000-3-3

Product : **Network Attached Storage**

Model(s): TS-1279U-RP; TS-EC1279U-RP; TS-1279U-RP+; TS-EC1279U-RP+; TS-1279U II-RP; TS-EC1279U II-RP; NAS-1279UG-RP; NAS-EC1279UG-RP; NAS-1279UG-RP+; NAS-EC1279UG-RP+; NAS-1279UG II-RP; NAS-EC1279UG II-RP; NSS512R; VS-12064U-RP Pro; VS-12056U-RP Pro; VS-12048U-RP Pro; NVR-12064U-RP Pro; NVR-12056U-RP Pro; NVR-12048U-RP Pro; NVR-12064UG-RP Pro; NVR-12056UG-RP Pro; NVR-12048UG-RP Pro; VS-12000U-RP Pro; NVR-12000U-RP Pro; NVR-12000UG-RP Pro; VS-12080U-RP Pro; VS-12072U-RP Pro; VS-12040U-RP Pro; NVR-12080U-RP Pro; NVR-12072U-RP Pro; NVR-12040U-RP Pro; NVR-12080UG-RP Pro; NVR-12072UG-RP Pro; NVR-12040UG-RP Pro

Brand: **QNAP**

Applicant: **QNAP Systems, Inc.**

Address: **2F., No. 22, Zhongxing Rd., Xizhi Dist., New Taipei City 221, Taiwan (R. O. C.)**

Test Performed by:

International Standards Laboratory

<Hsi-Chih LAB>

*Site Registration No.

BSMI:SL2-IN-E-0037; SL2-R1/R2-E-0037; TAF: 1178;

IC: IC4067A-1; VCCI: R-341,C-354, T-1749; NEMKO: ELA 113A

*Address:

No. 65, Gu Dai Keng St.

Hsi_Chih District, New Taipei City 22117, Taiwan

*Tel: 886-2-2646-2550; Fax: 886-2-2646-4641

Report No.: **ISL-11HE173CE**

Issue Date : **7/4/2011**

This report totally contains 53 pages including this cover page and contents page.

Test results given in this report apply only to the specific sample(s) tested and are traceable to national or international standard through calibration of the equipment and evaluating measurement uncertainty herein.

This report MUST not be used to claim product endorsement by TAF, NEMKO or any agency of the Government.

This test report shall not be reproduced except in full, without the written approval of International Standards Laboratory.

Contents of Report

1.	General.....	1
1.1	Certification of Accuracy of Test Data	1
1.2	Test Standards	2
1.3	Description of EUT	3
1.4	Description of Support Equipment	6
1.5	Software for Controlling Support Unit.....	7
1.6	I/O Cable Condition of EUT and Support Units	8
2.	Power Main Port Conducted Emissions	9
2.1	Test Setup and Procedure	9
2.1.1	Test Setup	9
2.1.2	Test Procedure	9
2.1.3	EMI Receiver/Spectrum Analyzer Configuration (for the frequencies tested).....	9
2.2	Conduction Test Data: Configuration 1	10
3.	Telecommunication Port Conducted Emissions	12
3.1	Test Setup and Procedure	12
3.1.1	Test Setup	12
3.1.2	Test Procedure	12
3.1.3	EMI Receiver/Spectrum Analyzer Configuration (for the frequencies tested).....	12
3.2	Test Data: LAN--10M: Configuration 1.....	13
3.3	Test Data: LAN--100M: Configuration 1.....	14
3.4	Test Data: LAN--GIGA: Configuration 1	15
3.5	Test Data: LAN--10M: Configuration 2.....	16
3.6	Test Data: LAN--100M: Configuration 2.....	17
3.7	Test Data: LAN--GIGA: Configuration 2	18
4.	Radiated Disturbance Emissions	19
4.1	Test Setup and Procedure	19
4.1.1	Test Setup	19
4.1.2	Test Procedure	19
4.1.3	Spectrum Analyzer Configuration (for the frequencies tested)	20
4.2	Radiation Test Data: Configuration 1.....	21
5.	Electrostatic discharge (ESD) immunity	25
5.1	Electrostatic discharge (ESD) immunity test	25
6.	Radio-Frequency, Electromagnetic Field immunity.....	26
6.1	Radio-Frequency, Electromagnetic Field immunity test.....	26
7.	Electrical Fast transients/burst immunity	27
7.1	Electrical Fast transient/burst immunity test.....	27
8.	Surge Immunity	29
8.1	Surge immunity test.....	29
9.	Immunity to Conductive Disturbance.....	30
9.1	Immunity to Conductive Disturbance	30
10.	Power Frequency Magnetic Field immunity	31
10.1	Power Frequency Magnetic field immunity test	31
11.	Voltage Dips, Short Interruption and Voltage Variation immunity	32
11.1	Voltage Dips, Short Interruption and Voltage Variation immunity test	32
12.	Harmonics	33
12.1	Harmonics test.....	33
13.	Voltage Fluctuations	36
13.1	Voltage Fluctuations test.....	36
14.	Appendix.....	38

14.1	Appendix A: Test Equipment.....	38
14.1.1	Test Equipment List.....	38
14.1.2	Software for Controlling Spectrum/Receiver and Calculating Test Data.....	41
14.2	Appendix B: Uncertainty of Measurement	42
14.3	Appendix C: Photographs of EUT Configuration Test Set Up.....	43
14.3.1	Photo of Main Power Port Conducted Emission and Telecommunication Port Conducted Emission Measurement	43
14.3.2	Photo of Radiated Emission Measurement	錯誤! 尙未定義書籤。
14.3.3	Photo of ESD Measurement	錯誤! 尙未定義書籤。
14.3.4	Photo of RF Field Strength Susceptibility Measurement.....	錯誤! 尙未定義書籤。
14.3.5	Photo of Electrical Fast Transient/Burst Measurement	錯誤! 尙未定義書籤。
14.3.6	Photo of Surge Measurement.....	錯誤! 尙未定義書籤。
14.3.7	Photo of Conductive Measurement.....	錯誤! 尙未定義書籤。
14.3.8	Photo of Magnetic field Measurement.....	錯誤! 尙未定義書籤。
14.3.9	Photo of Voltage Dips Measurement.....	錯誤! 尙未定義書籤。
14.3.10	Photo of Harmonics and Voltage Fluctuations	錯誤! 尙未定義書籤。
14.4	Appendix D: Photographs of EUT Please refer to the File of ISL-11HE173P.....	50

1. General

1.1 Certification of Accuracy of Test Data

Standards: Please refer to 1.2

Equipment Tested: Network Attached Storage

Model: TS-1279U-RP; TS-EC1279U-RP; TS-1279U-RP+;
TS-EC1279U-RP+; TS-1279U II-RP; TS-EC1279U II-RP;
NAS-1279UG-RP; NAS-EC1279UG-RP; NAS-1279UG-RP+;
NAS-EC1279UG-RP+; NAS-1279UG II-RP; NAS-EC1279UG
II-RP; NSS512R; VS-12064U-RP Pro; VS-12056U-RP Pro;
VS-12048U-RP Pro; NVR-12064U-RP Pro; NVR-12056U-RP Pro;
NVR-12048U-RP Pro; NVR-12064UG-RP Pro; NVR-12056UG-RP
Pro; NVR-12048UG-RP Pro; VS-12000U-RP Pro; NVR-12000U-RP
Pro; NVR-12000UG-RP Pro; VS-12080U-RP Pro; VS-12072U-RP
Pro; VS-12040U-RP Pro; NVR-12080U-RP Pro; NVR-12072U-RP
Pro; NVR-12040U-RP Pro; NVR-12080UG-RP Pro;
NVR-12072UG-RP Pro; NVR-12040UG-RP Pro

Brand: QNAP

Applicant: QNAP Systems, Inc.

Sample received Date: 5/12/2011

Final test Date: EMI:refer to the date of test data
EMS: 2011-05-23

Test Site: International Standards Laboratory
OATS 01; Chamber 14; Conduction 01; Immunity01

Test Distance: 10M; 3M (above1GHz) (EMI test)

Temperature: refer to each site test data

Humidity: refer to each site test data

Input power: Conduction input power: AC 230 V / 50 Hz
Radiation input power: AC 230 V / 50 Hz
Immunity input power: AC 230 V / 50 Hz

Test Result: PASS

Report Engineer: Winnie Huang

Test Engineer: 
Louis Yu

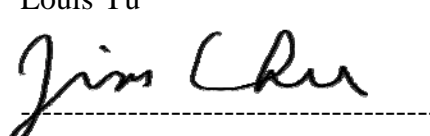
Approved By: 
Jim Chu / Director

1.2 Test Standards

The tests which this report describes were conducted by an independent electromagnetic compatibility consultant, International Standards Laboratory in accordance with the following

EN 55022:2006 +A1:2007 / CISPR 22:2005 +A1:2005 / AS/NZS CISPR 22: 2009: Class B: Limits and methods of measurement of Radio Interference characteristics of Information Technology Equipment.

EN55024:1998+A1:2001+A2:2003 / CISPR 24:1997+A1:2001+A2:2002: Information technology equipment-Immunity characteristics-Limits and methods of measurement.

Standard	Description	Results	Criteria
EN 61000-4-2:2009 IEC 61000-4-2:2008	Electrostatic Discharge	Pass	B
EN 61000-4-3:2006+A1:2008 IEC 61000-4-3:2006+A1:2007	Radio-Frequency, Electromagnetic Field	Pass	A
EN 61000-4-4: 2004 +A1:2010 IEC 61000-4-4: 2004 +A1:2010	Electrical Fast Transient/Burst	Pass	B
EN 61000-4-5: 2006 IEC 61000-4-5: 2005	Surge	Pass	B
EN 61000-4-6:2009 IEC 61000-4-6:2008	Conductive Disturbance	Pass	A
EN 61000-4-8: 1993+A1: 2001 IEC 61000-4-8: 1993+A1: 2000	Power Frequency Magnetic Field	Pass	A
EN 61000-4-11: 2004 IEC 61000-4-11: 2004	Voltage Dips / Short Interruption and Voltage Variation		
	>95% in 0.5 period	Pass	B
	30% in 25 period	Pass	C
	>95% in 250 period	Pass	C

Standard	Description	Results
EN 61000-3-2: 2006 IEC 61000-3-2: 2005	Limits for harmonics current emissions	Pass
EN 61000-3-3: 2008 IEC 61000-3-3: 2008	Limits for voltage fluctuations and flicker in low-voltage supply systems.	Pass

1.3 Description of EUT

EUT

Description:	Network Attached Storage
Condition:	Pre-Production
Model:	TS-1279U-RP; TS-EC1279U-RP; TS-1279U-RP+; TS-EC1279U-RP+; TS-1279U II-RP; TS-EC1279U II-RP; NAS-1279UG-RP; NAS-EC1279UG-RP; NAS-1279UG-RP+; NAS-EC1279UG-RP+; NAS-1279UG II-RP; NAS-EC1279UG II-RP; NSS512R; VS-12064U-RP Pro; VS-12056U-RP Pro; VS-12048U-RP Pro; NVR-12064U-RP Pro; NVR-12056U-RP Pro; NVR-12048U-RP Pro; NVR-12064UG-RP Pro; NVR-12056UG-RP Pro; NVR-12048UG-RP Pro; VS-12000U-RP Pro; NVR-12000U-RP Pro; NVR-12000UG-RP Pro; VS-12080U-RP Pro; VS-12072U-RP Pro; VS-12040U-RP Pro; NVR-12080U-RP Pro; NVR-12072U-RP Pro; NVR-12040U-RP Pro; NVR-12080UG-RP Pro; NVR-12072UG-RP Pro; NVR-12040UG-RP Pro
Serial Number:	N/A
Power Supply Type:	two DELTA (Model: DPS-600SB D) AC Input: 100-240V~/ 10A DC Output: +12V 49A +5V 3A Total output wattage: 600W MAX.
CPU:	Intel® Core™ i3 2120 3.3GHz
DIMM Memory:	ADATA (Model: HY03I1B18C1ZM) 2GB DDR3-1333MHz
Power Switch Button:	one
USB 2.0 Port:	four (4-pins)
USB 3.0 Port:	two (9-pins)
E-Serial ATA Port:	two (7-pins)
RJ45 Connector:	two (8-pins) (10/100/1000Mbps)
Hard Disk:	twelve
Highest frequency of the internal sources of the EUT is 3.3GHz	

All types of EUT Connect have been tested. The worst data listed in this test report.

Test Configuration:

EUT + twelve Hard Disk + External HDD (A-TEC Model: OT-201)*4 + Drive Station USB3.0 Hard Drive(BUFFALO Model: BUF-HD-HXU3(B))*2 + E-SATA External HDD (NexStar Model: NST-200SU-BK)*2 + Power Supply (DELTA Model: DPS-600SB D)*2 + LCD Monitor (View Sonic Model: VA703B) + LAN (1000Mbps)*2

EMI Noise Source

Crystal:25MHz (Y1), 25MHz (Y2), 24MHz (Y3), 25MHz (Y6), 25MHz (Y7),
25MHz (Y8), 32.768KHz (X1), 25MHz (X2), 12MHz (Y1), 25MHz (U20),

EMI Solution:

1. Added two Copper foil tapes on the RJ-45 Connector contact housing.
(Reference EUT photo 33)

Model Different

Model	Package	Selling markets
TS-1279U-RP	QNAP Brown Box	Commercial storage related products supply chain management
TS-EC1279U-RP	QNAP Brown Box	Commercial storage related products supply chain management
TS-1279U-RP+	QNAP Brown Box	Industrial storage related products supply chain management
TS-EC1279U-RP+	QNAP Brown Box	Industrial storage related products supply chain management
TS-1279U II-RP	QNAP Brown Box	Professional/Industrial storage related products supply chain management
TS-EC1279U II-RP	QNAP Brown Box	Professional/Industrial storage related products supply chain management
NAS-1279UG-RP	Brown Box (No QNAP Logo)	Commercial Storage equipment Tender and Cooperation plan
NAS-EC1279UG-RP	Brown Box (No QNAP Logo)	Commercial Storage equipment Tender and Cooperation plan
NAS-1279UG-RP+	Brown Box (No QNAP Logo)	Industrial Storage equipment Tender and Cooperation plan
NAS-EC1279UG-RP+	Brown Box (No QNAP Logo)	Industrial Storage equipment Tender and Cooperation plan
NAS-1279UG II-RP	Brown Box (No QNAP Logo)	Professional/Industrial Storage equipment Tender and Cooperation plan
NAS-EC1279UG II-RP	Brown Box (No QNAP Logo)	Professional/Industrial Storage equipment Tender and Cooperation plan
NSS512R	Cisco Brown Box (Cisco Logo)	Professional/Industrial Storage equipment Tender and Cooperation plan
VS-12064U-RP Pro	Carton Box	Large video storage related products supply chain management
VS-12056U-RP Pro	Carton Box	Industrial Monitor storage related products supply chain management
VS-12048U-RP Pro	Carton Box	Professional Monitor storage related products supply chain management
NVR-12064U-RP Pro	Carton Box	Large Monitor storage Tender product
NVR-12056U-RP Pro	Carton Box	Industrial Monitor storage Tender product
NVR-12048U-RP Pro	Carton Box	Professional Monitor storage Tender product
NVR-12064UG-RP Pro	Carton Box (No QNAP Logo)	Large video Image storage Cooperation plan
NVR-12056UG-RP Pro	Carton Box (No QNAP Logo)	Industrial Image storage Cooperation plan
NVR-12048UG-RP Pro	Carton Box (No QNAP Logo)	Professional Image storage Cooperation plan
VS-12000U-RP Pro	Carton Box	General Professional Monitor storage related products supply chain management
NVR-12000U-RP Pro	Carton Box	General Professional Monitor storage Tender product
NVR-12000UG-RP Pro	Carton Box (No QNAP Logo)	General Professional Image storage Cooperation plan
VS-12080U-RP Pro	Carton Box	Large video storage related products supply chain management
VS-12072U-RP Pro	Carton Box	Industrial Monitor storage related products supply chain management
VS-12040U-RP Pro	Carton Box	Professional Monitor storage related products supply chain management
NVR-12080U-RP Pro	Carton Box	Large Monitor storage Tender product
NVR-12072U-RP Pro	Carton Box	Industrial Monitor storage Tender product
NVR-12040U-RP Pro	Carton Box	Professional Monitor storage Tender product
NVR-12080UG-RP Pro	Carton Box (No QNAP Logo)	Large video Image storage Cooperation plan
NVR-12072UG-RP Pro	Carton Box (No QNAP Logo)	Industrial Image storage Cooperation plan
NVR-12040UG-RP Pro	Carton Box (No QNAP Logo)	Professional Image storage Cooperation plan

1.4 Description of Support Equipment

Unit	Model Serial No.	Brand	Power Cord	FCC ID
Notebook Personal Computer	Latitude D400 S/N: N/A	DELL	Non-shielded, Detachable	FCC DOC
17" LCD Monitor	VA703B	View Sonic	Non-shielded, Detachable	FCC DOC
External HDD Enclosure*4	OT-201 S/N: N/A	A-TEC	N/A	FCC DOC
Drive Station USB3.0 Hard Drive*2	BUF-HD-HXU3(B) S/N:15564800202599	BUFFALO	Non-shielded, Detachable	FCC DOC
E-SATA External Hard Disk*2	NST-200SU-BK S/N: N/A	NexStar	Non-shielded, Detachable	FCC DOC
Rack mountable Switch	DGS-1008D	D-Link	D-Link (Model:AF-1205-B)	FCC DOC

1.5 Software for Controlling Support Unit

Test programs exercising various part of EUT were used. The programs were executed as follows:

- A. Send EUT information to the video port device (Monitor).
- B. Receive and transmit package of EUT to the Rack mountable Switch HUB through LAN port.
- C. Read and write data in the E-SATA Hard Disk through EUT E-SATA port.
- D. R/W External HDD Enclosure from USB Port.
- E. Used Tfggen.exe to send signal to EUT RJ45 port through PC RJ45 Port.
- F. Search External HDD from Notebook RJ45 to EUT RJ45 with InterEMC.exe.
- G. Repeat the above steps.

	Filename	Issued Date
External Hard Disk	InterEMC.exe	04/16/2003
E-SATA	Intel EMC.exe	04/16/2003
Rack mountable Switch	ping.exe	05/05/1999
EUT Hard Disk	InterEMC.exe	04/16/2003
RJ45	Tfggen.exe	05/22/2001

1.6 I/O Cable Condition of EUT and Support Units

Description	Path	Cable Length	Cable Type	Connector Type
AC Power Cord	110V (~240V) to EUT SPS	1.8M	Non-shielded, Detachable	Plastic Head
USB Data Cable*4	External HDD Enclosure USB Port to EUT USB Port	0.98M	Non-shielded, Detachable (With Core)	Metal Head
USB 3.0 Data Cable*2	Drive Station USB3.0 Hard Drive USB port to EUT USB 3.0 port	1.0M	shielded, Detachable	Metal Head
E-SATA Data Cable*2	External Hard disk E-SATA Port to EUT E-SATA Port	1.0M	Non-Shielded, Detachable	Metal Head
LAN Data Cable	NB LAN Port to Switch HUB LAN Port.	33 feet	Non-shielded, Detachable	Plastic Head
LAN Data Cable*2	EUT LAN Port to Switch HUB LAN Port	10M	Non-shielded, Detachable	Plastic Head
LCD Monitor Data Cable	LCD Monitor D-Sub Port to EUT D-Sub Port	1.98M	Non-Shielded, Detachable	Metal Head

2. Power Main Port Conducted Emissions

2.1 Test Setup and Procedure

2.1.1 Test Setup

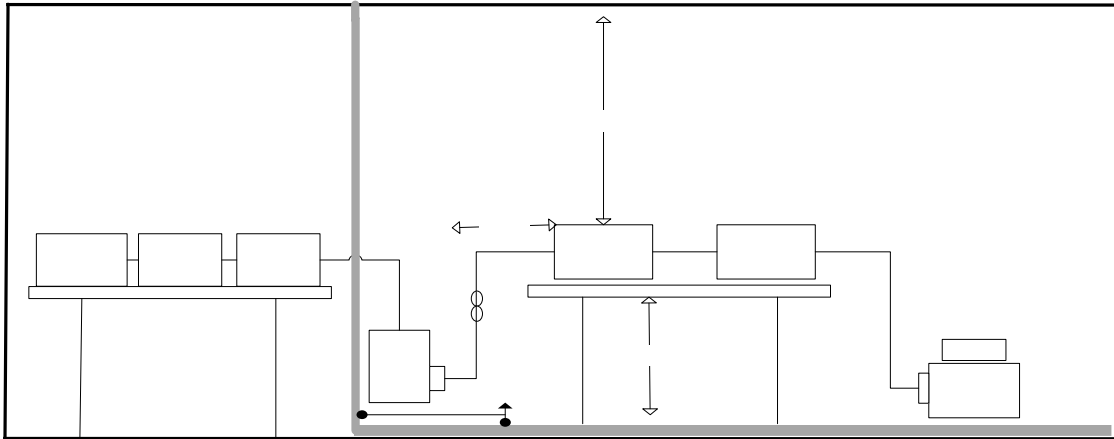

2.1.2 Test Procedure

The measurements are performed in a 3.5m x 3.4m x 2.5m shielded room, which referred as Conduction 01 test site, or a 3m x 3m x 2.3m test site, which referred as Conduction 02 test site. The EUT was placed on non-conduction 1.0m x 1.5m table, which is 0.8 meters above an earth-grounded.

Power to the EUT was provided through the LISN which has the Impedance (50ohm/50uH) vs. Frequency Characteristic in accordance with the standard. Power to the LISNs were filtered to eliminate ambient signal interference and these filters were bonded to the ground plane. Peripheral equipment required to provide a functional system (support equipment) for EUT testing was powered from the second LISN through a ganged, metal power outlet box which is bonded to the ground plane at the LISN. Printer Control Receiver PC

The interconnecting cables were arranged and moved to get the maximum measurement. Both the line of power cord, hot and neutral, were measured.

The highest emissions were analyzed in details by operating the spectrum analyzer in fixed tuned mode to determine the nature of the emissions and to provide information which could be useful in reducing their amplitude.

2.1.3 EMI Receiver/Spectrum Analyzer Configuration (for the frequencies tested)

Frequency Range:	150KHz--30MHz
Detector Function:	Quasi-Peak / Average Mode
Resolution Bandwidth:	9KHz

2.2 Conduction Test Data: Configuration 1

Table 2.2.1 Power Line Conducted Emissions (Hot)

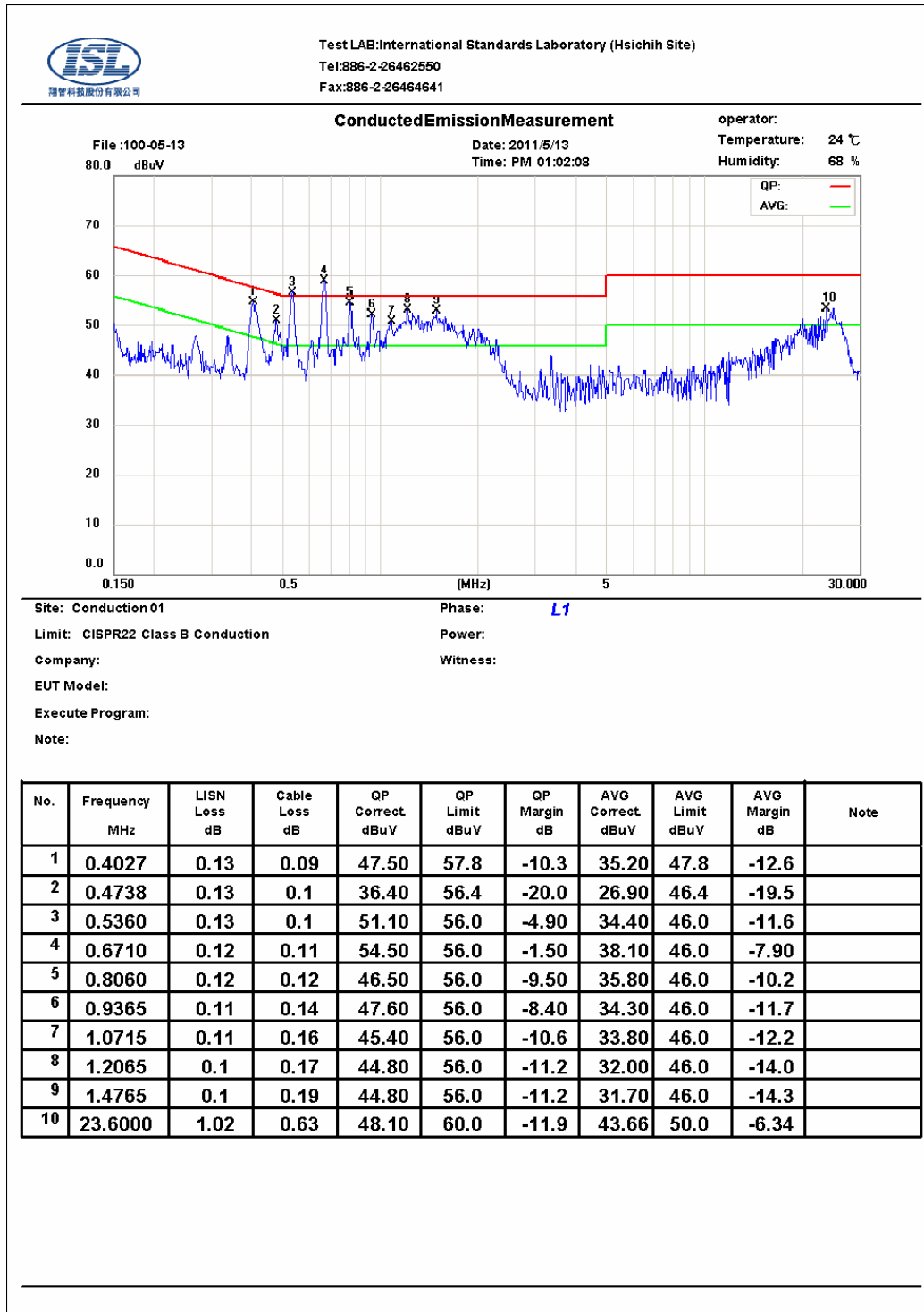

Note:

Margin = Corrected Amplitude - Limit

Corrected Amplitude = Receiver Reading + LISN Loss + Cable Loss

A margin of -8dB means that the emission is 8dB below the limit

The frequency spectrum graph is for final peak graph, and the attached table is for QP/AVG test result.

If peak data can pass, it will be shown in "QP/AVG Correct" column, if not, QP/AVG data will instead.

Table 2.2.2 Power Line Conducted Emissions (Neutral)

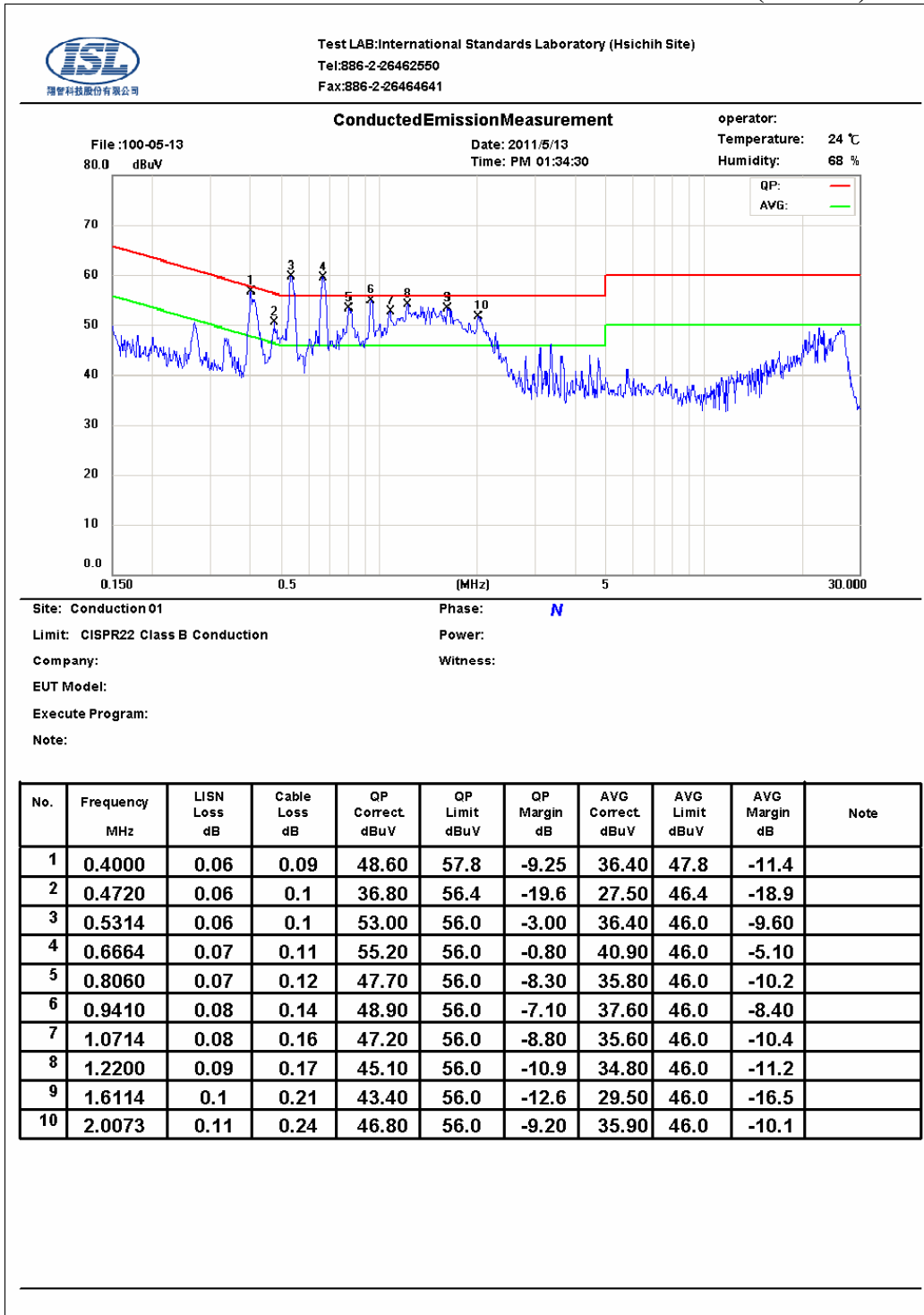

Note:

Margin = Corrected Amplitude - Limit

Corrected Amplitude = Receiver Reading + LISN Loss + Cable Loss

A margin of -8dB means that the emission is 8dB below the limit

The frequency spectrum graph is for final peak graph, and the attached table is for QP/AVG test result.

If peak data can pass, it will be shown in "QP/AVG Correct" column, if not, QP/AVG data will instead.

3. Telecommunication Port Conducted Emissions

3.1 Test Setup and Procedure

3.1.1 Test Setup

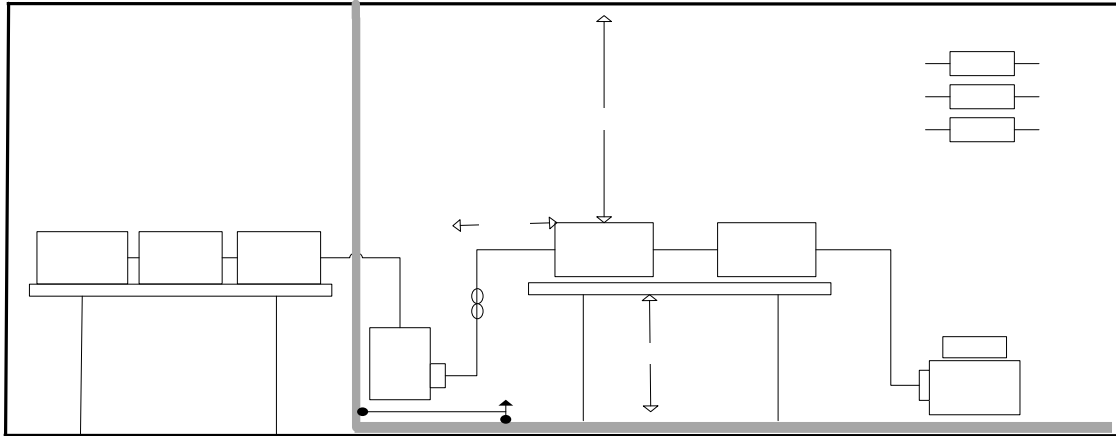

Shield

3.1.2 Test Procedure

The measurements are performed in a 3.5m x 3.4m x 2.5m shielded room, which referred as Conduction 01 test site, or a 3m x 3m x 2.3m test site, which referred as Conduction 02 test site. The EUT was placed on non-conduction 1.0m x 1.5m table, which is 0.8 meters above an earth-grounded.

The EUT, any support equipment, and any interconnecting cables were arranged and moved to get the maximum measurement.

Power to the EUT was provided through the LISN which has the Impedance (50 Ohm/50uH) vs. Frequency Characteristic in accordance with the standard. Power to the LISN was filtered to eliminate ambient signal interference and this filter was bonded to ground. Peripheral equipment to provide a functional system (support equipment) for EUT testing was powered through a ganged, metal power outlet box bonded to the ground. AC input power for the auxiliary power outlets was obtained from the same filtered source that provides input power to the LISN.

The highest emissions were analyzed in details by operating the spectrum analyzer in fixed tuned mode to determine the nature of the emissions and to provide information could be useful in reducing their amplitude.

3.1.3 EMI Receiver/Spectrum Analyzer Configuration (for the frequencies tested)

Frequency Range:	150KHz--30MHz
Detector Function:	Quasi-Peak / Average Mode
Resolution Bandwidth:	9KHz

EUT
LISN
Metal Ground Plane

3.2 Test Data: LAN--10M: Configuration 1

Table 3.2.1 Telecommunication Port Conducted Emission

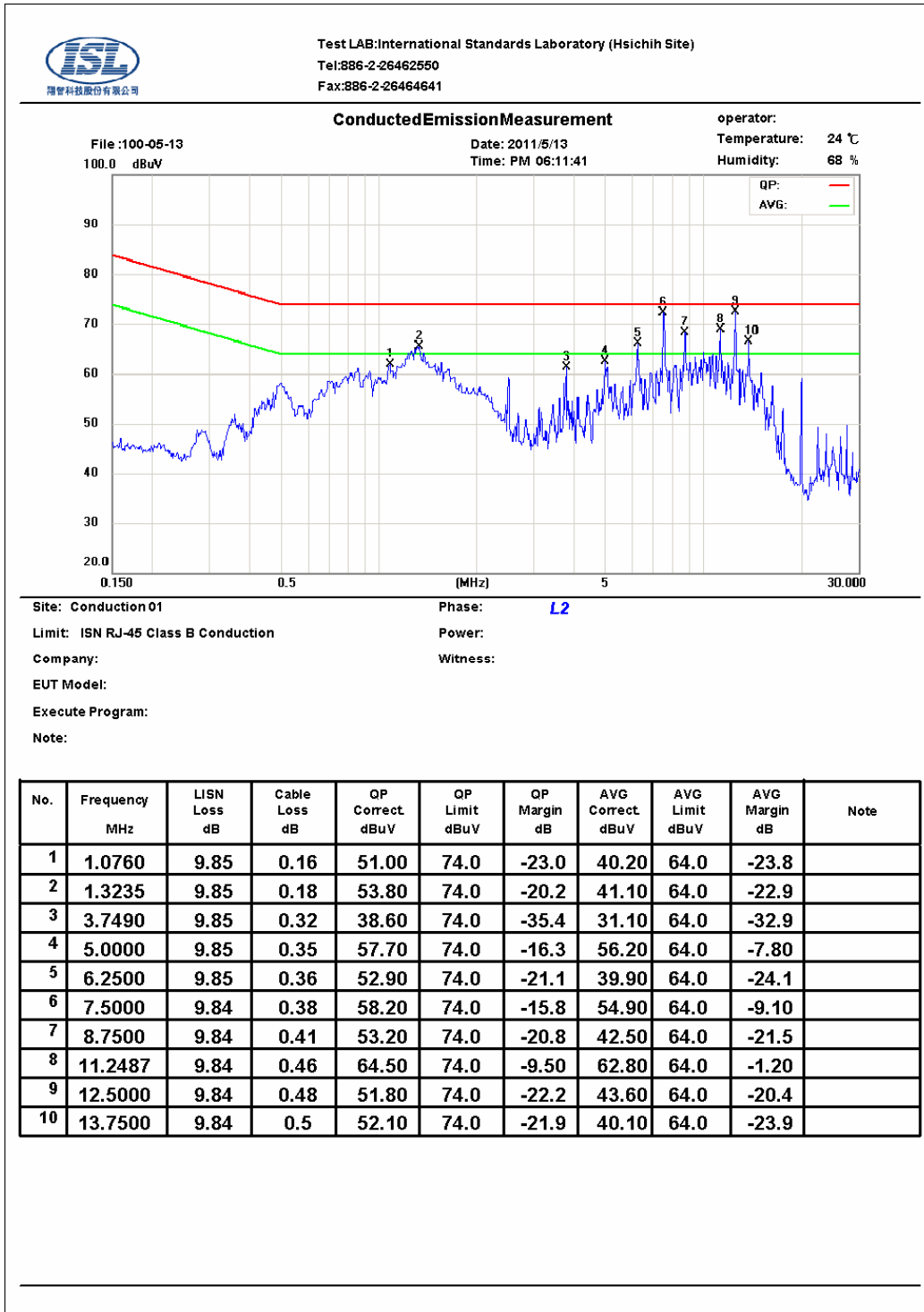

Note :

Margin = Corrected Amplitude - Limit

Corrected Amplitude = Receiver Reading + LISN Loss + Cable Loss

A margin of -8dB means that the emission is 8dB below the limit

The frequency spectrum graph is for final peak graph, and the attached table is for QP/AVG test result.

If peak data can pass, it will be shown in "QP/AVG Correct" column, if not, QP/AVG data will instead.

3.3 Test Data: LAN--100M: Configuration 1

Table 3.3.1 Telecommunication Port Conducted Emission

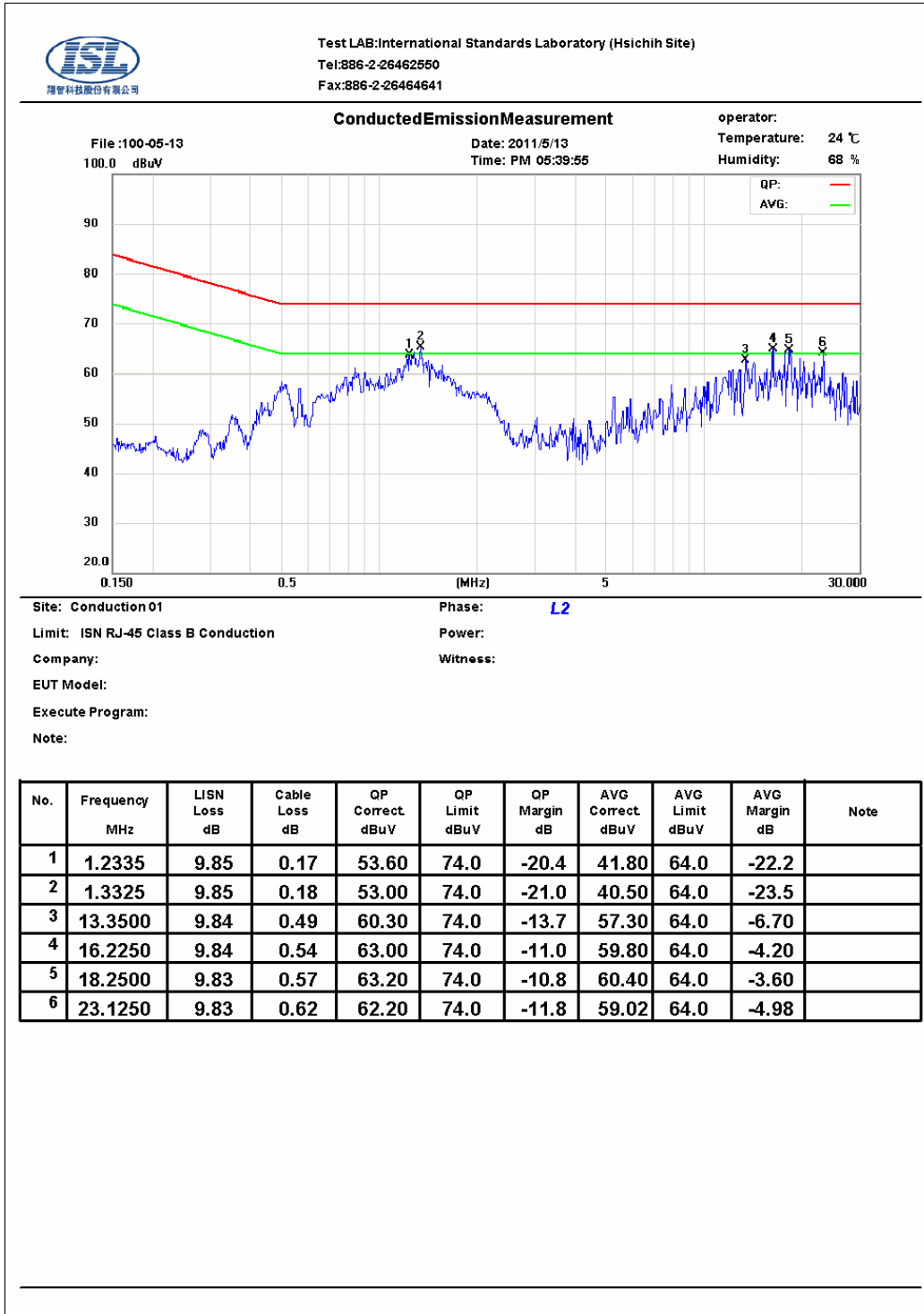

Note :

Margin = Corrected Amplitude - Limit

Corrected Amplitude = Receiver Reading + LISN Loss + Cable Loss

A margin of -8dB means that the emission is 8dB below the limit

The frequency spectrum graph is for final peak graph, and the attached table is for QP/AVG test result.

If peak data can pass, it will be shown in "QP/AVG Correct" column, if not, QP/AVG data will instead.

3.4 Test Data: LAN--GIGA: Configuration 1

Table 3.4.1 Telecommunication Port Conducted Emission

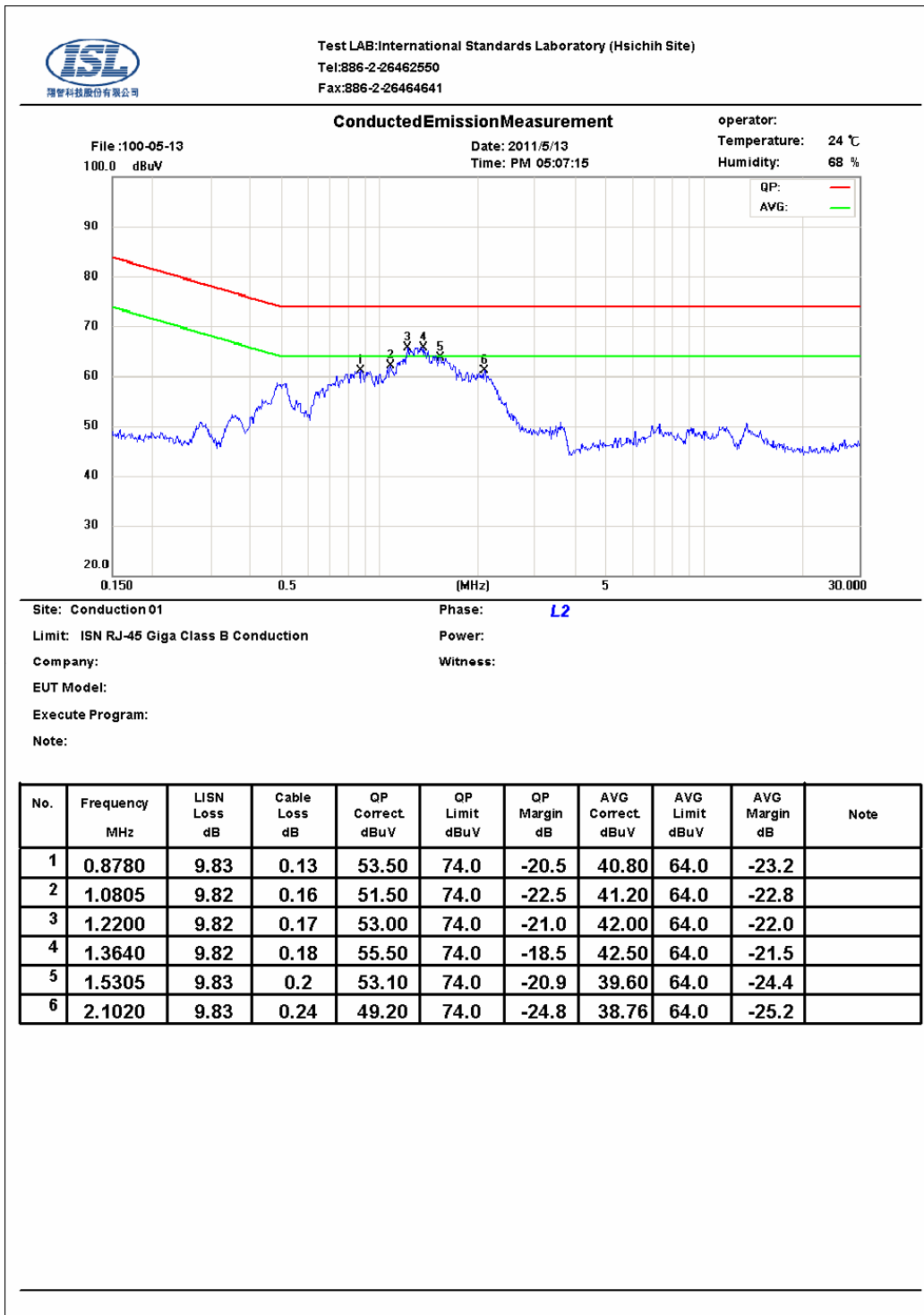

Note :

Margin = Corrected Amplitude - Limit

Corrected Amplitude = Receiver Reading + LISN Loss + Cable Loss

A margin of -8dB means that the emission is 8dB below the limit

The frequency spectrum graph is for final peak graph, and the attached table is for QP/AVG test result.

If peak data can pass, it will be shown in "QP/AVG Correct" column, if not, QP/AVG data will instead.

3.5 Test Data: LAN--10M: Configuration 2

Table 3.5.1 Telecommunication Port Conducted Emission

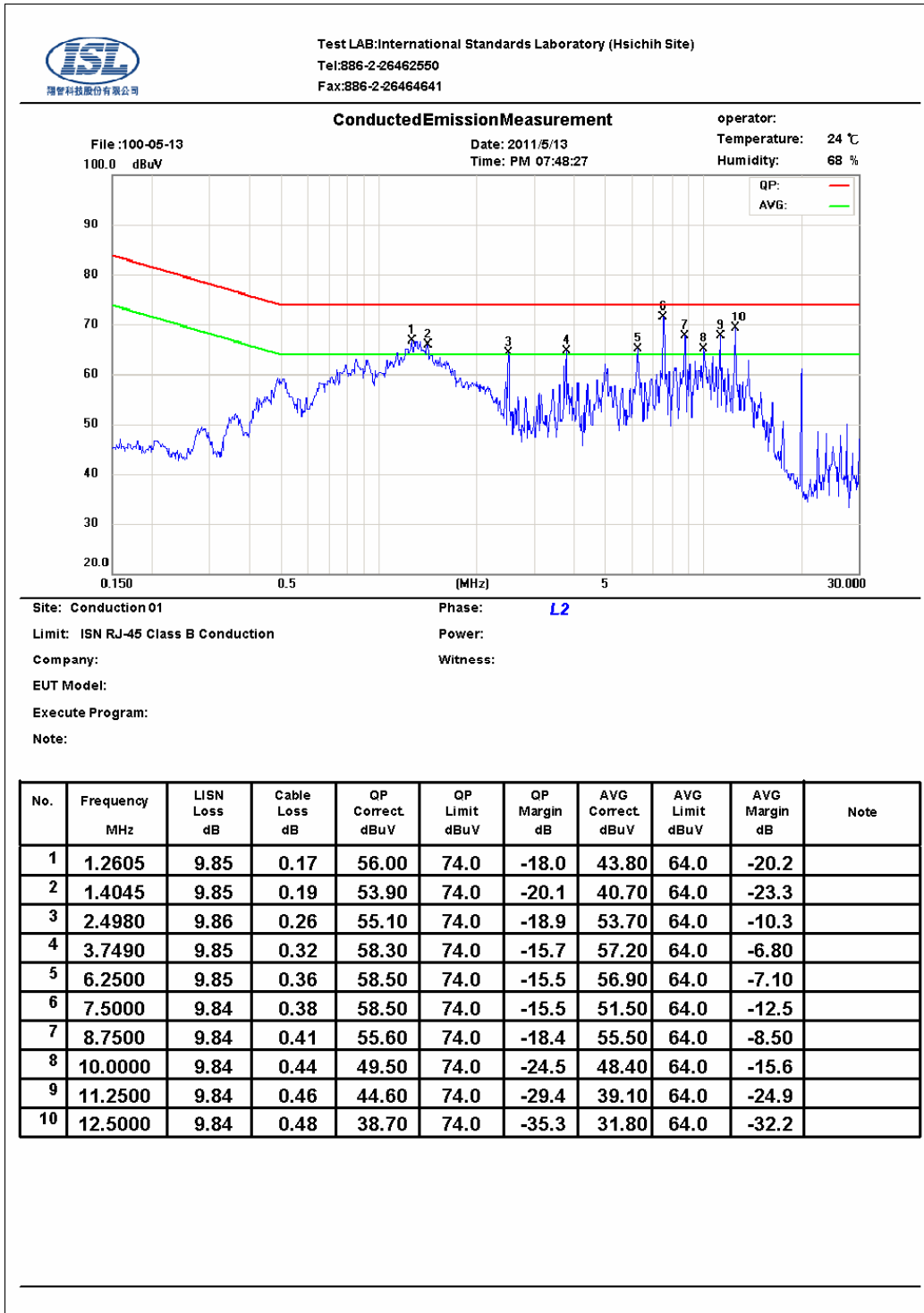

Note :

Margin = Corrected Amplitude - Limit

Corrected Amplitude = Receiver Reading + LISN Loss + Cable Loss

A margin of -8dB means that the emission is 8dB below the limit

The frequency spectrum graph is for final peak graph, and the attached table is for QP/AVG test result.

If peak data can pass, it will be shown in "QP/AVG Correct" column, if not, QP/AVG data will instead.

3.6 Test Data: LAN--100M: Configuration 2

Table 3.6.1 Telecommunication Port Conducted Emission

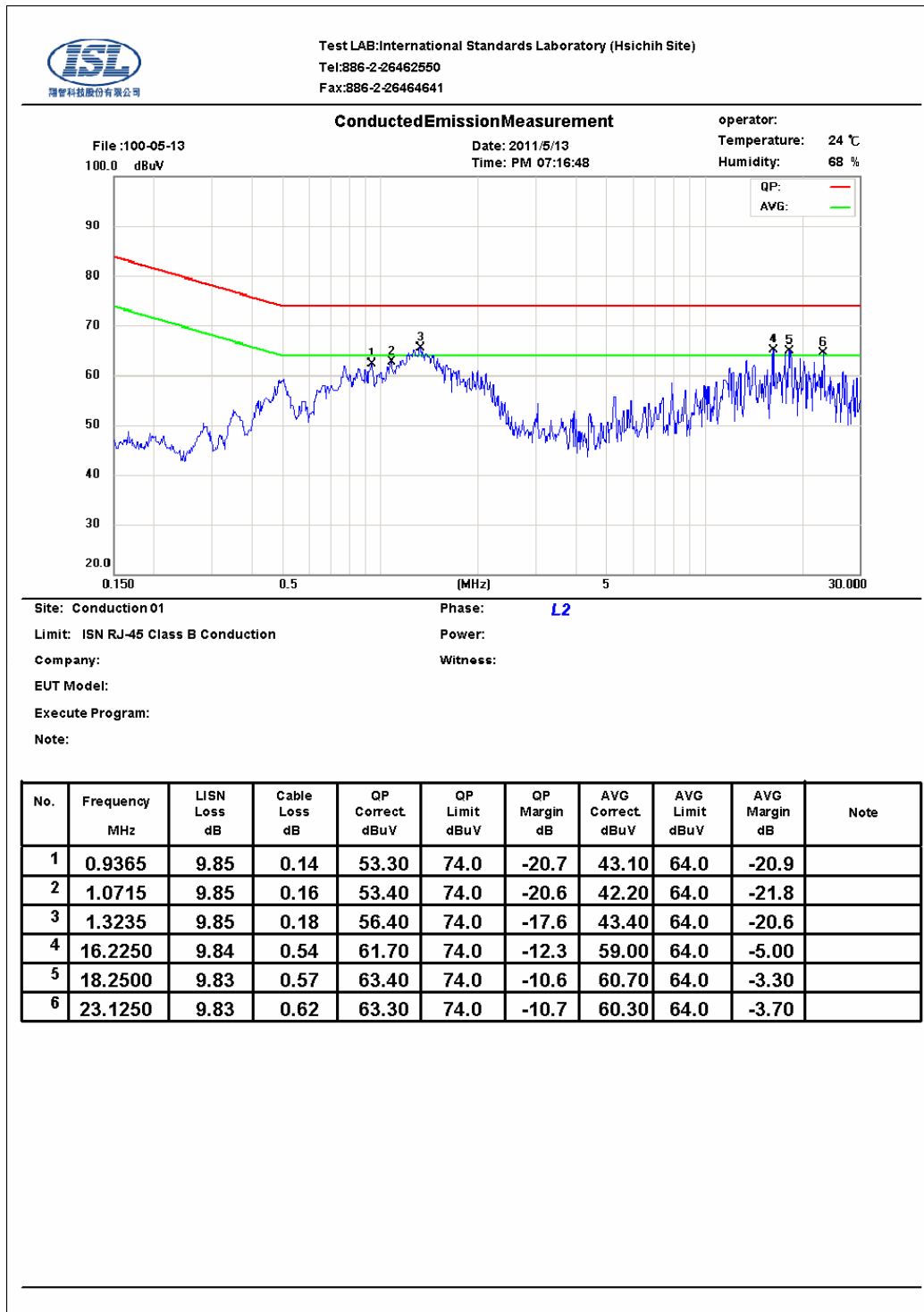

Note :

Margin = Corrected Amplitude - Limit

Corrected Amplitude = Receiver Reading + LISN Loss + Cable Loss

A margin of -8dB means that the emission is 8dB below the limit

The frequency spectrum graph is for final peak graph, and the attached table is for QP/AVG test result.

If peak data can pass, it will be shown in "QP/AVG Correct" column, if not, QP/AVG data will instead.

4. Radiated Disturbance Emissions

4.1 Test Setup and Procedure

4.1.1 Test Setup

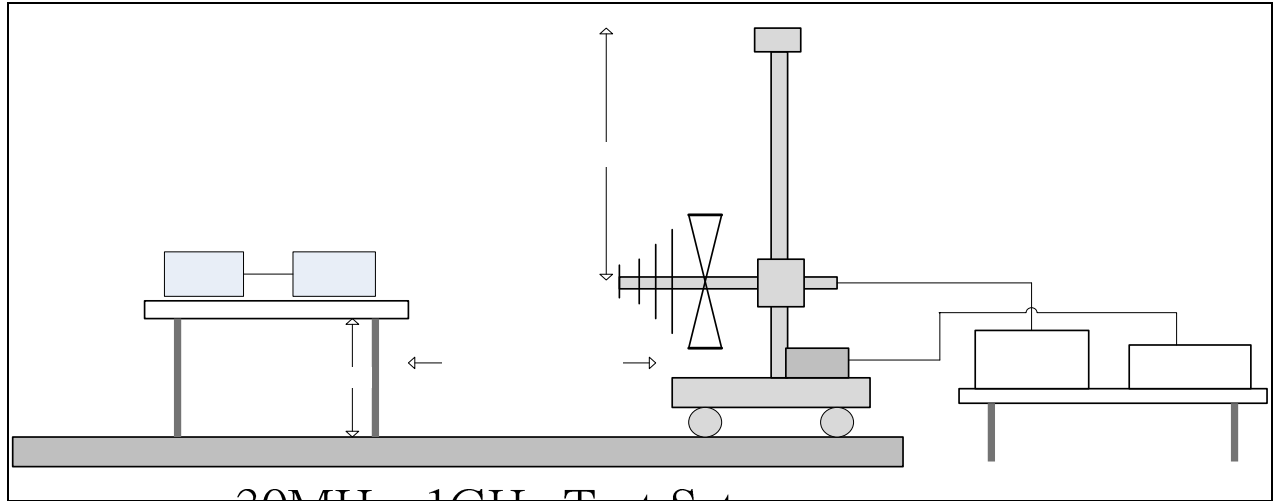

30MHz~1GHz Test Setup

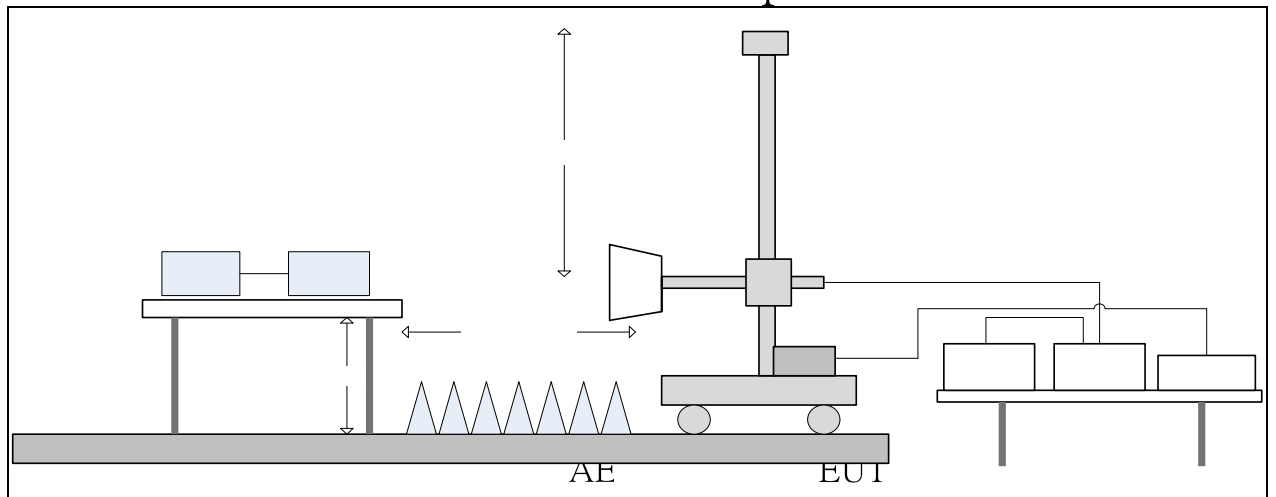

1m to

4.1.2 Test Procedure

The radiated emissions test will then be repeated on the open site or chamber to measure the amplitudes accurately and without the multiple reflections existing in the shielded room. The EUT and support equipment are set up on the turntable of one of 10 meter open field sites or 10 meter chamber. Desktop EUT are set up on a wooden stand and 0.8 meter above the ground or floor-standing arrangement shall be placed on the horizontal ground reference plane. The test volume for a height of up to 30 cm may be obstructed by absorber placed on the ground plane.

For the initial measurements, the receiving antenna is varied from 1.4 meter height and is changed in the vertical plane from vertical to horizontal polarization at each frequency. The highest emissions between 30 MHz to 1000 MHz were analyzed in details by operating the spectrum analyzer and/or EMI receiver in quasi-peak mode to determine the precise amplitude of the emissions. The highest emissions between 1GHz to 6GHz were analyzed in details by operating

the spectrum analyzer in peak and average mode to determine the precise amplitude of the emissions.

At the highest amplitudes observed, the EUT is rotated in the horizontal plane while changing the antenna polarization in the vertical plane to maximize the reading. The interconnecting cables were arranged and moved to get the maximum measurement. Once the maximum reading is obtained, the antenna elevation and polarization will be varied between specified limits to maximize the readings.

The highest internal source of an EUT is defined as the highest frequency generated or used within the EUT or on which the EUT operates or tunes. If the highest frequency of the internal sources of the EUT is less than 108 MHz, the measurement shall only be made up to 1 GHz. If the highest frequency of the internal sources of the EUT is between 108 MHz and 500 MHz, the measurement shall only be made up to 2 GHz. If the highest frequency of the internal sources of the EUT is between 500 MHz and 1 GHz, the measurement shall only be made up to 5 GHz. If the highest frequency of the internal sources of the EUT is above 1 GHz, the measurement shall be made up to 5 times the highest frequency or 6 GHz, whichever is less.

4.1.3 Spectrum Analyzer Configuration (for the frequencies tested)

Frequency Range:	30MHz--1000MHz
Detector Function:	Quasi-Peak Mode
Resolution Bandwidth:	120KHz
Frequency Range:	Above 1 GHz to 6 GHz
Detector Function:	Peak/Average Mode
Resolution Bandwidth:	1MHz

4.2 Radiation Test Data: Configuration 1

Table 4.2.1 Radiated Emissions (Horizontal)

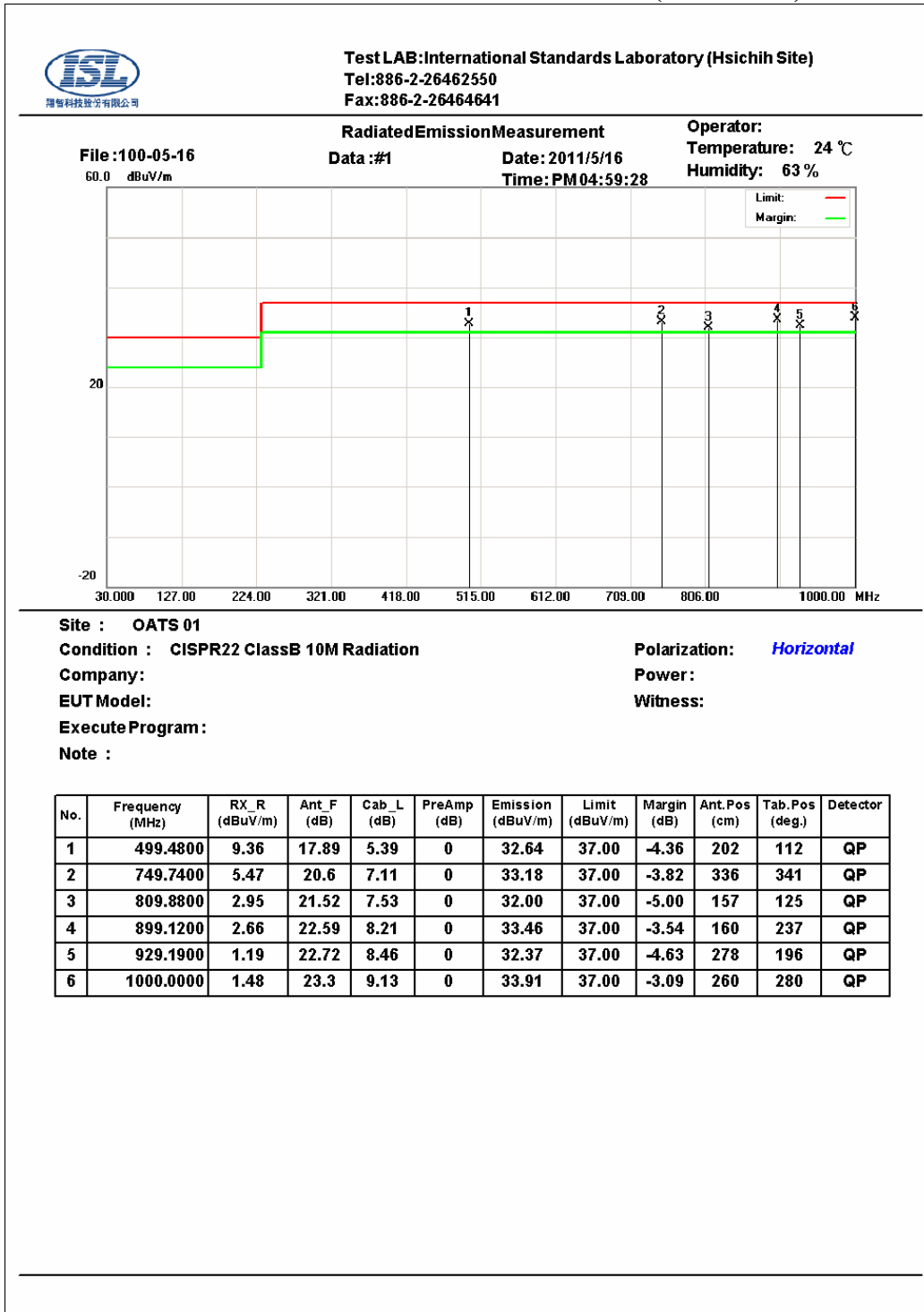

* Note:

Margin = Corrected Amplitude – Limit

Corrected Amplitude = Radiated Amplitude + Antenna Correction Factor + Cable Loss – Pre-Amplifier Gain

A margin of -8dB means that the emission is 8dB below the limit

BILOG Antenna Distance: 10 meters

Below 1GHz test, if the peak measured value meets the QP limit, it is unnecessary to perform the QP measurement.



Address: No.120, Lane 180, San Ho Tsuen, Hsin Ho Road
Lung-Tan Hsiang, Tao Yuan Conty, Taiwan R.O.C.
Tel: 03-4071718

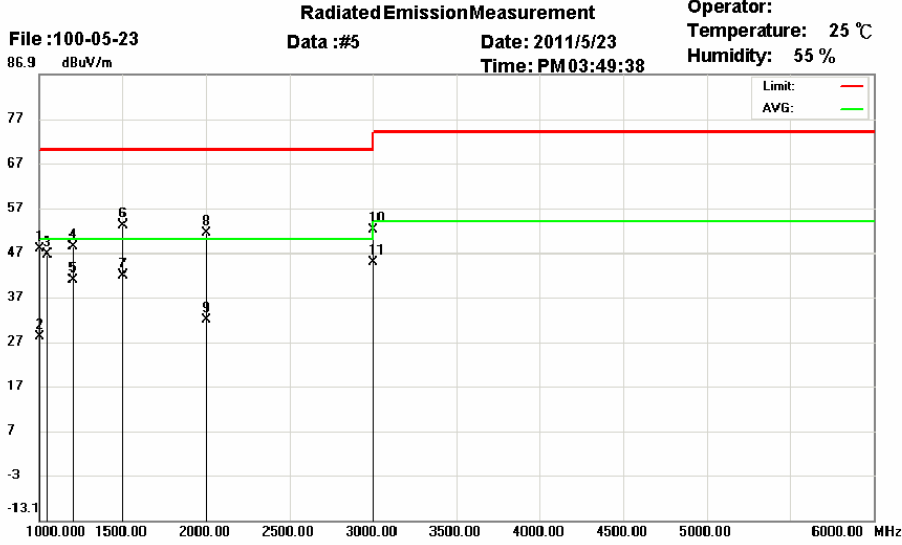

Site : Chamber 14 Polarization: **Horizontal**
Condition : CISPR22 ClassB Radiation(Peak) Power :
Company : Witness:
EUT Model :
Execute Program :
Note :

Mk.	Frequency (MHz)	RX_R (dBuV/m)	Ant_F (dB)	Cab_L (dB)	PreAmp (dB)	Emission (dBuV/m)	Limit (dBuV/m)	Margin (dB)	Ant.Pos (cm)	Tab.Pos (deg.)	Detector
1	1000.040	63.92	28.6	1.45	46.3	47.67	70.00	-22.33	146	27	peak
2	1000.040	44.18	28.6	1.45	46.3	27.93	50.00	-22.07	146	27	AVG
3	1050.000	62.74	28.6	1.48	46.3	46.52	70.00	-23.48	314	265	peak
4	1200.000	64.41	28.6	1.59	46.3	48.30	70.00	-21.70	184	97	peak
5	1200.000	56.84	28.6	1.59	46.3	40.73	50.00	-9.27	184	97	AVG
6	1500.030	68.92	28.6	1.79	46.3	53.01	70.00	-16.99	287	149	peak
7	1500.030	57.65	28.6	1.79	46.3	41.74	50.00	-8.26	287	149	AVG
8	1999.400	63.55	32.1	2.09	46.4	51.34	70.00	-18.66	100	333	peak
9	1999.400	43.91	32.1	2.09	46.4	31.70	50.00	-18.30	100	333	AVG
10	2999.950	62.51	33.6	2.63	46.6	52.14	70.00	-17.86	294	202	peak
11	2999.950	55.21	33.6	2.63	46.6	44.84	50.00	-5.16	294	202	AVG

*:Maximum data x:Over limit !:over margin

* Note:

Margin = Corrected Amplitude – Limit

Corrected Amplitude = Radiated Amplitude + Antenna Correction Factor + Cable Loss – Pre-Amplifier Gain

A margin of -8dB means that the emission is 8dB below the limit

Horn Antenna Distance: 3 meters

Above 1GHz test, if the peak measured value meets the average limit, it is unnecessary to perform the average measurement.

Table 4.2.2 Radiated Emissions (Vertical)

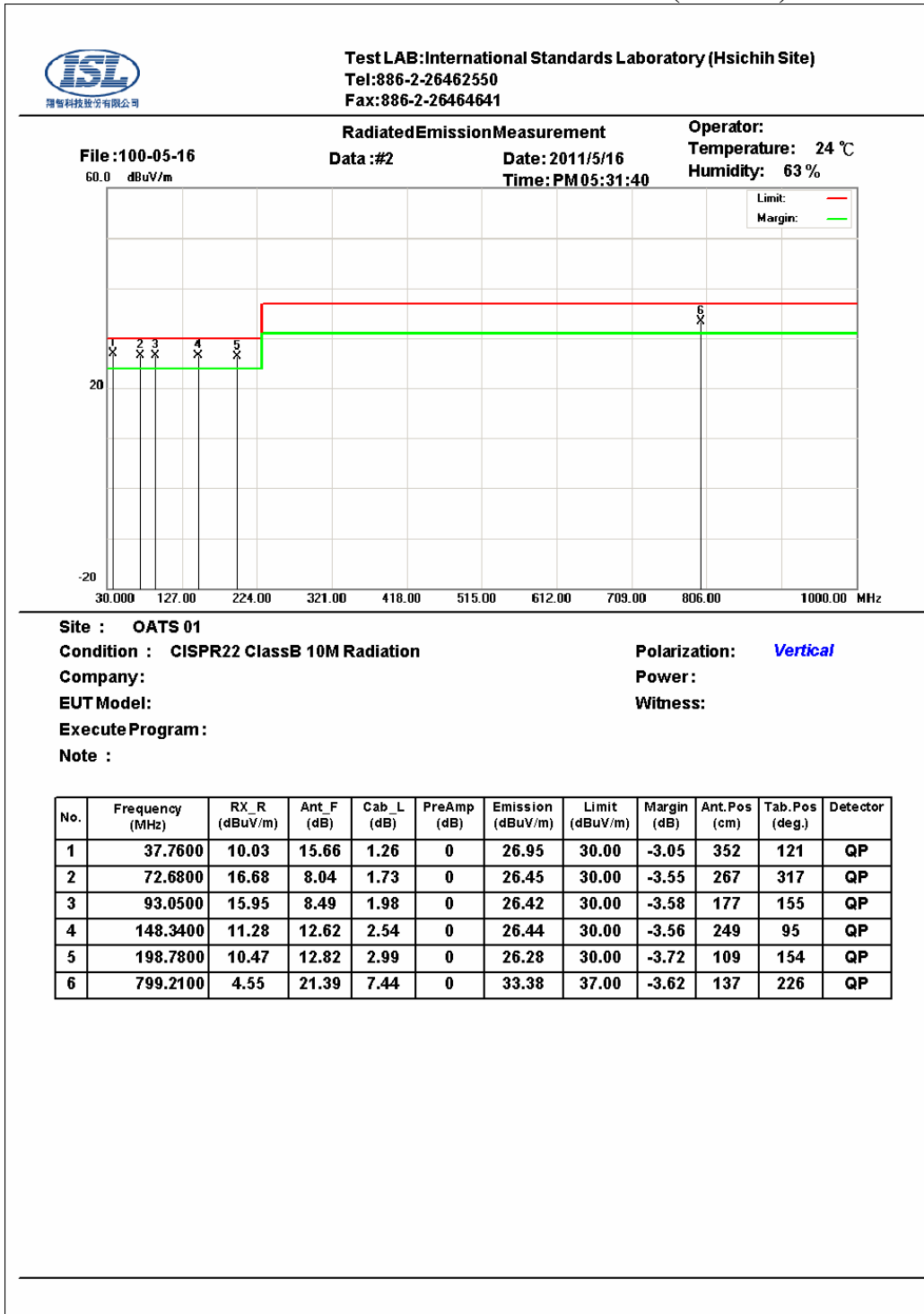

* Note:

Margin = Corrected Amplitude – Limit

Corrected Amplitude = Radiated Amplitude + Antenna Correction Factor + Cable Loss – Pre-Amplifier Gain

A margin of -8dB means that the emission is 8dB below the limit

BILOG Antenna Distance: 10 meters

Below 1GHz test, if the peak measured value meets the QP limit, it is unnecessary to perform the QP measurement.



Address: No.120, Lane 180, San Ho Tsuen, Hsin Ho Road
Lung-Tan Hsiang, Tao Yuan Conty, Taiwan R.O.C.
Tel: 03-4071718

File : 100-05-23
86.9 dBuV/m
Radiated Emission Measurement
Data :# 6
Date : 2011/5/23
Time : PM 04:22:16
Operator :
Temperature : 25 °C
Humidity : 55 %

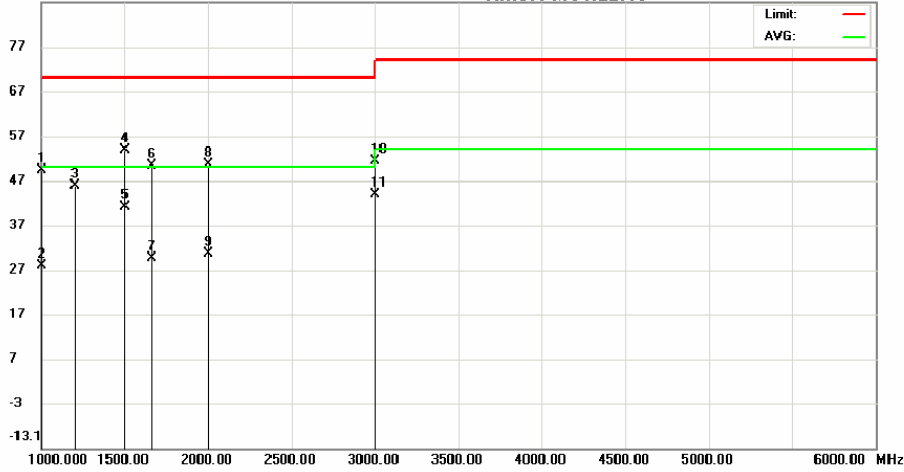

Site : Chamber 14
Condition : CISPR22 ClassB Radiation(Peak)
Company :
EUT Model :
Execute Program :
Note :
Polarization : Vertical
Power :
Witness :

Mk.	Frequency (MHz)	RX_R (dBuV/m)	Ant_F (dB)	Cab_L (dB)	PreAmp (dB)	Emission (dBuV/m)	Limit (dBuV/m)	Margin (dB)	Ant.Pos (cm)	Tab.Pos (deg.)	Detector
1	1000.140	65.42	28.6	1.45	46.3	49.17	70.00	-20.83	187	44	peak
2	1000.140	44.09	28.6	1.45	46.3	27.84	50.00	-22.16	187	44	AVG
3	1200.000	61.78	28.6	1.59	46.3	45.67	70.00	-24.33	276	201	peak
4	1499.860	69.75	28.6	1.79	46.3	53.84	70.00	-16.16	190	165	peak
5	1499.860	56.83	28.6	1.79	46.3	40.92	50.00	-9.08	190	165	AVG
6	1662.900	64.88	29.74	1.89	46.33	50.18	70.00	-19.82	100	327	peak
7	1662.900	44.34	29.74	1.89	46.33	29.64	50.00	-20.36	100	327	AVG
8	1997.400	62.72	32.08	2.09	46.4	50.49	70.00	-19.51	100	307	peak
9	1997.400	42.88	32.08	2.09	46.4	30.65	50.00	-19.35	100	307	AVG
10	3000.060	61.63	33.6	2.63	46.6	51.26	74.00	-22.74	161	196	peak
11	3000.060	54.19	33.6	2.63	46.6	43.82	54.00	-10.18	161	196	AVG

*:Maximum data x:Over limit !:over margin

* Note:

Margin = Corrected Amplitude – Limit

Corrected Amplitude = Radiated Amplitude + Antenna Correction Factor + Cable Loss – Pre-Amplifier Gain

A margin of -8dB means that the emission is 8dB below the limit

Horn Antenna Distance: 3 meters

Above 1GHz test, if the peak measured value meets the average limit, it is unnecessary to perform the average measurement.

5. Electrostatic discharge (ESD) immunity

5.1 Electrostatic discharge (ESD) immunity test

Port:	Enclosure
Basic Standard:	EN 61000-4-2/ IEC EN61000-4-2 (details referred to Sec 1.2)
Test Level:	Air +/- 2 kV, +/- 4 kV, +/- 8 kV Contact +/- 2 kV, +/- 4 kV
Criteria:	B
Test Procedure	refer to ISL QA -T4-E-S7
Temperature:	24 °C
Humidity:	53%

Selected Test Point

Air: discharges were applied to slots, aperture or insulating surfaces. 10 single air discharges were applied to each selected points.

Contact: Total 200 discharges minimum were to the selected contact points.

Indirect Contact Points: 25 discharges were applied to center of one edge of VCP and each EUT side of HCP with 10 cm away from EUT.

For final test points, please refer to EUT 30 to EUT 31 of Appendix: Photographs of EUT. Red arrow lines indicate the contact points, and blue arrow lines indicate the air points.

Test Setup

EUT is 1m from the wall and other metallic structure. When Battery test mode is needed, a cable with one 470KΩ resistor at two rare ends is connected from metallic part of EUT and screwed to HCP.

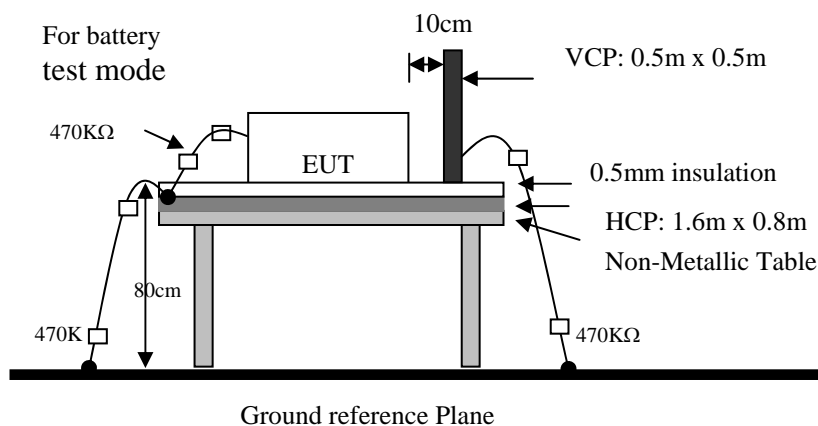

Test Result

Performance of EUT complies with the given specification.

6. Radio-Frequency, Electromagnetic Field immunity

6.1 Radio-Frequency, Electromagnetic Field immunity test

Port:	Enclosure
Basic Standard:	EN 61000-4-3/ IEC EN61000-4-3 (details referred to Sec 1.2)
Test Level::	3 V/m
Modulation:	AM 1KHz 80%
Frequency range:	80 MHz~1 GHz
Frequency Step:	1% of last step frequency
Dwell time:	3s
Polarization:	Vertical and Horizontal
EUT Azimuth Angle	☒0° ☒90° ☒180° ☒270°
Criteria:	A
Test Procedure	refer to ISL QA -T4-E-S8
Temperature:	24°C
Humidity:	60%

Test Setup

The field sensor is placed at one calibration grid point to check the intensity of the established fields on both polarizations. EUT is adjusted to have each side of EUT face coincident with the calibration plane. A CCD camera and speakers are used to monitor the condition of EUT for the performance judgment.

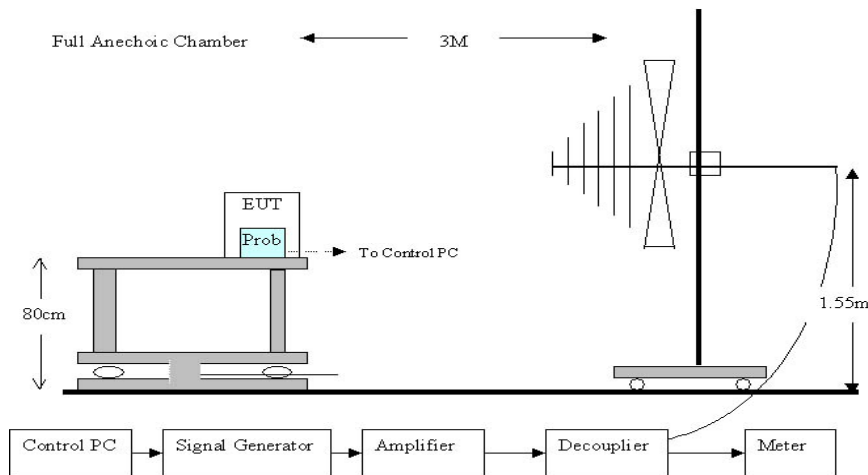

Test Result

Performance of EUT complies with the given specification.

7. Electrical Fast transients/burst immunity

7.1 Electrical Fast transient/burst immunity test

Port:	AC mains; Twisted Pair LAN Port
Basic Standard:	EN 61000-4-4/ IEC EN61000-4-4 (details referred to Sec 1.2)
Test Level:	AC Power Port: +/- 1 kV Twisted Pair LAN Port (I/O Cables): +/- 0.5 kV
Rise Time:	5ns
Hold Time:	50ns
Repetition Frequency:	5KHz
Criteria:	B
Test Procedure	refer to ISL QA -T4-E-S9
Temperature:	25 °C
Humidity:	58%

Test Procedure

The EUT was setup on a nonconductive table 0.1 m above a reference ground plane.

Test Points	Polarity	Result	Comment
Line	+	N	60 sec
	-	N	60 sec
Neutral	+	N	60 sec
	-	N	60 sec
Ground	+	N	60 sec
	-	N	60 sec
Line to Neutral	+	N	60 sec
	-	N	60 sec
Line to Ground	+	N	60 sec
	-	N	60 sec
Neutral to Ground	+	N	60 sec
	-	N	60 sec
Line to Neutral to Ground	+	N	60 sec
	-	N	60 sec
Capacitive coupling clamp	+	N	60 sec
	-	N	60 sec

Note: 'N' means normal, the EUT function is correct during the test.

Test Setup

EUT is at least 50cm from the conductive structure.

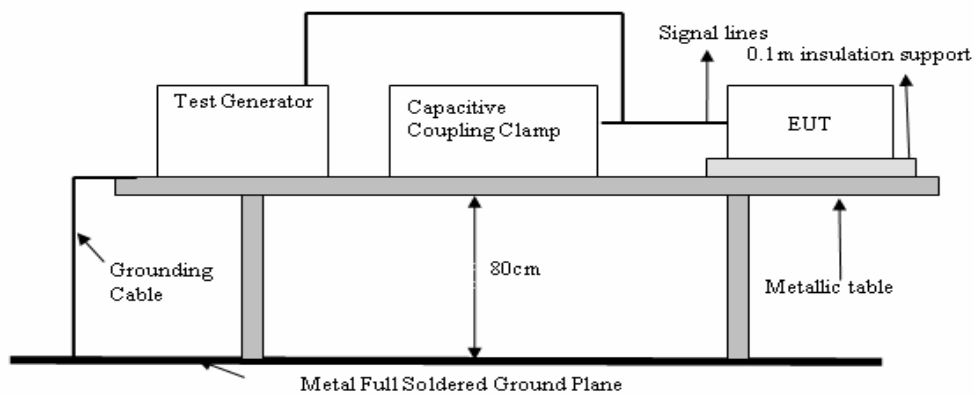
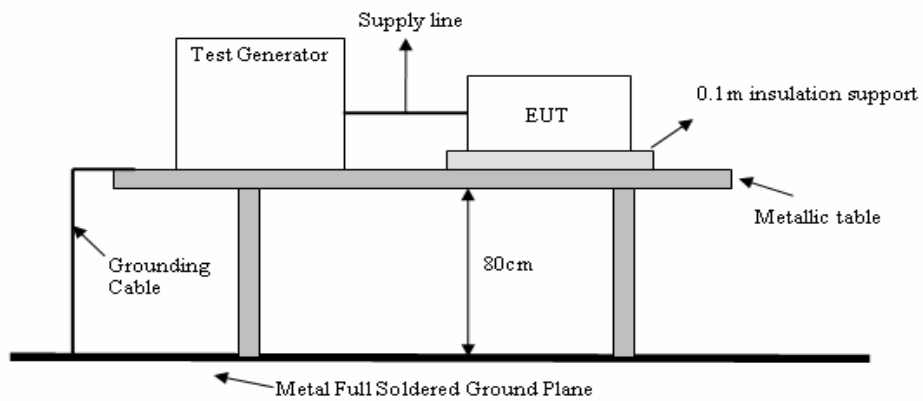

Test Result

Performance of EUT complies with the given specification.

8. Surge Immunity

8.1 Surge immunity test

Port:	AC mains
Basic Standard:	EN 61000-4-5/ IEC EN61000-4-5 (details referred to Sec 1.2)
Test Level:	AC Power Port: Line to Line: +/- 0.5 kV, +/- 1 kV Line to Earth: +/- 0.5 kV, +/- 1 kV, +/- 2kV
Rise Time:	1.2us
Hold Time:	50us
Repetition Rate:	30 second
Angle:	☒0° ☒90° ☒180° ☒270°
Criteria:	B
Test Procedure	refer to ISL QA -T4-E-S10
Temperature:	25°C
Humidity:	58%

Test Setup

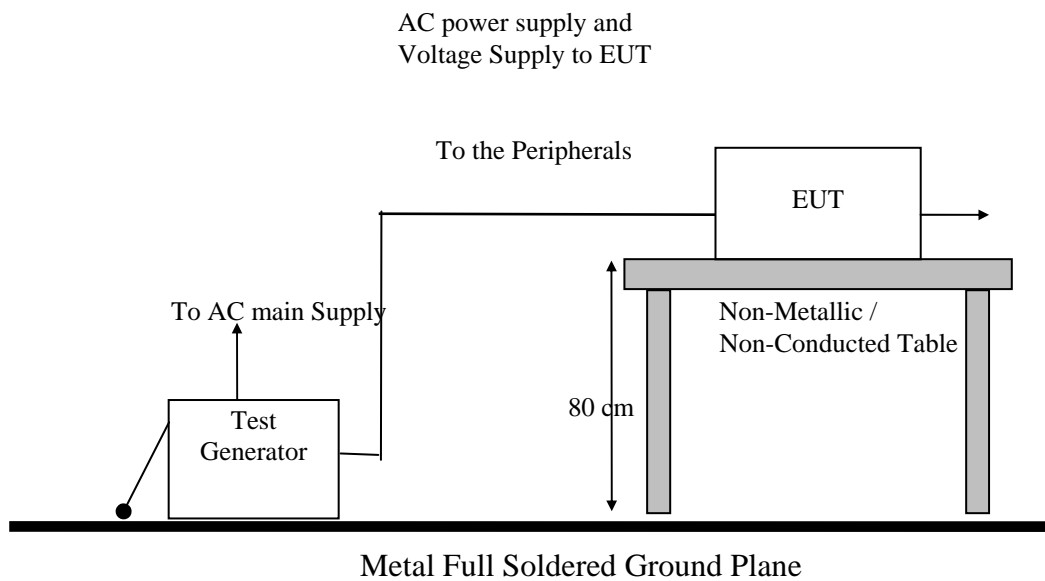

Test Result

Performance of EUT complies with the given specification.

9. Immunity to Conductive Disturbance

9.1 Immunity to Conductive Disturbance

Port:	AC mains; Twisted Pair LAN Port
Basic Standard:	EN 61000-4-6/ IEC EN61000-4-6 (details referred to Sec 1.2)
Test Level::	3 V
Modulation:	AM 1KHz 80%
Frequency range:	0.15 MHz - 80MHz
Frequency Step:	1% of last Frequency
Dwell time:	3s
Criteria:	A
CDN Type:	CDN M2+M3, CDN T2, CDN T4, CDN T8, EM Clamp
Test Procedure	refer to ISL QA -T4-E-S11
Temperature:	24°C
Humidity:	53%

Test Setup

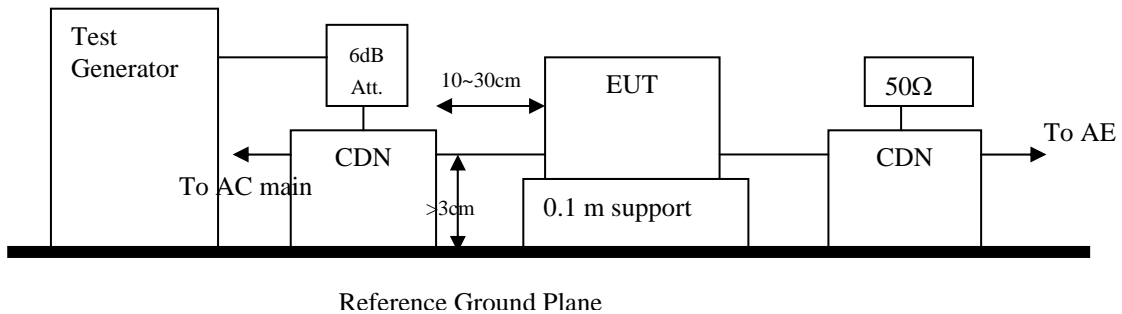

Test Result

Performance of EUT complies with the given specification.

10. Power Frequency Magnetic Field immunity

10.1 Power Frequency Magnetic field immunity test

Port:	Enclosure
Basic Standard:	EN 61000-4-8/ IEC EN61000-4-8 (details referred to Sec 1.2)
Test Level:	1A/m
Polarization:	X, Y, Z
Criteria:	A
Test Procedure	refer to ISL QA -T4-E-S12
Temperature:	25°C
Humidity:	58%

Test Setup

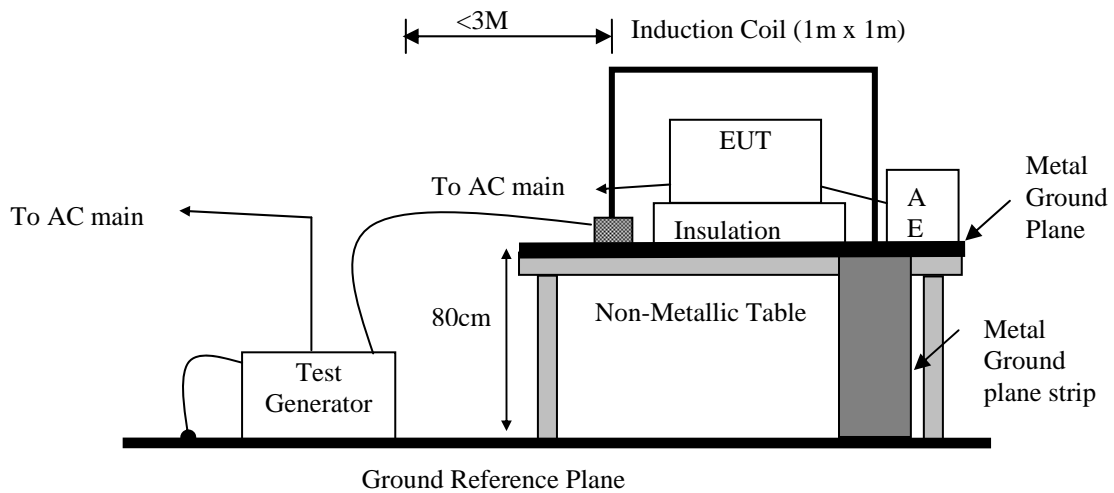

Test Result

Performance of EUT complies with the given specification.

11. Voltage Dips, Short Interruption and Voltage Variation immunity

11.1 Voltage Dips, Short Interruption and Voltage Variation immunity test

Port:	AC mains
Basic Standard:	EN 61000-4-11/ IEC EN61000-4-11 (details referred to Sec 1.2)
Test Level: Criteria:	>95% in 0.5 period B
Test Level: Criteria:	30% in 25 period C
Test Level: Criteria:	>95% in 250 period C
Phase:	0°; 180°
Test intervals:	3 times with 10s each
Test Procedure	refer to ISL QA -T4-E-S13
Temperature:	25°C
Humidity:	58%

Test Setup

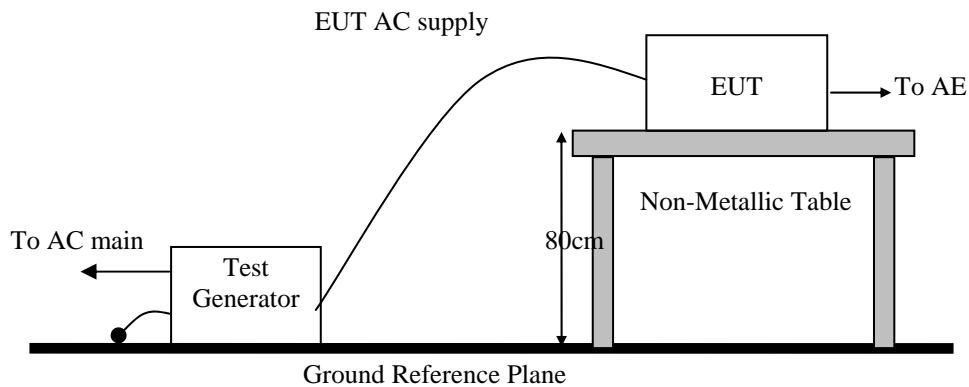

Test Result

Performance of EUT complies with the given specification.

12. Harmonics

12.1 Harmonics test

Port:	AC mains
Active Input Power:	>75W
Basic Standard:	EN61000-3-2/IEC 61000-3-2 (details referred to Sec 1.2)
Test Duration:	2.5min
Class:	D
Test Procedure	refer to ISL QA -T4-E-S14
Temperature:	24°C
Humidity:	59%

Test Procedure

The EUT is supplied in series with shunts or current transformers from a source having the same nominal voltage and frequency as the rated supply voltage and frequency of the EUT. The EUT is configured to its rated current with additional resistive load when the testing is performed.

Equipment having more than one rated voltage shall be tested at the rated voltage producing the highest harmonics as compared with the limits.

Result

Performance of EUT complies with the given specification.

Test Data

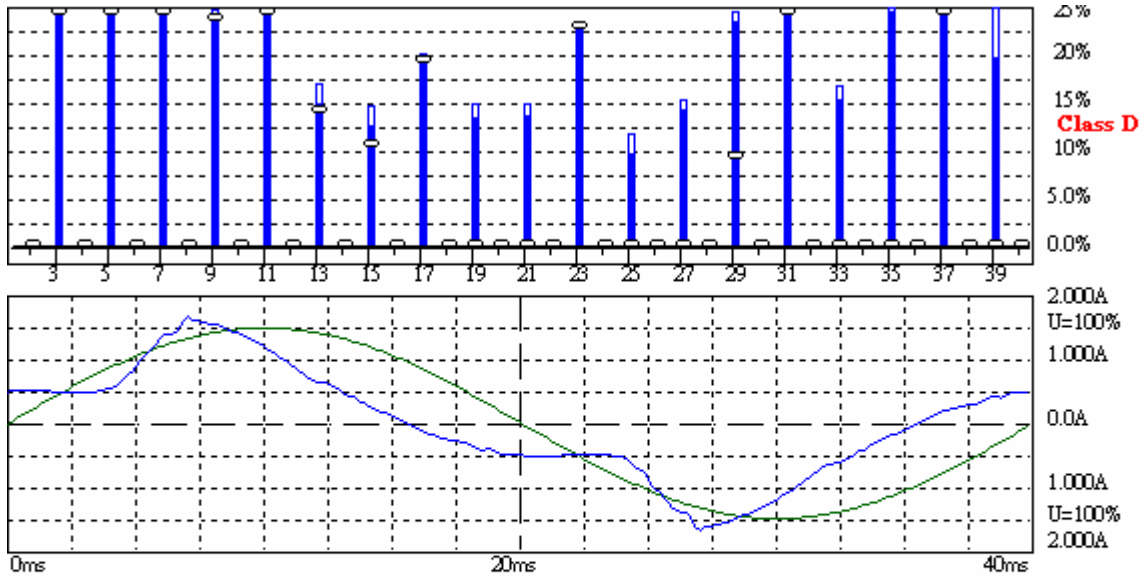

Harmonic Emission - IEC 61000-3-2 , EN 61000-3-2 , (EN60555-2)

2011/5/23 PM 04:48:3

Urms = 229.9 V	P = 158.2 W	THC = 0.275 A	Range: 2 A
Irms = 0.827 A	pf = 0.832	Pmax = 159.5 W	V-nom: 230 V
			TestTime: 5 min (100%)

Test completed, Result: PASSED

HAR-1000 EMC-Return

Urms = 229.9V Freq = 50.013 Range: 2 A
 Irms = 0.827A Ipk = 1.683A cf = 2.034
 P = 158.2W S = 190.2VA pf = 0.832
 THDi = 33.3 % THDu = 0.10 % Class D

Test - Time : 5min (100 %)

Limit Reference: Pmax = 159.45W

Test completed, Result: PASSED

Order	Freq. [Hz]	Iavg [A]	Iavg%L [%]	Irms [A]	Irms%L [%]	I _{max} [A]	I _{max} %L [%]	Limit [A]	Status
1	50	0.7776		0.7794		0.7864			
2	100	0.0122		0.0117		0.0148			
3	150	0.2406	44.385	0.2413	44.516	0.2417	44.583	0.5421	
4	200	0.0078		0.0076		0.0098			
5	250	0.1156	38.169	0.1161	38.319	0.1168	38.561	0.3030	
6	300	0.0060		0.0059		0.0076			
7	350	0.0504	31.582	0.0508	31.848	0.0524	32.843	0.1595	
8	400	0.0005		0.0042		0.0054			
9	450	0.0189	23.722	0.0192	24.039	0.0195	24.498	0.0797	
10	500	0.0000		0.0032		0.0043			
11	550	0.0151	27.112	0.0155	27.779	0.0164	29.310	0.0558	
12	600	0.0000		0.0021		0.0028			
13	650	0.0066	13.959	0.0070	14.735	0.0079	16.803	0.0472	
14	700	0.0000		0.0018		0.0024			
15	750	0.0043	10.431	0.0050	12.229	0.0059	14.317	0.0409	
16	800	0.0000		0.0012		0.0016			
17	850	0.0069	19.127	0.0068	18.930	0.0072	19.945	0.0361	
18	900	0.0000		0.0009		0.0011			
19	950	0.0000	0.0000	0.0043	13.223	0.0048	14.735	0.0323	
20	1000	0.0000		0.0006		0.0007			
21	1050	0.0000	0.0000	0.0039	13.363	0.0043	14.615	0.0292	
22	1100	0.0000		0.0005		0.0006			
23	1150	0.0061	22.906	0.0061	22.868	0.0062	23.325	0.0267	
24	1200	0.0000		0.0006		0.0007			
25	1250	0.0000	0.0000	0.0023	9.4453	0.0028	11.434	0.0246	
26	1300	0.0000		0.0007		0.0009			
27	1350	0.0000	0.0000	0.0032	13.959	0.0034	15.033	0.0227	
28	1400	0.0000		0.0005		0.0007			
29	1450	0.0019	8.9872	0.0049	23.067	0.0051	24.220	0.0212	
30	1500	0.0000		0.0009		0.0010			
31	1550	0.0070	35.552	0.0071	35.753	0.0074	37.602	0.0198	
32	1600	0.0000		0.0007		0.0009			
33	1650	0.0000	0.0000	0.0028	15.093	0.0031	16.405	0.0186	
34	1700	0.0000		0.0009		0.0011			
35	1750	0.0000	0.0000	0.0043	24.359	0.0045	25.751	0.0175	
36	1800	0.0000		0.0006		0.0010			
37	1850	0.0084	50.468	0.0085	51.502	0.0087	52.238	0.0166	
38	1900	0.0000		0.0010		0.0012			
39	1950	0.0000	0.0000	0.0031	19.388	0.0040	25.592	0.0157	
40	2000	0.0000		0.0010		0.0012			

13. Voltage Fluctuations

13.1 Voltage Fluctuations test

Port:	AC mains
Basic Standard:	EN61000-3-3/IEC61000-3-3 (details referred to Sec 1.2)
Test Procedure	refer to ISL QA -T4-E-S14
Observation period:	For Pst 10min For Plt 2 hours
Temperature:	24°C
Humidity:	59%

Test Procedure

The EUT is supplied in series with reference impedance from a power source with the voltage and frequency as the nominal supply voltage and frequency of the EUT.

Result

Performance of EUT complies with the given specification.

Test Data

10Min

Flickermeter 1000-4-15 for 230V/50Hz

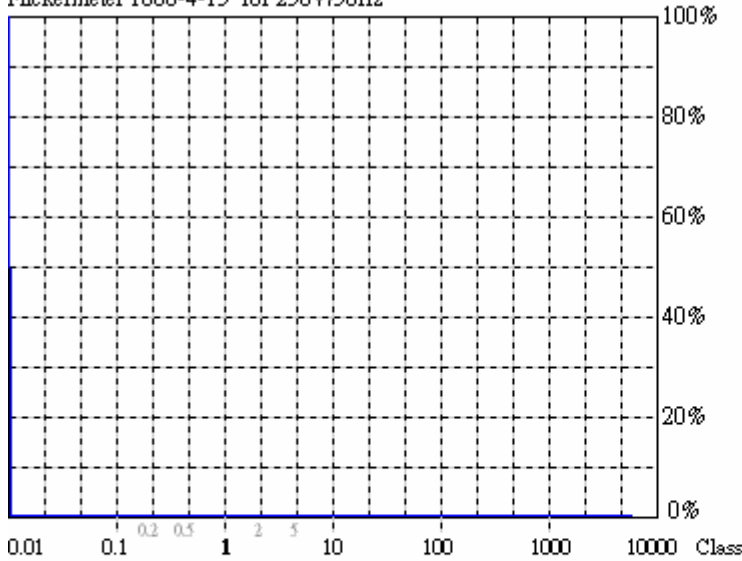

Actual Flicker (Fli): 0.00
Short-term Flicker (Pst): 0.07
 Limit (Pst): 1.00
Long-term Flicker (Plt): 0.07
 Limit (Plt): 0.65
Maximum Relative Volt. Change (dmax): 0.00%
 Limit (dmax): 4.00%
Relative Steady-state Voltage Change (dc): 0.04%
 Limit (dc): 3.30%
Maximum Interval exceeding 3.30% (dt): 0.00ms
 Limit (dt>Lim): 500ms

Flicker Emission - IEC 61000-3-3 , EN 61000-3-3 , (EN60555-3)

2011/5/23 PM 05:02:2

U_{rms} = 229.7 V P = 157.9 W
 I_{rms} = 0.827 A pf = 0.831

Range: 2 A
 V_{nom}: 230 V
 TestTime: 10 min (100%)

Test completed, Result: PASSED

HAR-1000 EMC-Retrie

120Min

Flickermeter 1000-4-15 for 230V/50Hz

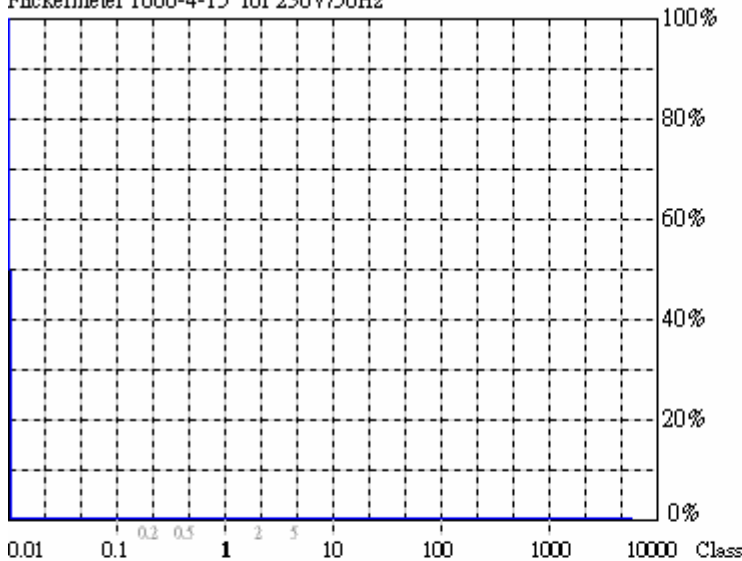

Actual Flicker (Fli): 0.00
Short-term Flicker (Pst): 0.07
 Limit (Pst): 1.00
Long-term Flicker (Plt): 0.07
 Limit (Plt): 0.65
Maximum Relative Volt. Change (dmax): 0.00%
 Limit (dmax): 4.00%
Relative Steady-state Voltage Change (dc): 0.04%
 Limit (dc): 3.30%
Maximum Interval exceeding 3.30% (dt): 0.00ms
 Limit (dt>Lim): 500ms

Flicker Emission - IEC 61000-3-3 , EN 61000-3-3 , (EN60555-3)

2011/5/23 PM 07:05:2

U_{rms} = 229.7 V P = 156.6 W
 I_{rms} = 0.820 A pf = 0.831

Range: 2 A
 V_{nom}: 230 V
 TestTime: 120 min (10000%)

Test completed, Result: PASSED

HAR-1000 EMC-Retrie

14. Appendix

14.1 Appendix A: Test Equipment

14.1.1 Test Equipment List

Location CON01	Equipment Name	Brand	Model	S/N	Last Cal. Date	Next Cal. Date
Conduction	Coaxial Cable 1F-C1	EMEC	5D Cable	1F-C1	10/25/2010	10/25/2011
Conduction	LISN 02	EMCO	3825/2	1407	07/22/2010	07/22/2011
Conduction	LISN 03	R&S	ESH3-Z5 831.5518.52	828874/010	07/22/2010	07/22/2011
Conduction	ISN T2 03	FCC	FCC-TLISN-T 2-02	20618	08/23/2010	08/23/2011
Conduction	ISN T4 05	FCC	FCC-TLISN-T 4-02	20619	08/23/2010	08/23/2011
Conduction	ISN T8 03	FCC	FCC-TLINS-T 8-02	20620	08/23/2010	08/23/2011
Conduction	EMI Receiver 15	ROHDE & SCHWARZ	ESCI	101166	04/19/2011	04/19/2012

Location OATS01	Equipment Name	Brand	Model	S/N	Last Cal. Date	Next Cal. Date
Radiation	BILOG Antenna 10	Sumol Sciences	JB1	A013004-1	07/22/2010	07/22/2011
Radiation	Coaxial Cable 3F-10M	EMCI	CFD400-NL	ISL-R001	03/15/2011	03/15/2012
Radiation	Coaxial Cable 3F-3M	BELDEN	RG-8/U	3F-3M	10/25/2010	10/25/2011
Radiation	EMI Receiver 13	ROHDE & SCHWARZ	ESCI	101015	02/17/2011	02/17/2012

Location Chamber14	Equipment Name	Brand	Model	S/N	Last Cal. Date	Next Cal. Date
Rad. Above 1GHz (Chamber14)	Horn Antenna 06	ETS	3117	00066665	09/28/2010	09/28/2011
Rad. Above 1GHz (Chamber14)	Horn Antenna 04	Com-Power	AH-826	081-001	05/04/2011	05/04/2012
Rad. Above 1GHz (Chamber14)	Horn Antenna 05	Com-Power	AH-640	100A	01/11/2011	01/10/2013
Rad. Above 1GHz (Chamber14)	SUCOFLEX 1GHz~18GHz cable	HUBER SUHNER	Sucoflex 106	67618/6 and 67619/6	02/09/2011	02/09/2012
Rad. Above 1GHz (Chamber14)	Preamplifier 15	Agilent	8449B	3008A2471	02/16/2011	02/16/2012
Rad. Above 1GHz (Chamber14)	Preamplifier 13	MITEQ	JS44-0010180 0-25-10P-44	1329256	06/10/2011	06/10/2012
Rad. Above 1GHz (Chamber14)	Spectrum Analyzer 19	R&S	FSP40	100116	10/18/2010	10/18/2011
Rad. Above 1GHz (Chamber14)	Spectrum Analyzer 20	Agilent Technologies	E4443A	MY48250315	05/12/2011	05/11/2012
Rad. Above 1GHz (Chamber14)	RF.Pre-selector 01	Agilent Technologies	N9039A	MY46520296	05/12/2011	05/11/2012
Rad. Above 1GHz	SUCOFLEX 1GHz~26.5GHz cable	HUBER+SUHNER AG.	Sucoflex 104	286305/4	09/30/2010	09/30/2011

Location	Equipment Name	Brand	Model	S/N	Last Cal. Date	Next Cal. Date
Immunity01						
EN61K-3-2/3	DC Burn-In Load 02	D-RAM	DBS-2100	2100-910027	N/A	N/A
EN61K-3-2/3	Harmonic/Flicker Test System 03	EMC Partner	HARMONICS-1000	178	03/29/2011	03/29/2012
EN61K-4-,4,5,8,11	TRANSIENT 2000 01	EMC Partner	TRANSIENT-2000	950	12/01/2010	12/01/2011
EN61K-4-2	ESD GUN 04	Schaffner	NSG 438	489	03/23/2011	03/23/2012
EN61K-4-3	BILOG Antenna 06	Schaffner	CBL6112B	2754	N/A	N/A
EN61K-4-3	Amplifier 80Mz~1GHz 250W	AR	250W1000A	312494	N/A	N/A
EN61K-4-3	Amplifier 800MHz~3.0GHz 60W	AR	60S1G3	312762	N/A	N/A
EN61K-4-3	Broadband coupler 10K~220Mhz	Amplifier Research	DC2500	19810	N/A	N/A
EN61K-4-3	Broadband Coupler 80M~1GHz	Amplifier Research	DC6180	20364	N/A	N/A
EN61K-4-3	Broadband Coupler 1~4GHz	Werlatone	C5291	6516	N/A	N/A
EN61K-4-3	Coaxial Cable Chmb 04-3M-2	Belden	RG-8/U	Chmb 04-3M-2	N/A	N/A
EN61K-4-3	Signal Generator 03	Anritsu	MG3642A	6200162550	03/18/2011	03/18/2012
EN61K-4-4	Digital Oscilloscope	Tektronix	TDS 684A	B010761	N/A	N/A
EN61K-4-4	EFT Clamp	Precision	1604242	CNEFT1000-103	N/A	N/A
EN61K-4-5	CDN-UTP8 01	EMC Partner	CDN-UTP8	032	12/01/2010	12/01/2011
EN61K-4-5	SURGE-TESTER 01	EMC Partner	MIG0603IN3	778	12/01/2010	12/01/2011
EN61K-4-6	6dB Attenuator	Weinschel Corp	33-6-34	BC5975	N/A	N/A
EN61K-4-6	Amplifier 4-6	Amplifier Research	150A100	1-1-R-02157	N/A	N/A
EN61K-4-6	Attenuator 6dB 4-6	BIRO	100-A-FFN-06	0123	N/A	N/A
EN61K-4-6	CDN M2+M3	Frankonia	M2+M3	A3011016	07/22/2010	07/22/2011
EN61K-4-6	CDN T2 01	Frankonia	T2	A3010003	07/22/2010	07/22/2011
EN61K-4-6	CDN T4 05	FCC Inc.	FCC-801-T4-R J45	08020	08/20/2010	08/20/2011
EN61K-4-6	CDN T8 01	FCC Inc.	FCC-801-T8-R J45	08021	08/20/2010	08/20/2011
EN61K-4-6	EM-Clamp 01	FCC	F-203I-23MM	539	N/A	N/A
EN61K-4-6	Coaxial Cable 4-6 01-1	Harbour Industries	M17/128-RG4 00	4-6 01-1	N/A	N/A
EN61K-4-6	Coaxial Cable 4-6 01-2	Harbour Industries	M17/128-RG4 00	4-6 01-2	N/A	N/A
EN61K-4-6	Coaxial Cable 4-6 01-3	Harbour Industries	M17/128-RG4 00	4-6 01-3	N/A	N/A
EN61K-4-6	KAL-AD RJ45S	BIRO			N/A	N/A
EN61K-4-6	KAL-AD T2	BIRO			N/A	N/A
EN61K-4-6	Passive Impedance Adaptor 4-6	FCC	FCC-801-150-50-CDN	9758;9759	N/A	N/A
EN61K-4-6, CISPR 13, Antenna	Signal Generator 02	HP	8648B	3642U01040	06/24/2011	06/24/2012
EN61K-4-8	Clamp Meter 4-8	TES	3090	990900322	07/30/2010	07/30/2011
EN61K-4-8	Magnetic Field Antenna	Precision	TRAIZ44B	MF1000-23	N/A	N/A

PS: N/A => The equipment does not need calibration.

14.1.2 Software for Controlling Spectrum/Receiver and Calculating Test Data

Test Item	Filename	Version
EN61000-3-2	HARCS.EXE	4.16
EN61000-3-3	HARCS.EXE	4.16
EN61000-4-3	Tile.Exe	2.0.P
EN61000-4-6	EN61000-4-6 Application Software	1.13.e
EN61000-4-2	N/A	2.0
EN61000-4-4	Tema.EXE	1.69
EN61000-4-5	Tema.EXE	1.69
EN61000-4-8	N/A	
EN61000-4-11	VDS-2002Rs.EXE	2.00

Radiation/Conduction	Filename	Version	Issued Date
Hsichih Conduction	EZ EMC	1.1.4.2	2/10/2007
Hsichih Radiation	EZ EMC	1.1.4.2	1/24/2007
Lung_Tan Radiation	EZ EMC	1.1.4.2	1/24/2007

14.2 Appendix B: Uncertainty of Measurement

The measurement uncertainty refers to CISPR 16-4-2:2003. The coverage factor $k = 2$ yields approximately a 95 % level of confidence.

<Conduction 01> ± 2.946 dB

<OATS 01 (10M)>

Horizontal

30MHz~200MHz: ± 4.216 dB

200MHz~1GHz: ± 4.438 dB

Vertical

30MHz~200MHz: ± 4.342 dB

200MHz~1GHz: ± 4.426 dB

<Chamber 14 (3M)>

1GHz~18GHz ± 3.722 dB

<Immunity 01>

Test item	Uncertainty
EN61000-4-2 (ESD)	
Voltage	$\pm 1.848\%$
First Peak current	$\pm 3.233\%$
current at 30ns	$\pm 3.272\%$
current at 60ns	$\pm 3.376\%$
EN61000-4-3 (RS)	± 1.776 dB
EN61000-4-4 (EFT)	
Time	$\pm 0.632\%$
Voltage	$\pm 1\%$
EN61000-4-5 (Surge)	
Time	$\pm 1.159\%$
Voltage	$\pm 1.633\%$
Current	$\pm 1.177\%$
EN61000-4-6 (CS)	± 1.892 dB
EN61000-4-8 (Magnetic)	$\pm 1.165\%$
EN61000-4-11 (Dips)	
Time	$\pm 1.159\%$
Voltage	$\pm 1.414\%$
Current	$\pm 1.177\%$
EN61000-3-2 (Harmonics)	$\pm 1.224\%$
EN61000-3-3 (Fluctuations and Flicker)	$\pm 1.224\%$

14.3 Appendix C: Photographs of EUT Configuration Test Set Up

14.3.1 Photo of Main Power Port Conducted Emission and Telecommunication Port Conducted Emission Measurement

Front View



Back View

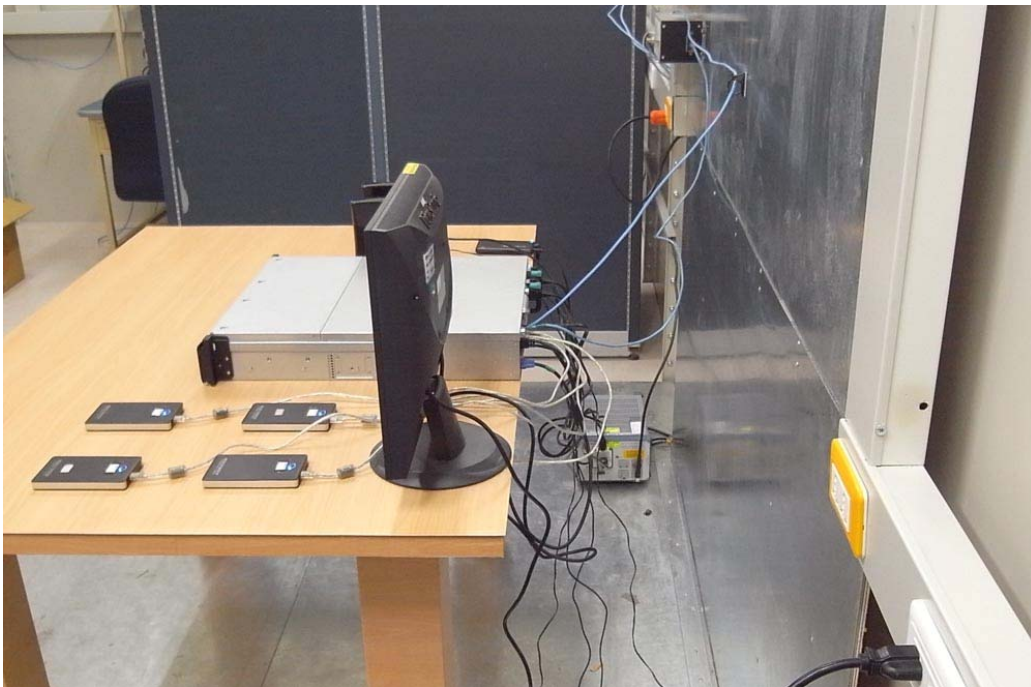
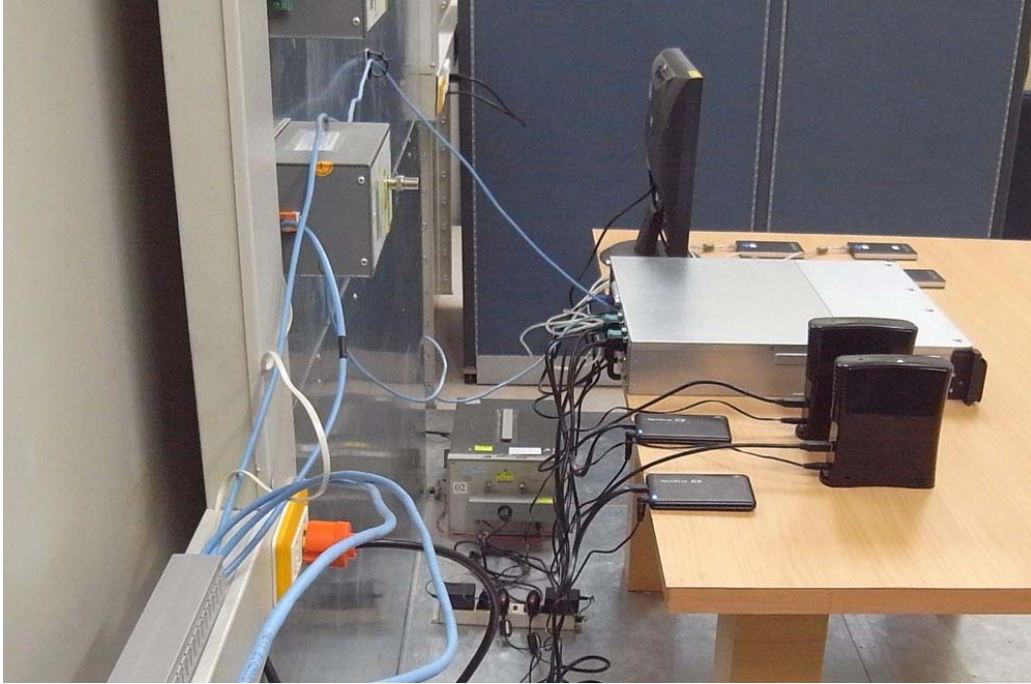

14.3.2 Photo of Radiated Emission Measurement

Front View (30MHz~1GHz)



Back View (30MHz~1GHz)



14.3.3 Photo of ESD Measurement



14.3.4 Photo of RF Field Strength Susceptibility Measurement

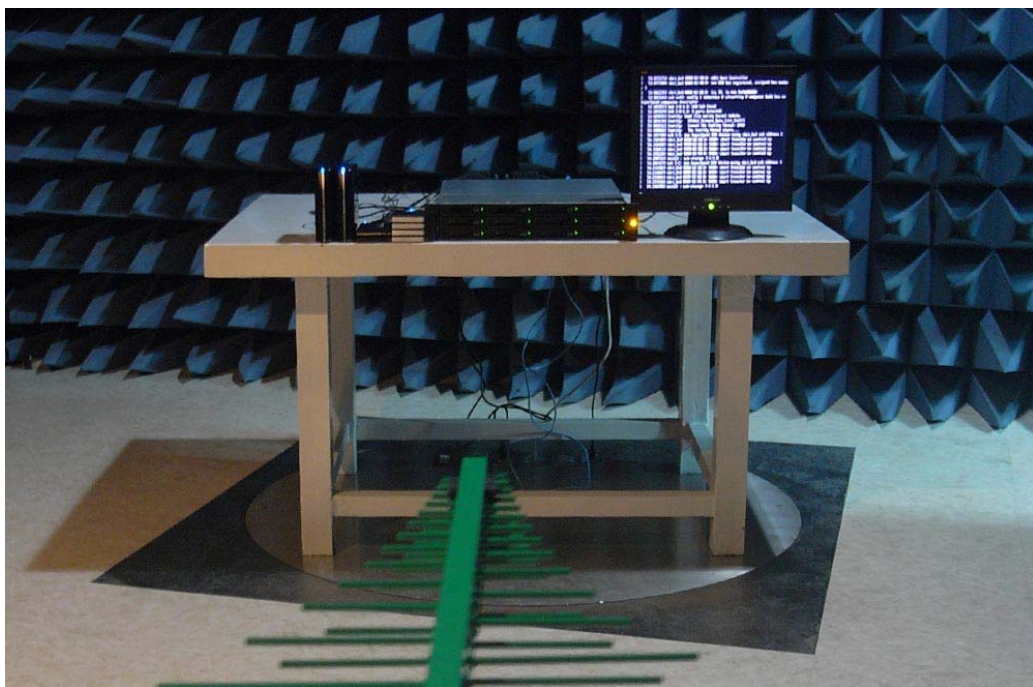

14.3.5 Photo of Electrical Fast Transient/Burst Measurement

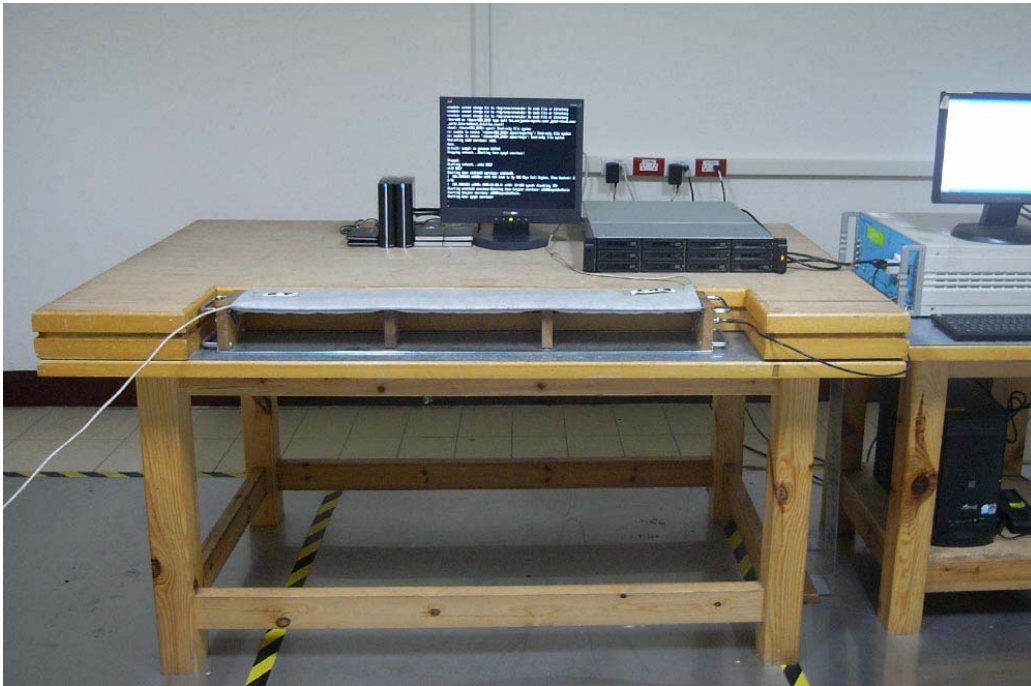

14.3.6 Photo of Surge Measurement

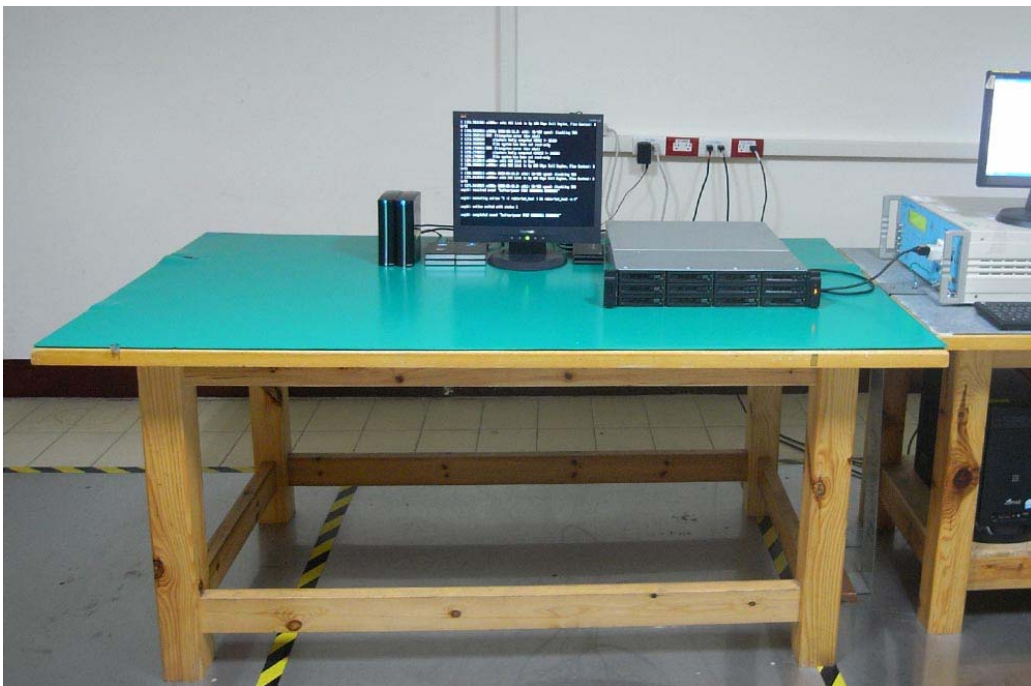

14.3.7 Photo of Conductive Measurement



14.3.8 Photo of Magnetic field Measurement

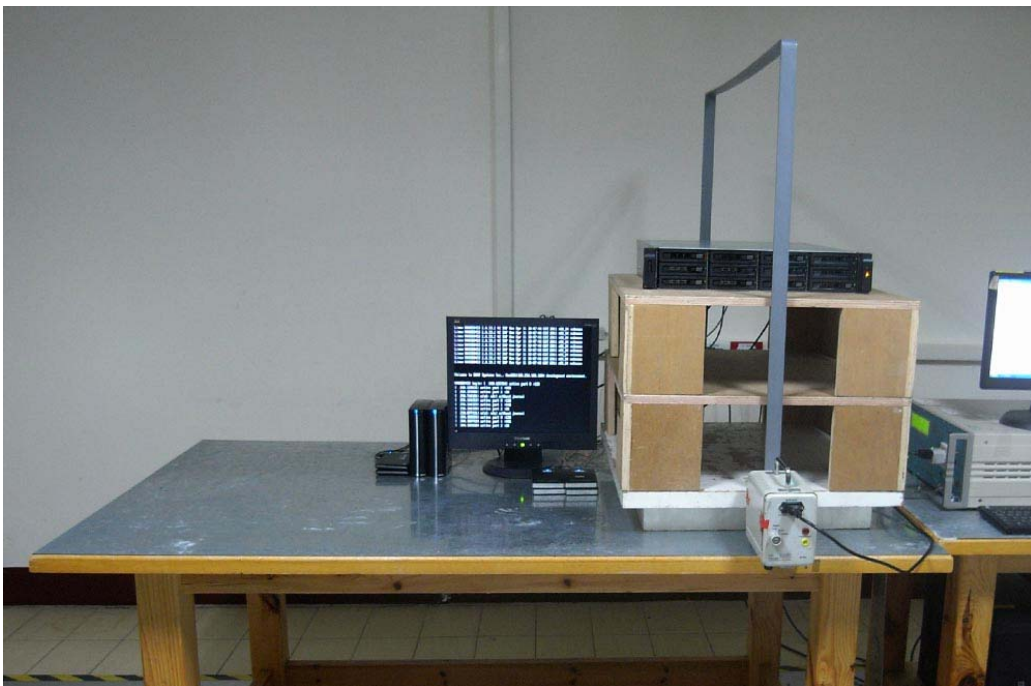

14.3.9 Photo of Voltage Dips Measurement

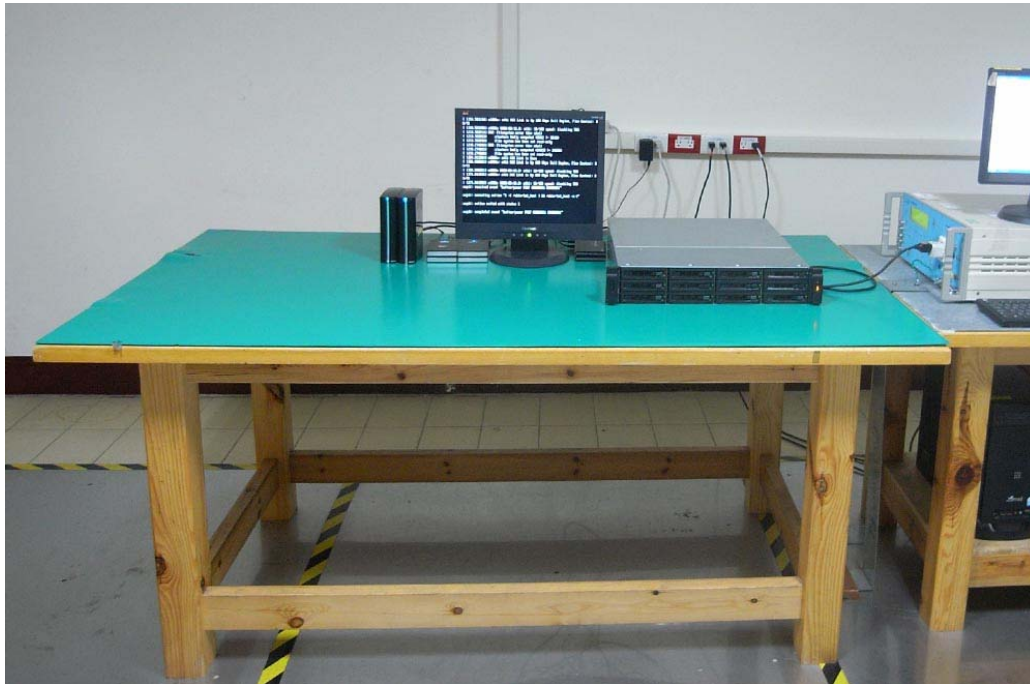

14.3.10 Photo of Harmonics and Voltage Fluctuations



14.4 Appendix D: Photographs of EUT

Please refer to the File of ISL-11HE173P